

Motori brushless CC Brushless DC motors

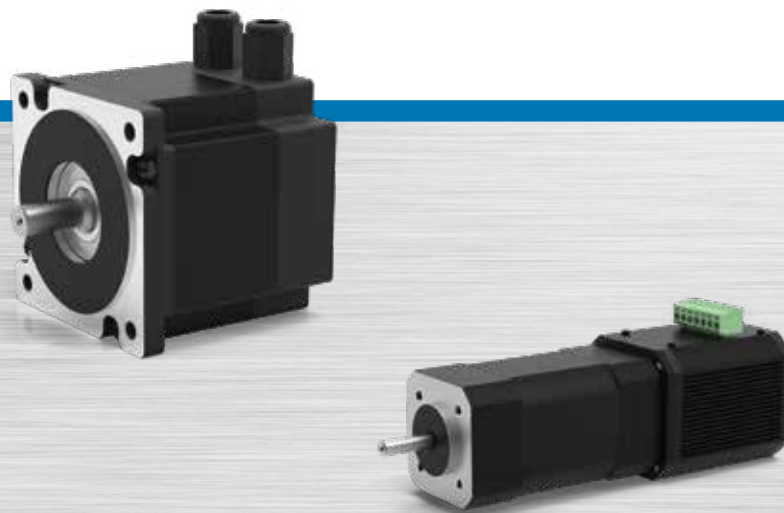

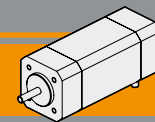

	Indice	Index	Pag. Page
	Caratteristiche tecniche	<i>Technical features</i>	E2
	Grado di protezione IP	<i>IP enclosures protection indexes</i>	E2
	Classe di isolamento termico	<i>Insulation class</i>	E2
	Tipi di servizio IEC	<i>IEC duty cycle ratings</i>	E2
	Legenda / Glossario dei grafici	<i>Key / Diagram Glossary</i>	E3
	Formule utili	<i>Useful formulas</i>	E3
BL005.240	Specifiche costruttive	<i>General features</i>	E4
BL005.240-IE	Prestazioni	<i>Performances</i>	E4
	Dimensioni	<i>Dimensions</i>	E5
	Diagramma dei collegamenti	<i>Connection diagram</i>	E5
BL012.240	Specifiche costruttive	<i>General features</i>	E6
BL012.240-IE	Prestazioni	<i>Performances</i>	E6
	Dimensioni	<i>Dimensions</i>	E7
	Diagramma dei collegamenti	<i>Connection diagram</i>	E7
BL018.240	Specifiche costruttive	<i>General features</i>	E8
BL018.240-IE	Prestazioni	<i>Performances</i>	E8
	Dimensioni	<i>Dimensions</i>	E9
	Diagramma dei collegamenti	<i>Connection diagram</i>	E9
BL025.24E	Specifiche costruttive	<i>General features</i>	E10
	Prestazioni	<i>Performances</i>	E10
	Dimensioni	<i>Dimensions</i>	E11
	Diagramma dei collegamenti	<i>Connection diagram</i>	E11
BL032.240	Specifiche costruttive	<i>General features</i>	E12
BL032.240-IE	Prestazioni	<i>Performances</i>	E12
	Dimensioni	<i>Dimensions</i>	E13
	Diagramma dei collegamenti	<i>Connection diagram</i>	E13
BL043.240	Specifiche costruttive	<i>General features</i>	E14
BL043.240-IE	Prestazioni	<i>Performances</i>	E14
	Dimensioni	<i>Dimensions</i>	E15
	Diagramma dei collegamenti	<i>Connection diagram</i>	E15
BL070.48E	Specifiche costruttive	<i>General features</i>	E16
	Prestazioni	<i>Performances</i>	E16
	Dimensioni	<i>Dimensions</i>	E17
	Diagramma dei collegamenti	<i>Connection diagram</i>	E17

Questa sezione annulla e sostituisce ogni precedente edizione o revisione. Qualora questa sezione non Vi sia giunta in distribuzione controllata, l'aggiornamento dei dati ivi contenuto non è assicurato. **In tal caso la versione più aggiornata è disponibile sul nostro sito internet www.intecno-srl.com**

This section replaces any previous edition and revision. If you obtained this catalogue other than through controlled distribution channels, the most up to date content is not guaranteed. In this case the latest version is available on our web site www.intecno-srl.com

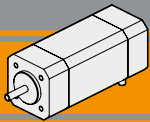

Caratteristiche tecniche

Technical features

I motori brushless cc della serie BL vengono realizzati in 5 taglie con coppie da 22 mNm a 0.7 Nm, e possono essere forniti con driver integrato (versione IE) o con driver esterno. I vantaggi di utilizzare i motori brushless anziché i tradizionali motori cc a spazzole, sono i seguenti:

- Lunga durata nel tempo
- Elevata efficienza
- Commutazione elettronica e controllo del motore tramite sensori digitali (encoder, resolver ecc..)
- Ampio campo di regolazione della velocità
- Mancanza di manutenzione

I motori della serie BL sono estremamente compatti e grazie al basso momento di inerzia offrono una elevata prestazione dinamica, ed inoltre sono economici in quanto dotati di sensori di Hall (anziché encoder o resolver).

Le 3 fasi dell'avvolgimento del motore sono a bassa tensione 24V / 36V / 48V e quindi offrono maggiori garanzie in termini di sicurezza dell'impianto, soprattutto nelle applicazioni dove l'operatore può essere a contatto con il motore stesso.

Inoltre l'utilizzo dell'elettronica integrata, **versione opzionale IE**, per il controllo della velocità permette di semplificare in modo sostanziale il cablaggio dell'impianto, riducendo anche gli spazi nei quadri di comando.

Brushless DC motors from the BL range are available in 5 sizes with torque from 22 mNm to 0.7Nm and they can be supplied with either an integrated (version IE) or external driver.

The advantages of using brushless motors instead of traditional DC brush motors are the following:

- Longer life time
- Higher efficiency
- Electronic commutation and control of the motor via digital sensors (encoder, resolver etc.)
- Wide speed range
- Maintenance free

BL motors have a compact design and thanks to low inertia they have high performances and are a low cost solution already including Hall sensors, as opposed to an encoder or resolver.

The 3 phase windings of the motor have a low voltage of 24/36/48 V and so these motors are safer to use when a machine operator has direct contact with them.

Furthermore, by using the integrated speed controller, **optional IE solution**, the cables of the equipment can be simplified taking up less space in the electric cabinet.

Grado di protezione IP

IP enclosures protection indexes

Indica il grado di isolamento meccanico del corpo motore.

1^a cifra protezione alla penetrazione di corpi solidi.

2^a cifra protezione contro la penetrazione d'acqua.

Indicates the degree of mechanical insulation of the motor body. 1st figure indicating level of protection against the penetration of solid bodies.

2nd figure: indicating degree to which the motor is waterproof.

2	Protetto da corpi solidi superiori a Ø 12 mm. <i>Protected against solid matters (over Ø 12 mm)</i>	0	Non protetto / No protection
3	Protetto da corpi solidi superiori a Ø 2,5 mm. <i>Protected against solid matters (over Ø 2,5 mm)</i>		

Classe di isolamento termico

Insulation class

Classe / Class	Δt °C Temp. ambiente: 40°C <i>Ambient temperature: 40°C</i>
B	90°C

Tipi di servizio IEC

IEC duty cycle ratings

S1	Servizio continuo. Funzionamento a carico costante per una durata sufficiente al raggiungimento dell' equilibrio termico.	Continuous duty. The motor works at a constant load for enough time to reach temperature equilibrium
S2	Servizio di durata limitata. Funzionamento a carico costante per una durata inferiore a quella necessaria al raggiungimento dell' equilibrio termico, seguito da un periodo di riposo tale da riportare il motore alla temperatura ambiente.	Short time duty. The motor works at a constant load, but not long enough to reach temperature equilibrium, and the rest periods are long enough for the motor to reach ambient temperature.
S3	Servizio periodico intermittente. Sequenze di cicli identici di marcia e di riposo a carico costante, senza raggiungimento dell' equilibrio termico. La corrente di spunto ha effetti trascurabili sul surriscaldamento del motore.	Intermittent periodic duty. Sequential, identical run and rest cycles with constant load. Temperature equilibrium is never reached. Starting current has little effect on temperature rise.

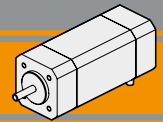

Legenda / Glossario dei grafici

Key / Diagram Glossary

Dato un motore brushless cc, la velocità di rotazione è funzione lineare della coppia; così pure la corrente assorbita è una funzione lineare della coppia. Velocità e corrente variano in maniera sensibile al variare del carico.

With a brushless motor, the rotational speed is a linear function of the torque. In the same way, the absorbed current is also a linear function of the torque. Speed and current change a lot against applied torque.

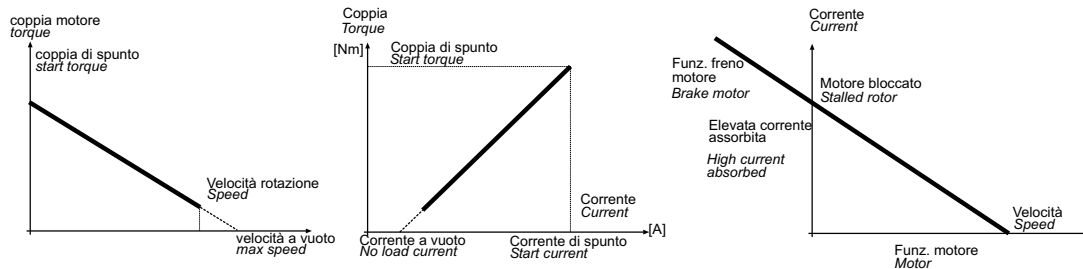

La potenza utile (potenza all' albero) si ricava dalla formula:

$$P_n [W] = M_n \cdot S = \frac{2\pi}{60} \cdot n_1 \cdot M_n$$

The output power is calculated using the formula:

$$P_n [W] = M_n \cdot S = \frac{2\pi}{60} \cdot n_1 \cdot M_n$$

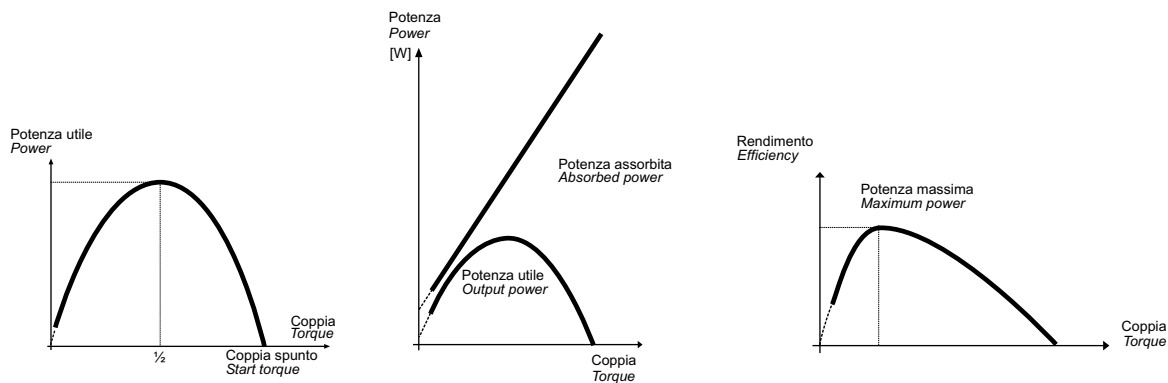

Poiché la tensione di alimentazione è costante mentre la corrente è linearmente crescente al crescere della coppia, l'andamento della potenza assorbita è una retta crescente. Dal rapporto tra la potenza meccanica e la potenza assorbita si ottiene il grafico dell'efficienza.

Since the supply voltage is constant, whereas the current increases in a linear manner as the torque increases, the absorbed power trend is a straight line going up. Efficiency is shown from the ratio between the output power and the absorbed power.

Formule utili

Useful formulas

$$\eta = \frac{P_n}{P_a}$$

$$P_a = V \cdot I$$

$$P_n = V \cdot I \cdot \eta$$

$$P_n = M_n \cdot S_v$$

$$S_v = \frac{n_1}{9.55}$$

$$\eta = \frac{P_n}{P_a}$$

$$P_a = V \cdot I$$

$$P_n = V \cdot I \cdot \eta$$

$$P_n = M_n \cdot S_v$$

$$S_v = \frac{n_1}{9.55}$$

$$[HP] \cdot 746 = [W].$$

Esempio 2 HP = circa 1500 W.

$$[HP] \cdot 746 = [W].$$

Example 2 HP = approx. 1500 W.

S	—	Servizio	<i>Duty</i>
P_n	[W]	Potenza in uscita	<i>Rated power</i>
P_a	[W]	Potenza assorbita	<i>Absorbed power</i>
M_n	[Nm]	Coppia nominale	<i>Rated torque</i>
V	[V]	Tensione	<i>Voltage</i>
I	[A]	Corrente assorbita	<i>Absorbed current</i>
n₁	[min-1]	Numero giri motore	<i>Motor speed</i>
S_v	[rad/s]	Velocità angolare	<i>Angular speed</i>
IC	—	Classe d'isolamento termico	<i>Thermal insulation class</i>
FF	—	Fattore di forma	<i>Form factor</i>
IP	—	Classe di protezione	<i>protection class</i>
η	—	Rendimento	<i>Efficiency</i>
Kg	—	Peso	<i>Weight</i>

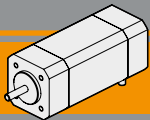

BL005.240 - BL005.240 -IE

Specifiche costruttive

General features

Tipologia di avvolgimento <i>Winding type</i>	Stella <i>Star</i>	Max forza radiale <i>Max radial force</i>	15N @ 10 mm dalla flangia <i>15N @ 10 mm from flange</i>
Angolo sensori Hall <i>HALL effect angle</i>	120 gradi elettrici <i>120 degree electrical angle</i>	Max forza assiale <i>Max axial force</i>	10N
Gioco radiale <i>Radial play</i>	0.02 mm @ 450g	Classe di isolamento termico <i>Insulation class</i>	Classe B <i>Class B</i>
Gioco assiale <i>End play</i>	0.08 mm @ 450g	Isolamento dielettrico <i>Dielectric strength</i>	500Vcc x 1 minuto <i>500 Vdc 1 minute</i>
Scentratura albero <i>Shaft run out</i>	0.025 mm	Resistenza isolamento <i>Insulation resistance</i>	100MΩ minimo, 500Vcc <i>100MΩ min, 500 Vdc</i>

Modello <i>Model</i>	Poli <i>Poles</i>	Fasi <i>Phases</i>	Tensione nominale <i>Rated voltage</i>	Velocità nominale <i>Rated speed</i>	Coppia nominale <i>Rated torque</i>	Potenza nominale <i>Rated power</i>	Coppia di picco <i>Peak torque</i>	Corrente nominale <i>Rated current</i>	Corrente di picco <i>Peak current</i>	Resistenza fase-fase <i>Line to line resistance</i>	Induttanza fase-fase <i>Line to line inductance</i>	Costante di coppia <i>Torque constant</i>	Costante FCEM <i>Back EMF</i>	Inerzia rotore <i>Rotor inertia</i>	Peso <i>Weight</i>	IP
			[V]	[min ⁻¹]	[mNm]	[W]	[mNm]	[A]	[A]	[Ω]	[mH]	[mNm/A]	[V/kRPM]	[gcm ²]	[kg]	
BL005.240	4	3	24	3700	50	16	150	1.0	3	4.2	2.2	50	5.23	5.98	0.208	30
BL005.240-IE	4	3	24	3000	22	7	44	0.55	1.1	9.5	4.8	40	—	5.98	0.220	30

Azionamenti
Drives



Prestazioni

Performances

BL005.240

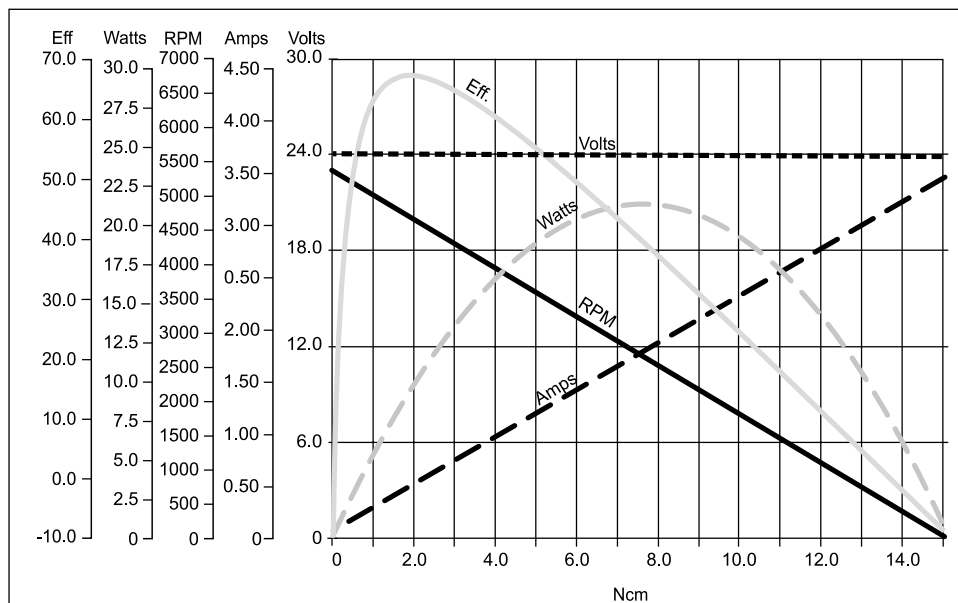

BL005.240-IE

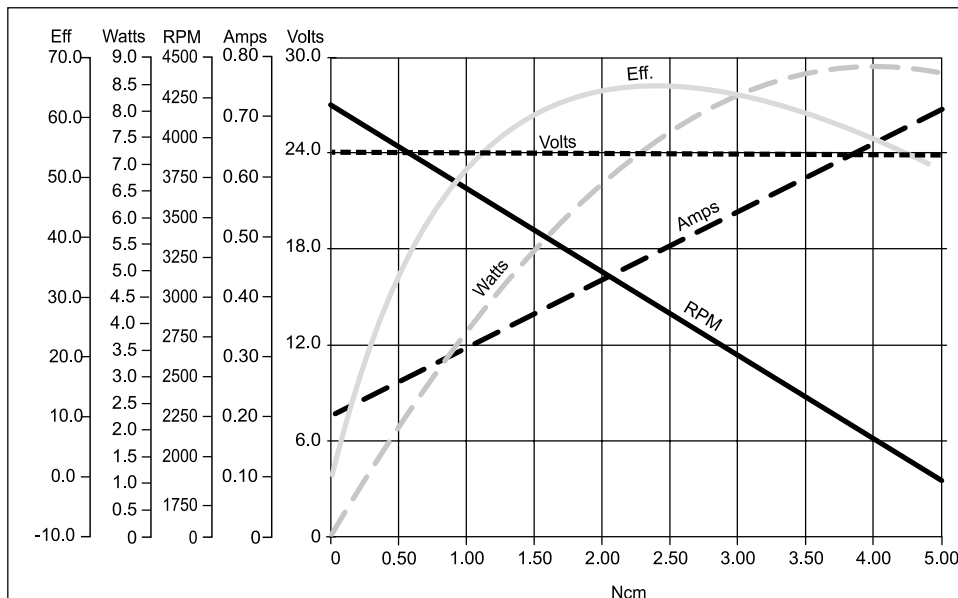

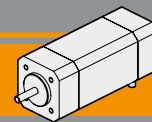

BL005.240 - BL005.240 -IE

Dimensioni

Dimensions

BL005.240

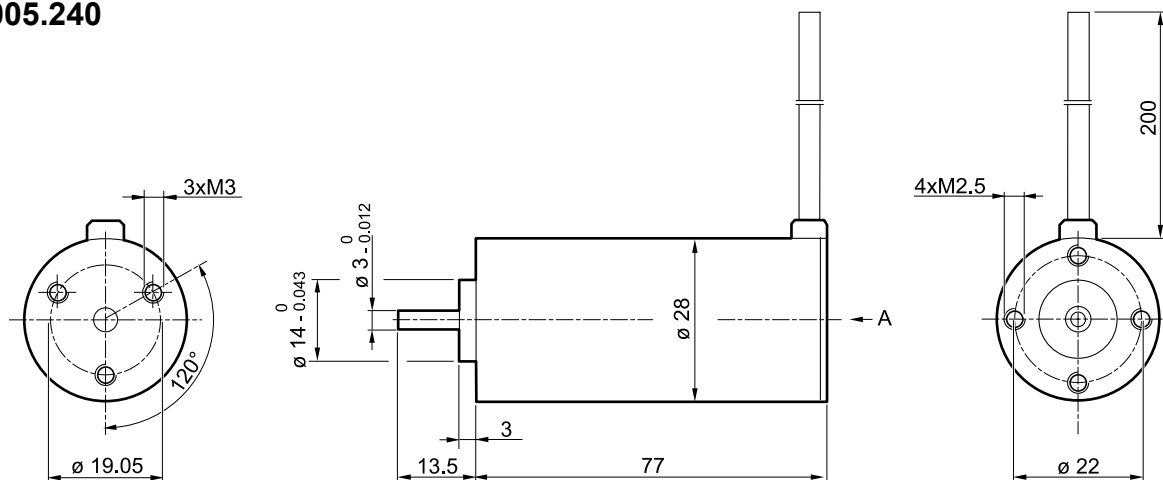

BL005.240-IE



Diagramma dei collegamenti

Connection diagram

BL005.240	
Cavi di potenza Power leads	Descrizione Description
Verde / Green	Fase U / U motor Phase
Rosso / Red	Fase V / V motor Phase
Nero / Black	Fase W / W motor Phase

Cavi di segnale Signal leads	Descrizione Description
Blue	HALL fase U U phase HALL
Arancione / Orange	HALL fase V V phase HALL
Marrone / Brown	HALL fase W W phase HALL
Giallo / Yellow	Alimentazione HALL + 5Vcc Supply voltage for Hall sensors, + 5 Vdc
Bianco / White	Comune per i segnali di HALL Ground for HALL sensors

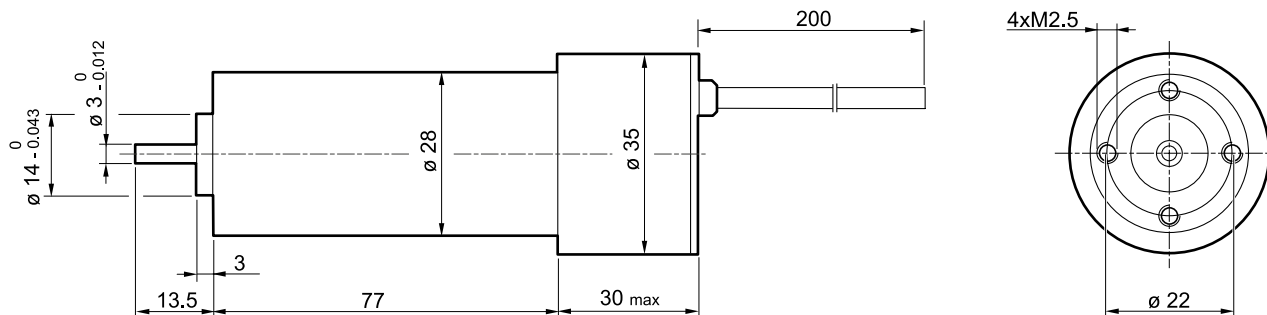
BL005.240-IE	
Cavi Leads	Descrizione Description
Rosso / Red	Alimentazione + 24Vcc Supply voltage +24Vdc
Blue	Comune sia di alimentazione che di segnale Power and signal ground
Bianco / White (*)	Ingresso setpoint di velocità Speed reference signal
Verde / Green	Selezione direzione, aperto oppure chiuso sul comune (cavo blue) Rotation selection, open or closed against the ground (blue)

Nota: Si raccomanda di seguire fedelmente gli schemi di collegamento qui riportati, pericolo di danneggiamento del motore o dell'elettronica.

Note: Pls, follow strictly the above connection diagrams, danger for the motor and the electric control

(*) Senza potenziometro velocità massima. Attivo da 3.5 V (velocità zero) a 1 Vcc (velocità massima). In assenza di alimentazione opportuna per il potenziometro, è possibile usare l'alimentazione 24 Vcc ma limitando superiormente il potenziometro con una resistenza adeguata onde impedire che entrino più di 5 Vcc nel cavo Bianco.

(*) Without speed pot, the motor runs at maximum speed. Motor active in range 3.5 Vdc (zero speed) down to 1 Vdc (max speed). If not available specific voltage, could be applied to speed pot 24 Vdc but using upper resistor to limit max voltage to white lead: no above 5 Vdc, pls.

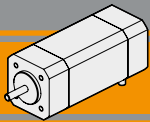

BL012.240 - BL012.240-IE

Specifiche costruttive

General features

Tipologia di avvolgimento <i>Winding type</i>	delta
Angolo sensori Hall <i>HALL effect angle</i>	120 gradi elettrici <i>120 degree electrical angle</i>
Gioco radiale <i>Radial play</i>	0.02 mm @ 450g
Gioco assiale <i>End play</i>	0.08 mm @ 450g
Scentratura albero <i>Shaft run out</i>	0.025 mm

Max forza radiale <i>Max radial force</i>	28N @ 20 mm dalla flangia <i>28N @ 20 mm from flange</i>
Max forza assiale <i>Max axial force</i>	10N
Classe di isolamento termico <i>Insulation class</i>	Classe B <i>Class B</i>
Isolamento dielettrico <i>Dielectric strength</i>	500Vcc x 1 minuto <i>500 Vdc 1 minute</i>
Resistenza isolamento <i>Insulation resistance</i>	100MΩ minimo, 500Vcc <i>100MΩ min, 500 Vdc</i>

Modello <i>Model</i>	Poli <i>Poles</i>	Fasi <i>Phases</i>	Tensione nominale	Velocità nominale	Coppia nominale	Potenza nominale	Coppia di picco	Corrente nominale	Corrente di picco	Resistenza fase-fase	Induttanza fase-fase	Costante di coppia	Costante FCEM	Inerzia rotore	Peso	IP
			Rated voltage	Rated speed	Rated torque	Rated power	Peak torque	Rated current	Peak current	Line to line resistance	Line to line inductance	Torque constant	Back EMF	Rotor inertia	Weight	
			[V]	[min ⁻¹]	[Nm]	[W]	[Nm]	[A]	[A]	[Ω]	[mH]	[Nm/A]	[V/kRPM]	[gcm ²]	[kg]	
BL012.240	8	3	24	4000	0.125	52	0.38	3.5	10.6	0.80	1.2	0.0355	3.72	48	0.45	30
BL012.240-IE	8	3	24	4000	0.125	52	0.25	3.5	7.1	0.80	1.2	0.0355	3.72	48	0.57	30

Azionamenti
Drives



Prestazioni

Performances

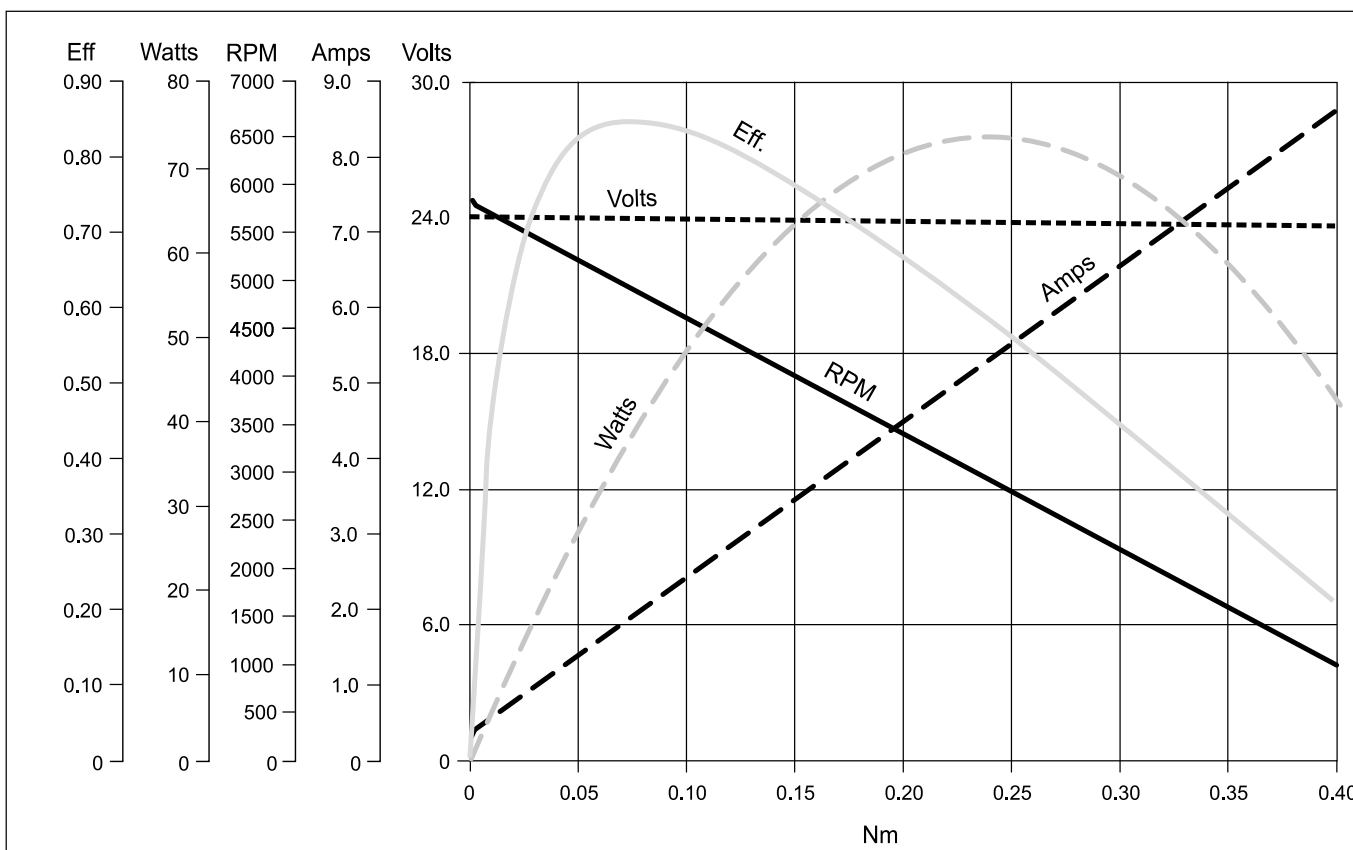

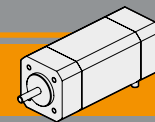

BL012.240 - BL012.240-IE

Dimensioni

Dimensions

BL012.240

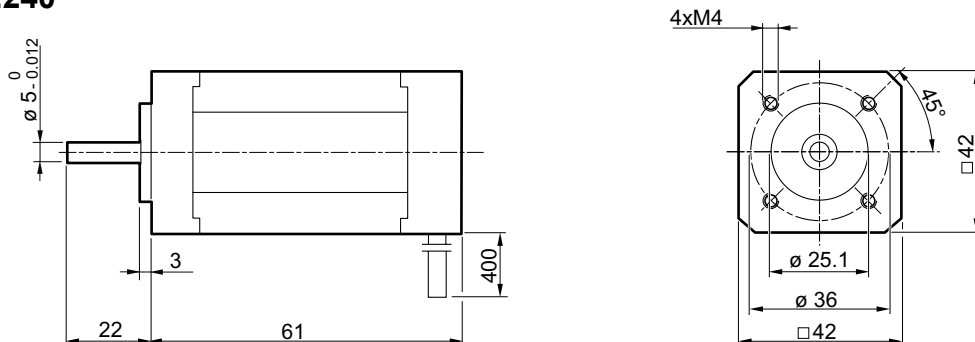

BL012.240-IE



Diagramma dei collegamenti

Connection diagram

BL012.240	
Cavi di potenza Power leads	Descrizione Description
Giallo / Yellow	Fase U / U motor Phase
Rosso / Red	Fase V / V motor Phase
Nero / Black	Fase W / W motor Phase

Cavi di segnale Signal leads	Descrizione Description
Blue	HALL fase U U phase HALL
Verde Green	HALL fase V V phase HALL
Bianco White	HALL fase W W phase HALL
Rosso (piccolo) Red (small)	Alimentazione HALL + 5Vcc Supply voltage for Hall sensors, + 5 Vdc
Nero (piccolo) Black (small)	Comune per i segnali di HALL Ground for HALL sensors

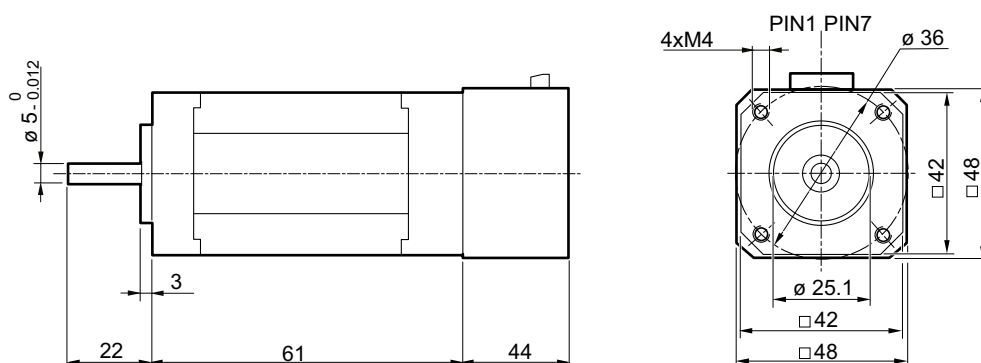
BL012.240-IE						
+5v	F/R	SV	PG	GND	-VP	+VP
1	2	3	4	5	6	7

7 +VP	Tensione positiva +24Vcc Power input +24VDC
6 -VP	Tensione negativa di alimentazione Power ground
5 GND	Riferimento comune per i segnali Common ground of system
4 PG	Impulsi per giro (24) Speed pulse output (TTL), 24 pulse/rev
3 SV	Potenziometro Speed voltage 0-5 VDC
2 F/R	Senso di marcia Rotating direction. Hi=CW
1 +5V	Tensione 5 Vcc in uscita +5V voltage output

Nota: Si raccomanda di seguire fedelmente gli schemi di collegamento qui riportati, pericolo di danneggiamento del motore o dell'elettronica.

Note: Pls, follow strictly the above connection diagrams, danger for the motor and the electric control

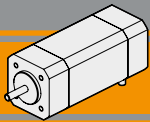

BL018.240 - BL018.240-IE

Specifiche costruttive

General features

Tipologia di avvolgimento <i>Winding type</i>	delta
Angolo sensori Hall <i>HALL effect angle</i>	120 gradi elettrici <i>120 degree electrical angle</i>
Gioco radiale <i>Radial play</i>	0.02 mm @ 450g
Gioco assiale <i>End play</i>	0.08 mm @ 450g
Scantatura albero <i>Shaft run out</i>	0.025 mm

Max forza radiale <i>Max radial force</i>	28N @ 20 mm dalla flangia <i>28N @ 20 mm from flange</i>
Max forza assiale <i>Max axial force</i>	10N
Classe di isolamento termico <i>Insulation class</i>	Classe B <i>Class B</i>
Isolamento dielettrico <i>Dielectric strength</i>	500Vcc x 1 minuto <i>500 Vdc 1 minute</i>
Resistenza isolamento <i>Insulation resistance</i>	100MΩ minimo, 500Vcc <i>100MΩ min, 500 Vdc</i>

Modello <i>Model</i>	Poli <i>Poles</i>	Fasi <i>Phases</i>	Tensione nominale	Velocità nominale	Coppia nominale	Potenza nominale	Coppia di picco	Corrente nominale	Corrente di picco	Resistenza fase-fase	Induttanza fase-fase	Costante di coppia	Costante FCEM	Inerzia rotore	Peso	IP
			<i>Rated voltage</i>	<i>Rated speed</i>	<i>Rated torque</i>	<i>Rated power</i>	<i>Peak torque</i>	<i>Rated current</i>	<i>Peak current</i>	<i>Line to line resistance</i>	<i>Line to line inductance</i>	<i>Torque constant</i>	<i>Back EMF</i>	<i>Rotor inertia</i>	<i>Weight</i>	
			[V]	[min ⁻¹]	[Nm]	[W]	[Nm]	[A]	[A]	[Ω]	[mH]	[Nm/A]	[V/kRPM]	[gcm ²]	[kg]	
BL018.240	8	3	24	4000	0.185	78	0.56	5	15.5	0.55	0.8	0.036	3.76	72	0.65	30
BL018.240-IE	8	3	24	4000	0.185	78	0.38	5	10.3	0.46	0.7	0.038	3.97	72	0.76	30

Azionamenti
Drives



Prestazioni

Performances

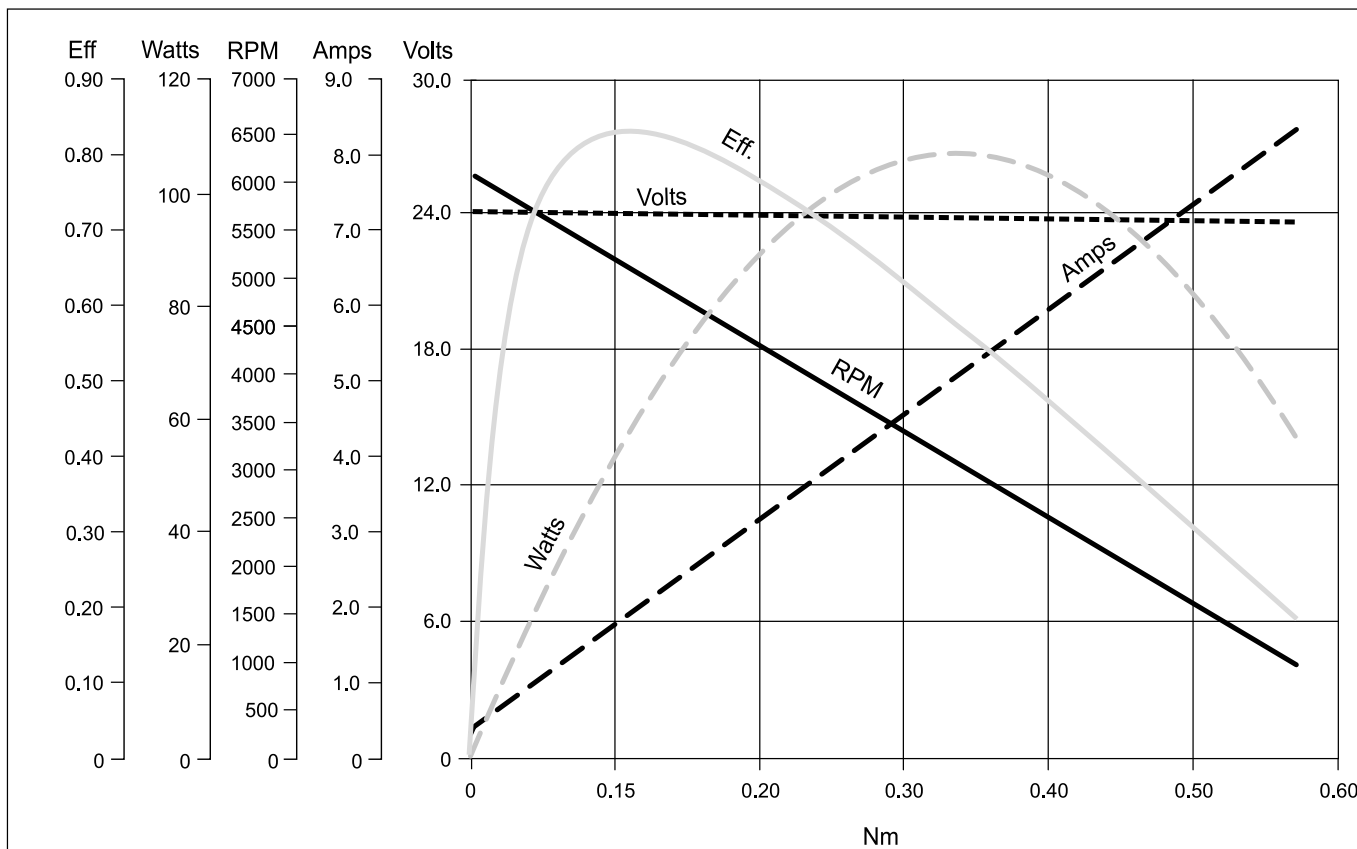

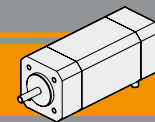

BL018.240 - BL018.240-IE

Dimensioni

Dimensions

BL018.240

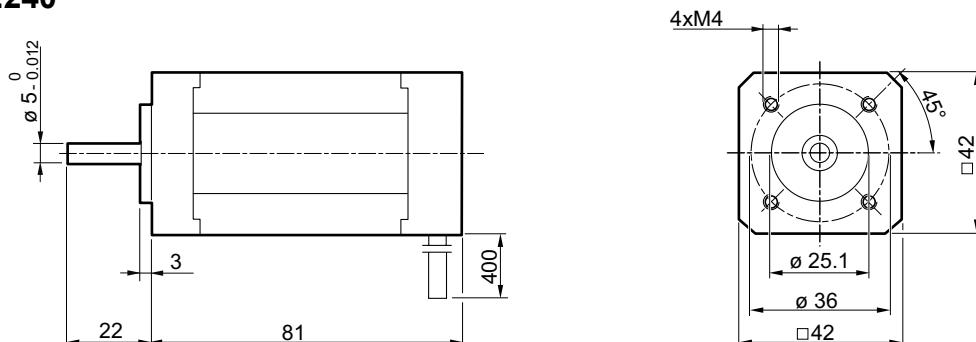

BL018.240-IE



Diagramma dei collegamenti

Connection diagram

BL018.240	
Cavi di potenza Power leads	Descrizione Description
Giallo / Yellow	Fase U / U motor Phase
Rosso / Red	Fase V / V motor Phase
Nero / Black	Fase W / W motor Phase

Cavi di segnale Signal leads	Descrizione Description
Blue	HALL fase U U phase HALL
Verde Green	HALL fase V V phase HALL
Bianco White	HALL fase W W phase HALL
Rosso (piccolo) Red (small)	Alimentazione HALL + 5Vcc Supply voltage for Hall sensors, + 5 Vdc
Nero (piccolo) Black (small)	Comune per i segnali di HALL Ground for HALL sensors

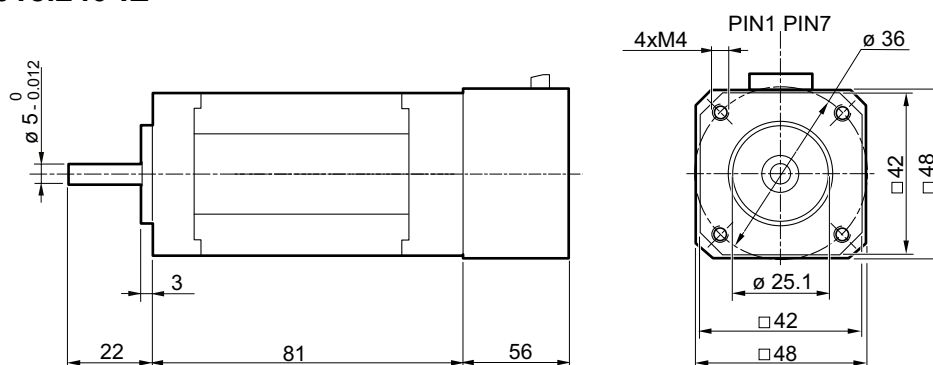
BL018.240-IE						
+5v	F/R	SV	PG	GND	-VP	+VP
1	2	3	4	5	6	7

7 +VP	Tensione positiva +24Vcc Power input +24VDC
6 -VP	Tensione negativa di alimentazione Power ground
5 GND	Riferimento comune per i segnali Common ground of system
4 PG	Impulsi per giro (24) Speed pulse output (TTL), 24 pulse/rev
3 SV	Potenziometro Speed voltage 0-5 VDC
2 F/R	Senso di marcia Rotating direction. Hi=CW
1 +5V	Tensione 5 Vcc in uscita +5V voltage output

Nota: Si raccomanda di seguire fedelmente gli schemi di collegamento qui riportati, pericolo di danneggiamento del motore o dell'elettronica.

Note: Pls, follow strictly the above connection diagrams, danger for the motor and the electric control

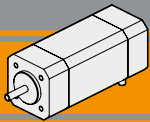

BL025.24E

Specifiche costruttive

General features

Tipologia di avvolgimento <i>Winding type</i>	delta	Max forza radiale <i>Max radial force</i>	28N @ 20 mm dalla flangia 28N @ 20 mm from flange
Angolo sensori Hall <i>HALL effect angle</i>	120 gradi elettrici 120 degree electrical angle	Max forza assiale <i>Max axial force</i>	10N
Gioco radiale <i>Radial play</i>	0.02 mm @ 450g	Classe di isolamento termico <i>Insulation class</i>	Classe B Class B
Gioco assiale <i>End play</i>	0.08 mm @ 450g	Isolamento dielettrico <i>Dielectric strength</i>	500Vcc x 1 minuto 500 Vdc 1 minute
Scenatura albero <i>Shaft run out</i>	0.025 mm	Resistenza isolamento <i>Insulation resistance</i>	100MΩ minimo, 500Vcc 100MΩ min, 500 Vdc

Modello Model	Poli Poles	Fasi Phases	Tensione nominale	Velocità nominale	Coppia nominale	Potenza nominale	Coppia di picco	Corrente nominale	Corrente di picco	Resistenza fase-fase	Induttanza fase-fase	Costante di coppia	Costante FCEM	Inerzia rotore	Peso	IP
			Rated voltage	Rated speed	Rated torque	Rated power	Peak torque	Rated current	Peak current	Line to line resistance	Line to line inductance	Torque constant	Back EMF	Rotor inertia	Weight	
			[V]	[min ⁻¹]	[Nm]	[W]	[Nm]	[A]	[A]	[Ω]	[mH]	[Nm/A]	[V/kRPM]	[gcm ²]	[kg]	
BL025.24E	8	3	24	4000	0.25	105	0.75	6.6	21	0.3	0.5	0.0376	3.9	96	0.8	30

Azionamenti
Drives



Prestazioni

Performances

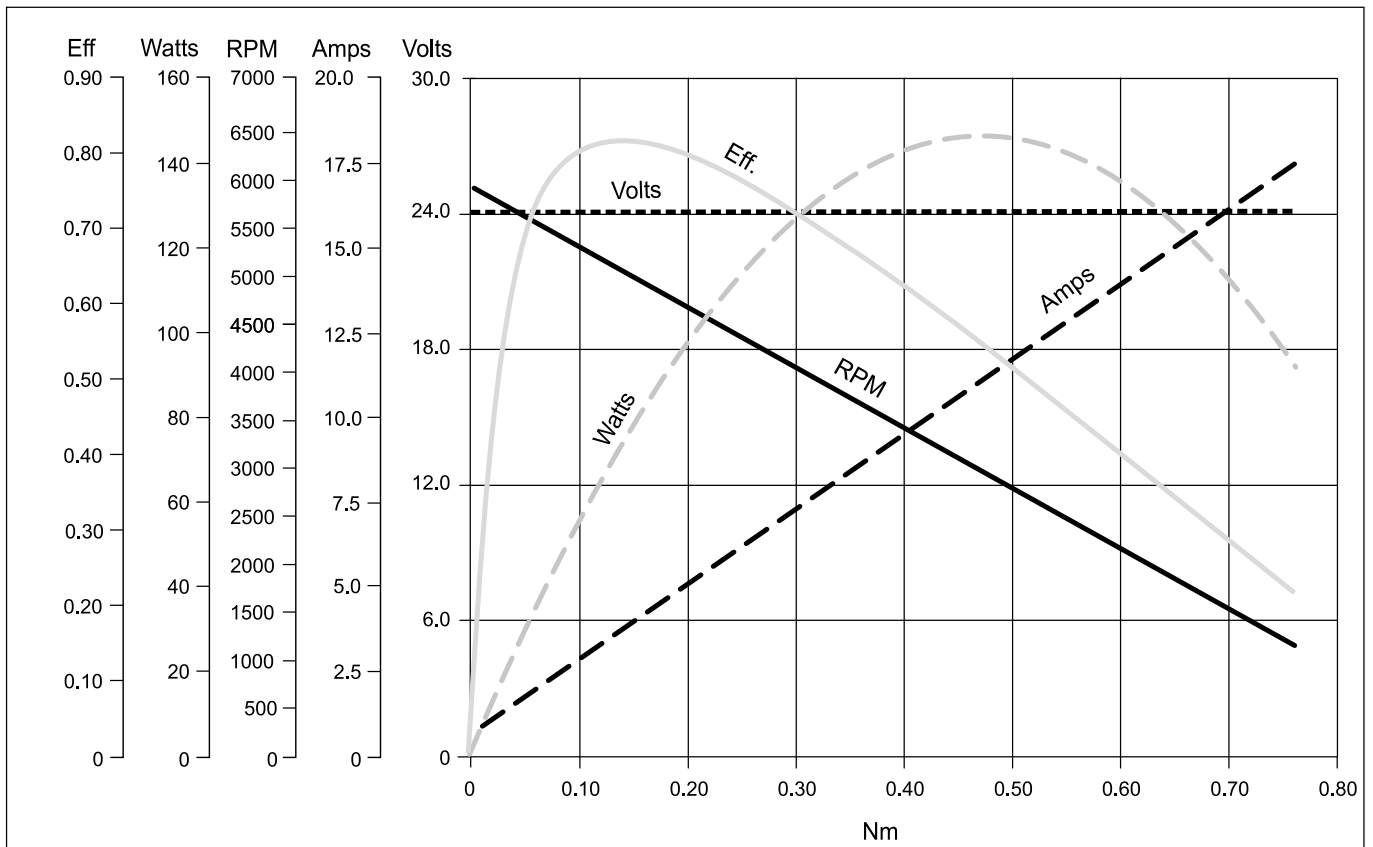

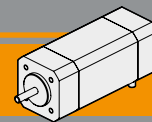

BL025.24E

Dimensioni

Dimensions

BL025.24E

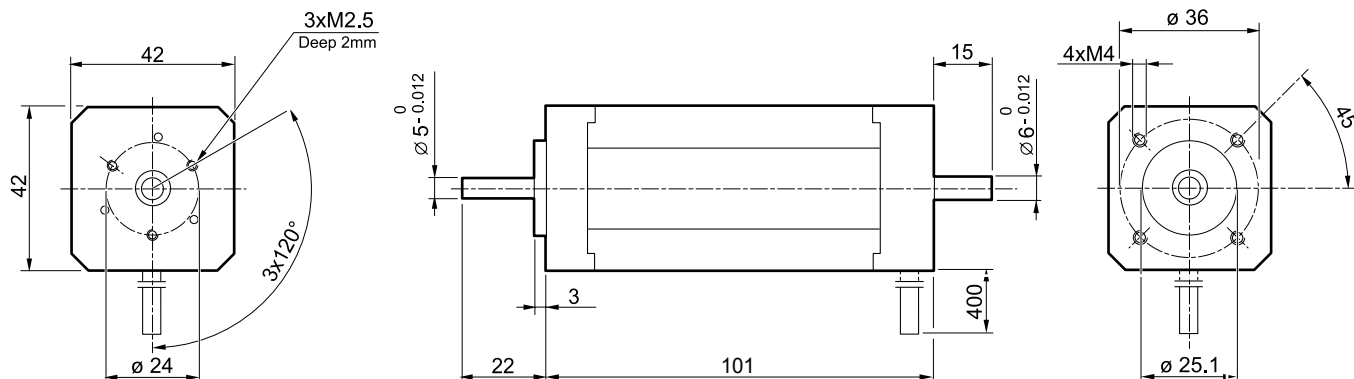

Encoder



Per montaggio encoder serve flangia AS 4M.305
Encoder assembling needs flange AS 4M.305



Diagramma dei collegamenti

Connection diagram

Cavi di potenza Power leads	Descrizione Description
Giallo / Yellow	Fase U / U motor Phase
Rosso / Red	Fase V / V motor Phase
Nero / Black	Fase W / W motor Phase

Cavi di segnale Signal leads	Descrizione Description
Blue	HALL fase U U phase HALL
Verde Green	HALL fase V V phase HALL
Bianco White	HALL fase W W phase HALL
Rosso (piccolo) Red (small)	Alimentazione HALL + 5Vcc Supply voltage for Hall sensors, + 5 Vdc
Nero (piccolo) Black (small)	Comune per i segnali di HALL Ground for HALL sensors

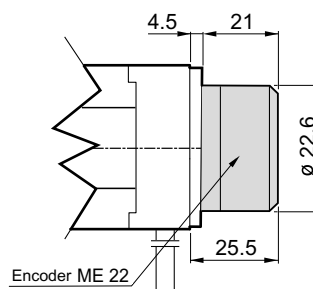
Nota: Si raccomanda di seguire fedelmente gli schemi di collegamento qui riportati, pericolo di danneggiamento del motore o dell'elettronica.

Note: Pls, follow strictly the above connection diagrams, danger for the motor and the electric control

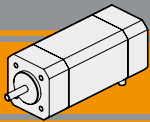

BL032.240 - BL032.240-IE

Specifiche costruttive

General features

Tipologia di avvolgimento <i>Winding type</i>	delta
Angolo sensori Hall <i>HALL effect angle</i>	120 gradi elettrici <i>120 degree electrical angle</i>
Gioco radiale <i>Radial play</i>	0.025 mm @ 460 g
Gioco assiale <i>End play</i>	0.025 mm @ 4000 g
Scentratura albero <i>Shaft run out</i>	0.025 mm

Max forza radiale <i>Max radial force</i>	75N @ 20 mm dalla flangia <i>75N @ 20 mm from flange</i>
Max forza assiale <i>Max axial force</i>	15N
Classe di isolamento termico <i>Insulation class</i>	Classe B <i>Class B</i>
Isolamento dielettrico <i>Dielectric strength</i>	500Vcc x 1 minuto <i>500 Vdc 1 minute</i>
Resistenza isolamento <i>Insulation resistance</i>	100MΩ minimo, 500Vcc <i>100MΩ min, 500 Vdc</i>

Modello <i>Model</i>	Poli <i>Poles</i>	Fasi <i>Phases</i>	Tensione nominale	Velocità nominale	Coppia nominale	Potenza nominale	Coppia di picco	Corrente nominale	Corrente di picco	Resistenza fase-fase	Induttanza fase-fase	Costante di coppia	Costante FCEM	Inerzia rotore	Peso	IP
			<i>Rated voltage</i>	<i>Rated speed</i>	<i>Rated torque</i>	<i>Rated power</i>	<i>Peak torque</i>	<i>Rated current</i>	<i>Peak current</i>	<i>Line to line resistance</i>	<i>Line to line inductance</i>	<i>Torque constant</i>	<i>Back EMF</i>	<i>Rotor inertia</i>	<i>Weight</i>	
			[V]	[min ⁻¹]	[Nm]	[W]	[Nm]	[A]	[A]	[Ω]	[mH]	[Nm/A]	[V/kRPM]	[gcm ²]	[kg]	
BL032.240	4	3	36	4000	0.32	135	1.0	5	16.5	0.45	1.4	0.063	6.6	173	1.0	20
BL032.240-IE	4	3	36	4000	0.32	135	0.64	5	11.0	0.45	1.65	0.061	6.3	173	1.18	30
BL032.240	4	3	24	3000	0.32	100	1.0	5	16.5	0.45	1.4	0.063	6.6	173	1.0	20
BL032.240-IE	4	3	24	3000	0.32	100	0.64	5	11.0	0.45	1.65	0.061	6.3	173	1.18	30



Prestazioni

Performances

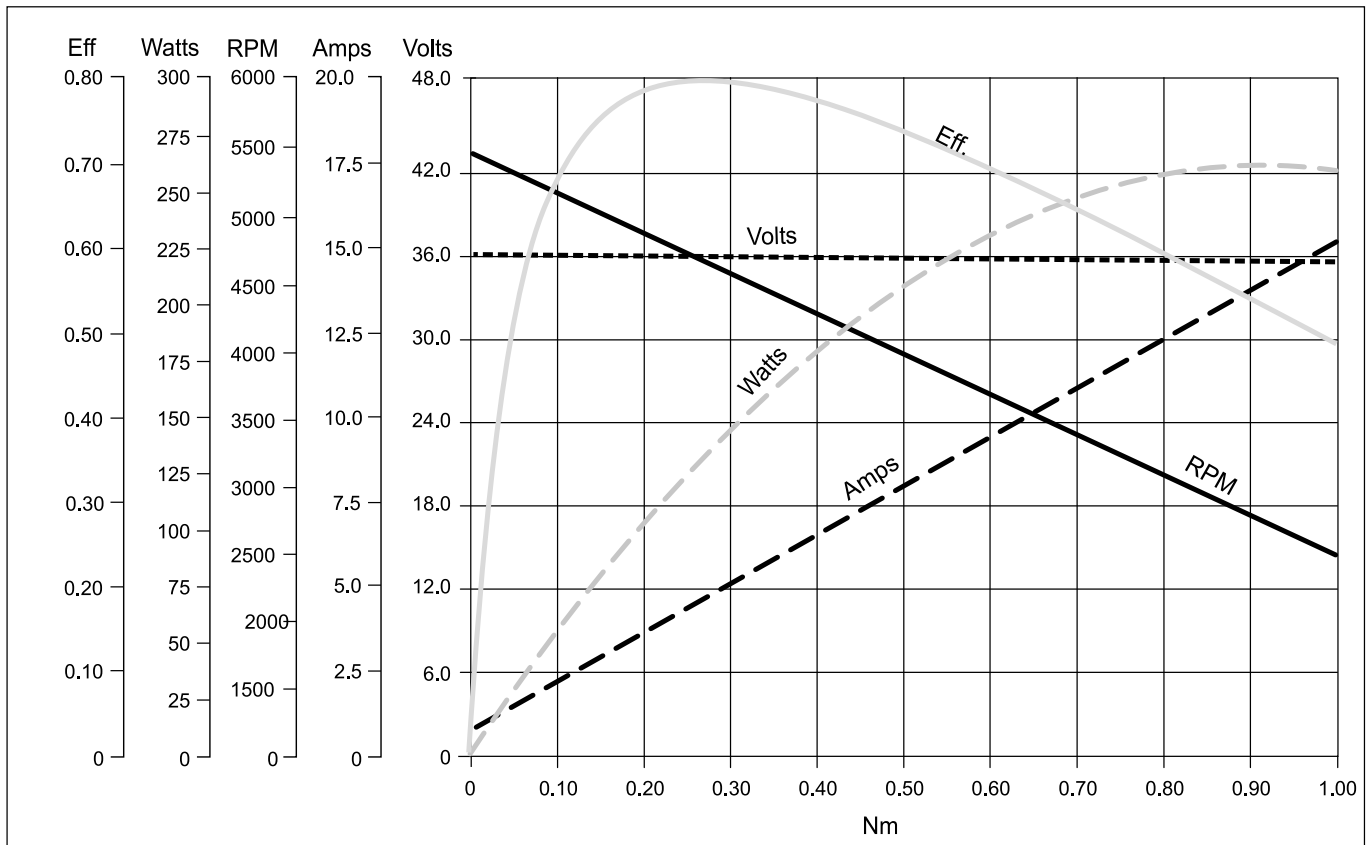

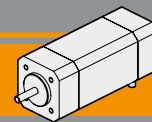

BL032.240 - BL032.240-IE

Dimensioni

Dimensions

BL032.240

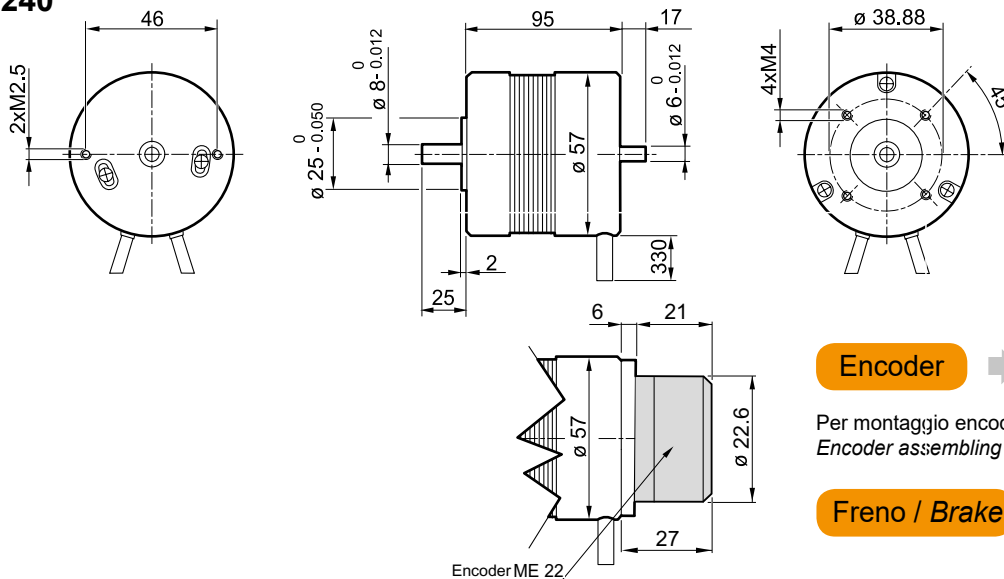

Encoder

I2

Per montaggio encoder serve flangia AS 4M.294
Encoder assembling needs flange AS 4M.294

Freno / Brake

E18

BL032.240-IE



Diagramma dei collegamenti

Connection diagram

BL032.240	
Cavi di potenza Power leads	Descrizione Description
Giallo / Yellow	Fase U / U motor Phase
Rosso / Red	Fase V / V motor Phase
Nero / Black	Fase W / W motor Phase

Cavi di segnale Signal leads	Descrizione Description
Blue	HALL fase U U phase HALL
Verde Green	HALL fase V V phase HALL
Bianco White	HALL fase W W phase HALL
Rosso (piccolo) Red (small)	Alimentazione HALL + 5Vcc Supply voltage for Hall sensors, + 5 Vdc
Nero (piccolo) Black (small)	Comune per i segnali di HALL Ground for HALL sensors

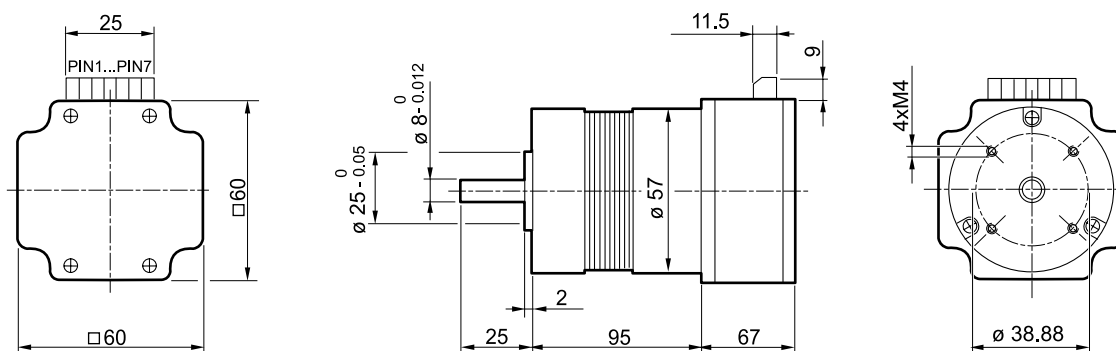
BL032.240-IE						
+5v	F/R	SV	PG	GND	-VP	+VP
1	2	3	4	5	6	7

7 +VP	Tensione positiva +24Vcc Power input +24VDC
6 -VP	Tensione negativa di alimentazione Power ground
5 GND	Riferimento comune per i segnali Common ground of system
4 PG	Impulsi per giro (12) Speed pulse output (TTL), 12 pulse/rev
3 SV	Potenziometro Speed voltage 0-5 VDC
2 F/R	Senso di marcia Rotating direction. Hi=CW
1 +5V	Tensione 5 Vcc in uscita +5V voltage output

Nota: Si raccomanda di seguire fedelmente gli schemi di collegamento qui riportati, pericolo di danneggiamento del motore o dell'elettronica.

Note: Pls, follow strictly the above connection diagrams, danger for the motor and the electric control

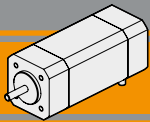

BL043.240 - BL043.240-IE

Specifiche costruttive

General features

Tipologia di avvolgimento <i>Winding type</i>	delta
Angolo sensori Hall <i>HALL effect angle</i>	120 gradi elettrici <i>120 degree electrical angle</i>
Gioco radiale <i>Radial play</i>	0.025 mm @ 460 g
Gioco assiale <i>End play</i>	0.025 mm @ 4000 g
Scentratura albero <i>Shaft run out</i>	0.025 mm

Max forza radiale <i>Max radial force</i>	75N @ 20 mm dalla flangia <i>75N @ 20 mm from flange</i>
Max forza assiale <i>Max axial force</i>	15N
Classe di isolamento termico <i>Insulation class</i>	Classe B <i>Class B</i>
Isolamento dielettrico <i>Dielectric strength</i>	500Vcc x 1 minuto <i>500 Vdc 1 minute</i>
Resistenza isolamento <i>Insulation resistance</i>	100MΩ minimo, 500Vcc <i>100MΩ min, 500 Vdc</i>

Modello <i>Model</i>	Poli <i>Poles</i>	Fasi <i>Phases</i>	Tensione nominale	Velocità nominale	Coppia nominale	Potenza nominale	Coppia di picco	Corrente nominale	Corrente di picco	Resistenza fase-fase	Induttanza fase-fase	Costante di coppia	Costante FCEM	Inerzia rotore	Peso	IP
			<i>Rated voltage</i>	<i>Rated speed</i>	<i>Rated torque</i>	<i>Rated power</i>	<i>Peak torque</i>	<i>Rated current</i>	<i>Peak current</i>	<i>Line to line resistance</i>	<i>Line to line inductance</i>	<i>Torque constant</i>	<i>Back EMF</i>	<i>Rotor inertia</i>	<i>Weight</i>	
			[V]	[min ⁻¹]	[Nm]	[W]	[Nm]	[A]	[A]	[Ω]	[mH]	[Nm/A]	[V/kRPM]	[gcm ²]	[kg]	
BL043.240	4	3	36	4000	0.43	180	1.27	6.8	20.5	0.35	1.0	0.063	6.6	230	1.25	20
BL043.240-IE	4	3	36	4000	0.43	180	0.86	6.8	13.6	0.38	1.0	0.063	6.6	230	1.44	30
BL043.240	4	3	24	3000	0.43	130	1.27	6.8	20.5	0.35	1.0	0.063	6.6	230	1.25	20
BL043.240-IE	4	3	24	3000	0.43	130	0.86	6.8	13.6	0.38	1.0	0.063	6.6	230	1.44	30



Prestazioni

Performances

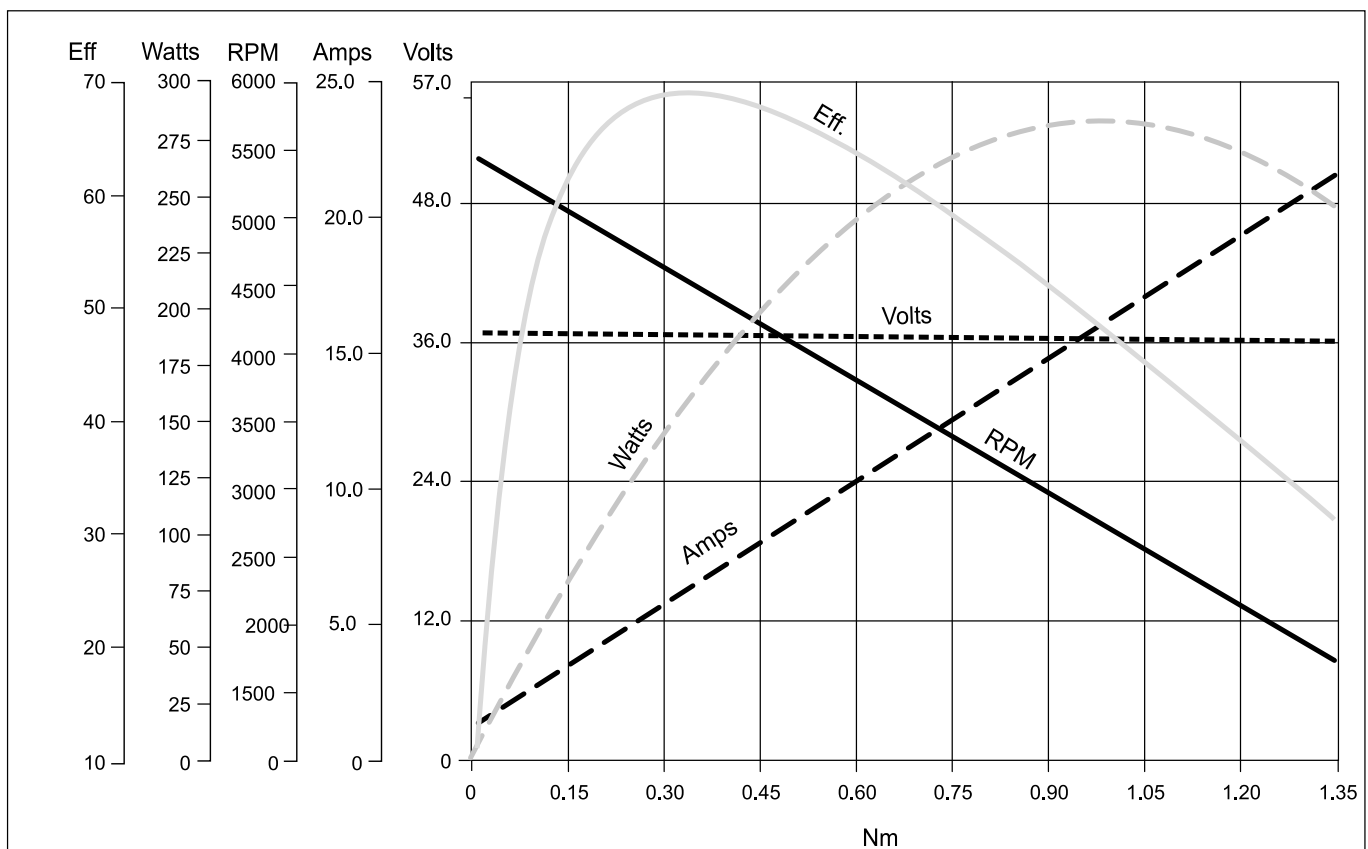

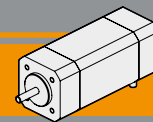

BL043.240 - BL043.240-IE

Dimensioni

Dimensions

BL043.240

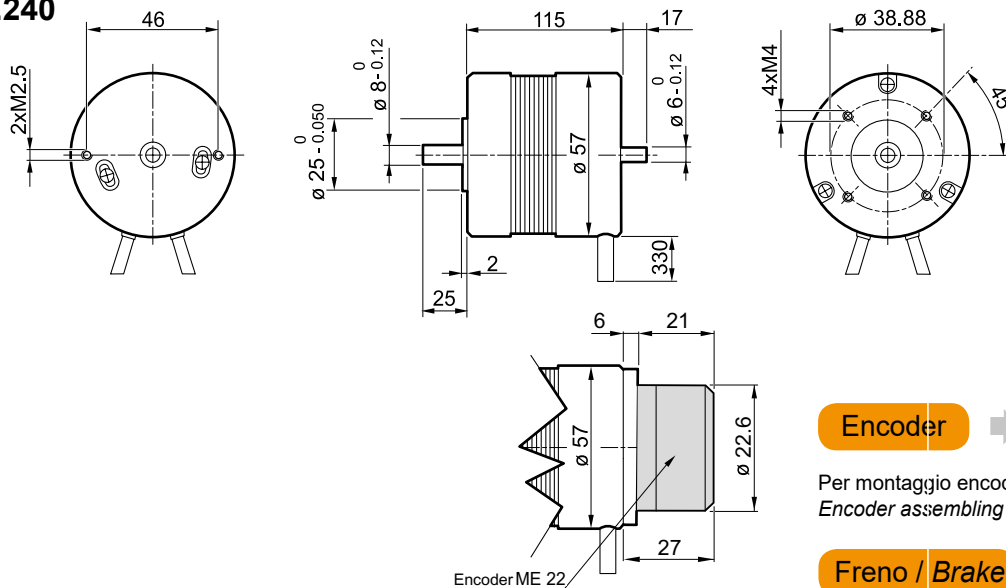

BL043.240-IE



Diagramma dei collegamenti

Connection diagram

BL043.240	
Cavi di potenza Power leads	Descrizione Description
Giallo / Yellow	Fase U / U motor Phase
Rosso / Red	Fase V / V motor Phase
Nero / Black	Fase W / W motor Phase

Cavi di segnale Signal leads	Descrizione Description
Blue	HALL fase U U phase HALL
Verde Green	HALL fase V V phase HALL
Bianco White	HALL fase W W phase HALL
Rosso (piccolo) Red (small)	Alimentazione HALL + 5Vcc Supply voltage for Hall sensors, + 5 Vdc
Nero (piccolo) Black (small)	Comune per i segnali di HALL Ground for HALL sensors

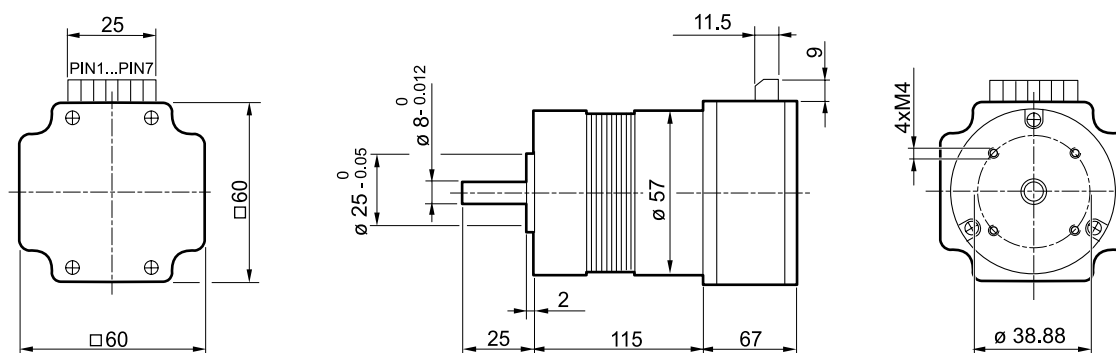
BL043.240-IE						
+5v	F/R	SV	PG	GND	-VP	+VP
1	2	3	4	5	6	7

7 +VP	Tensione positiva +24Vcc Power input +24VDC
6 -VP	Tensione negativa di alimentazione Power ground
5 GND	Riferimento comune per i segnali Common ground of system
4 PG	Impulsi per giro (12) Speed pulse output (TTL), 12 pulse/rev
3 SV	Potenzimetro Speed voltage 0-5 VDC
2 F/R	Senso di marcia Rotating direction. Hi=CW
1 +5V	Tensione 5 Vcc in uscita +5V voltage output

Nota: Si raccomanda di seguire fedelmente gli schemi di collegamento qui riportati, pericolo di danneggiamento del motore o dell'elettronica.

Note: Pls, follow strictly the above connection diagrams, danger for the motor and the electric control

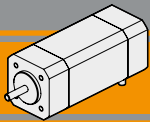

Motori brushless CC Brushless DC motors

BL070.48E

Specifiche costruttive

General features

Tipologia di avvolgimento <i>Winding type</i>	Stella <i>Star</i>	Max forza radiale <i>Max radial force</i>	220N @ 20 mm dalla flangia <i>220N @ 20 mm from flange</i>
Angolo sensori Hall <i>HALL effect angle</i>	120 gradi elettrici <i>120 degree electrical angle</i>	Max forza assiale <i>Max axial force</i>	60N
Gioco radiale <i>Radial play</i>	0.02 mm @ 450g	Classe di isolamento termico <i>Insulation class</i>	Classe B <i>Class B</i>
Gioco assiale <i>End play</i>	0.08 mm @ 450g	Isolamento dielettrico <i>Dielectric strength</i>	500Vcc x 1 minuto <i>500 Vdc 1 minute</i>
Scentratura albero <i>Shaft run out</i>	0.05 mm	Resistenza isolamento <i>Insulation resistance</i>	100MΩ minimo, 500Vcc <i>100MΩ min, 500 Vdc</i>

Modello <i>Model</i>	Poli <i>Poles</i>	Fasi <i>Phases</i>	Tensione nominale	Velocità nominale	Coppia nominale	Potenza nominale	Coppia di picco	Corrente nominale	Corrente di picco	Resistenza fase-fase	Induttanza fase-fase	Costante di coppia	Costante FCEM	Inerzia rotore	Peso	IP
			<i>Rated voltage</i>	<i>Rated speed</i>	<i>Rated torque</i>	<i>Rated power</i>	<i>Peak torque</i>	<i>Rated current</i>	<i>Peak current</i>	<i>Line to line resistance</i>	<i>Line to line inductance</i>	<i>Torque constant</i>	<i>Back EMF</i>	<i>Rotor inertia</i>	<i>Weight</i>	
			[V]	[min ⁻¹]	[Nm]	[W]	[Nm]	[A]	[A]	[Ω]	[mH]	[Nm/A]	[V/kRPM]	[gcm ²]	[kg]	
BL070.48E	8	3	48	3000	0.7	220	2.1	6.5	20	0.34	1.0	0.107	9	0.8	2.1	20

Azionamenti
Drives



Prestazioni

Performances

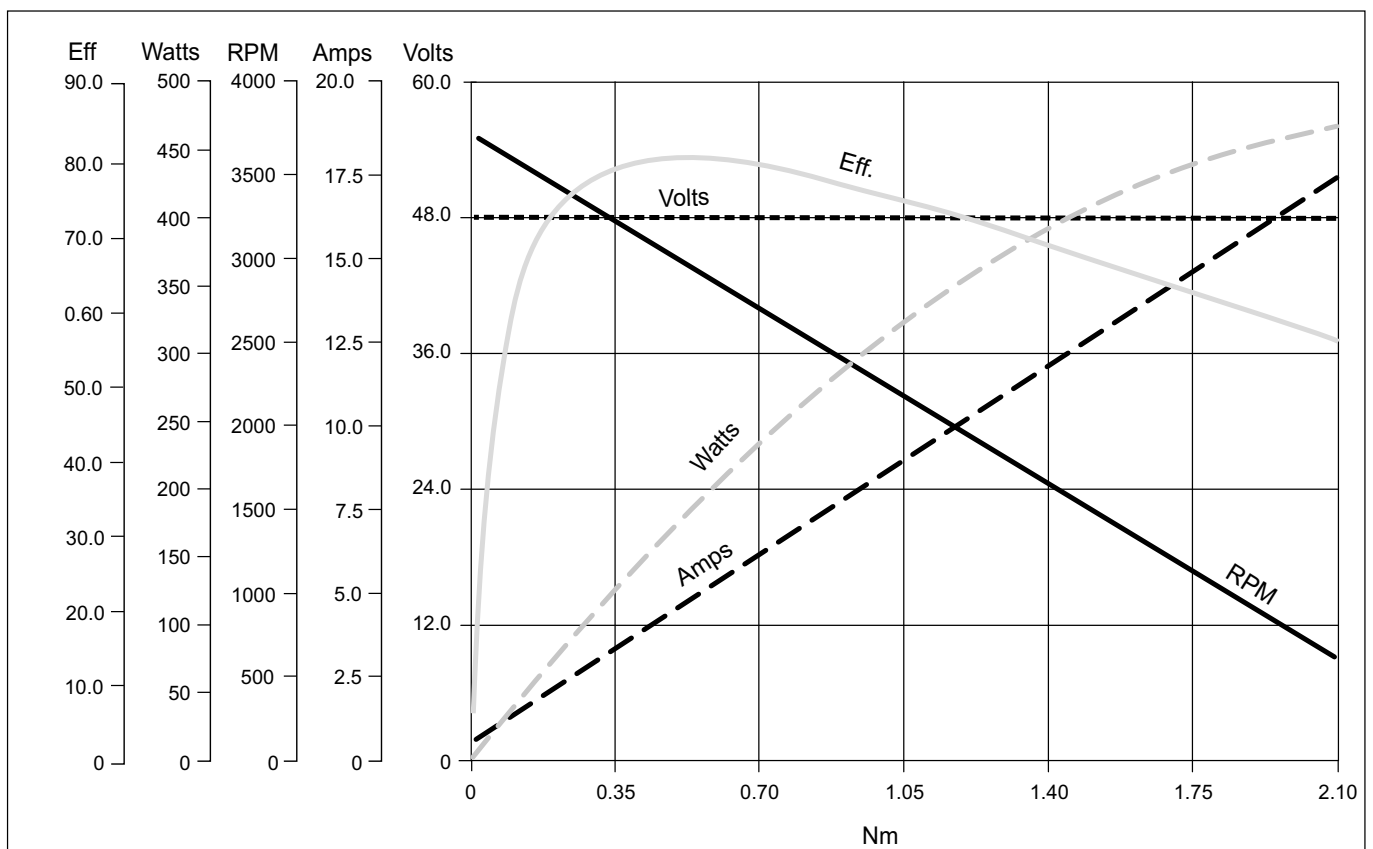

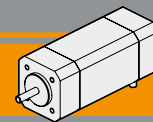

BL070.48E

Dimensioni

Dimensions

BL070.48E



Diagramma dei collegamenti

Connection diagram

Cavi di potenza Power leads	Descrizione Description
Blu / Blue	Fase U / U motor Phase
Marrone / Brown	Fase V / V motor Phase
Nero / Black	Fase W / W motor Phase

Cavi di segnale Signal leads	Descrizione Description
Blu Blue	HALL fase U U phase HALL
Verde Green	HALL fase V V phase HALL
Bianco White	HALL fase W W phase HALL
Rosso (piccolo) Red (small)	Alimentazione HALL + 5Vcc Supply voltage for Hall sensors, + 5 Vdc
Nero (piccolo) Black (small)	Comune per i segnali di HALL Ground for HALL sensors

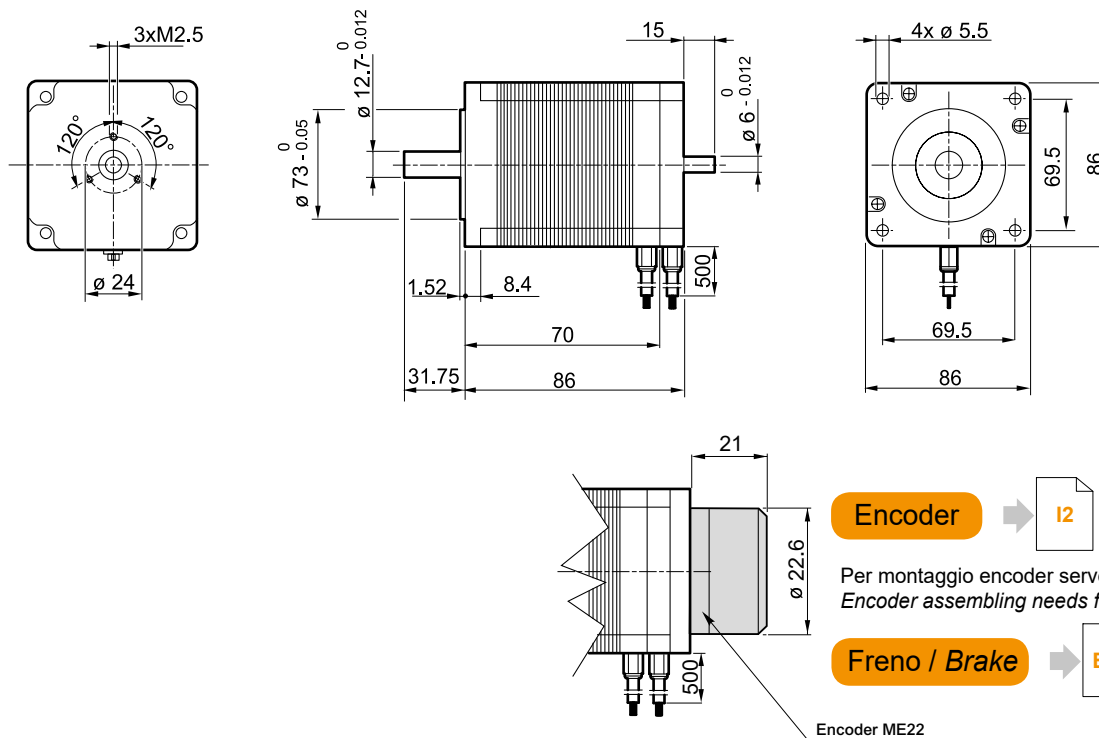
Nota: Si raccomanda di seguire fedelmente gli schemi di collegamento qui riportati, pericolo di danneggiamento del motore o dell'elettronica.

Note: Pls, follow strictly the above connection diagrams, danger for the motor and the electric control

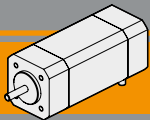

Freno

Brake

Freno / Brake

BL032...BR
BL043...BR

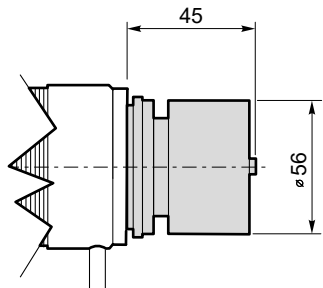

Freno con leva di sblocco/ Brake with hand release

BL032...BRL
BL043...BRL

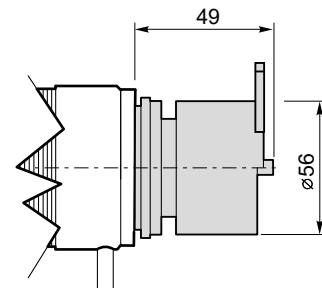
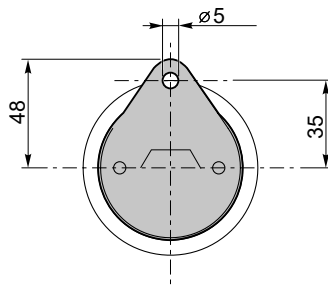

	P_n [W]	V [V]	M_n [Nm]	n₁ [min ⁻¹]
Caratteristiche del freno / Break features	14	12	2	3000
		24		

BL070...BR

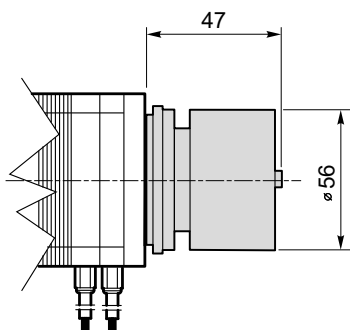

BL070...BRL

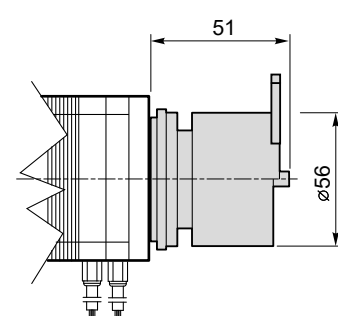
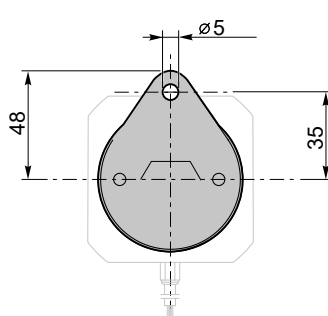

	P_n [W]	V [V]	M_n [Nm]	n₁ [min ⁻¹]
Caratteristiche del freno / Break features	14	12	2	3000
		24		

**INTECNO SRL**

Via Caduti di Sabbiuno, 9/E
 40011 Anzola dell'Emilia (BO) - ITALY
 Tel: +39 051 19985350
 Fax: +39 051 19985361
 info@intecno-srl.com
 www.intecno-srl.com



 **MA TRANSTECNO S.A.P.I. DE C.V.**
 Av. Mundial # 176, Parque Industrial
 JM Apodaca, Nuevo León,
 C.P. 66600 - MEXICO
 Tel: +52 8113340920
 info@transtecno.com.mx
 www.transtecno.com.mx

 **TRANSTECNO IBÉRICA**
THE MODULAR GEARMOTOR, S.A.
 C/Enginy, 2 Nave 6 - 08850 Gavà (Barcelona) - SPAIN
 Tel: +34 931 598 950
 info@transtecno.es
 www.transtecno.es

 **SALES OFFICE INDIA**
 A/10, Anagha, S.N. Road, Mulund (W) Mumbai
 400080 - INDIA
 Tel: +91 9820614698
 Fax - Italy: +39 051 734943
 indiaoffice@transtecno.com

 **TRANSTECNO U.S.A. LLC**
 5440 S.W. 156th Place Miami,
 FL 33185 - USA
 Tel: +1 (305) 220-4423
 Fax: +1 (305) 220-5945
 usaoffice@transtecno.com

 **TRANSTECNO B.V.**
 De Stuwdam, 43 - Ind. Terrein Wieken/Vinkenhoef
 3815 KM Amersfoort - NETHERLANDS
 Tel: +31(0) 33 45 19 505
 Fax: +31(0) 33 45 19 506
 info@transtecno.nl
 www.transtecno.nl

 **SALES OFFICE SOUTH KOREA**
 D-304 Songdo BRC Smart Valley 30, Songdomirae-ro,
 Yeonsu-gu, Incheon, 406-840 - KOREA
 Tel: +82 70 8288 2107
 Fax: +82 32 815 2107
 Mobile: +82 10 5094 2107
 koreaoffice@transtecno.com

 **SALES OFFICE BRAZIL**
 Rua Dr. Freire Alemão 155 / 402 - CEP. 90450-060
 Auxiliadora Porto Alegre RS - BRAZIL
 Tel: +55 51 3251 5447
 Fax: +55 51 3251 5447
 Mobile: +55 51 811 45 962
 braziloffice@transtecno.com
 www.transtecno.com.br

 **SALES OFFICE FRANCE**
 12 Impasse des Mûriers
 38300 Ruy - FRANCE
 Tel: +33 (0) 6 85 12 09 87
 Fax - Italy: +39 051 734943
 franceoffice@transtecno.com
 www.transtecno.fr

 **SALES OFFICE OCEANIA**
 44 Northview drive, Sunshine west 3020
 Victoria - AUSTRALIA
 Ph +61 03 9312 4722
 Fax +61 03 9312 4714
 Mobile: +61 0438060997
 oceaniaoffice@transtecno.com
 www.transtecno.com.au

INTECNO member of
TRANSTECNO
 group
 power transmissions

www.micro-intecno.com
 www.intecno-srl.com