



AS Series Module Manual

AS Series Module Manual

Revision History

Version	Revision	Date
1 st	The first version was published.	2016/11/30

AS Series Module Manual

Table of Contents

Chapter 1 Introduction

1.1	Overview	1-2
1.2	Specifications	1-3
1.2.1	General Specifications.....	1-3
1.2.2	EMS Standards	1-4
1.2.2.1	EMI	1-4
1.2.2.2	EMS	1-5
1.2.2.3	Conducted Immunity Test.....	1-5
1.3	Installation.....	1-6
1.3.1	Installing a Module.....	1-6
1.3.2	Installing a Removable Terminal Block	1-8
1.3.3	Changing a Module.....	1-9
1.3.4	Installing and Removing an Extension Card	1-9
1.3.5	Installing a Wiring Module.....	1-10

Chapter 2 Analog Input Module AS04AD

2.1	Overview	2-2
2.1.1	Characteristics.....	2-2
2.2	Specifications and Functions.....	2-2
2.2.1	Specifications	2-2
2.2.2	Profile.....	2-4
2.2.3	Arrangement of Terminals	2-5
2.2.4	Control Registers	2-6
2.2.5	Functions.....	2-10
2.2.6	Wiring	2-13
2.2.7	LED Indicators.....	2-15
2.3	HWCONFIG in ISPSOft.....	2-15
2.3.1	Initial Setting	2-15
2.3.2	Checking the Version of a Module.....	2-18
2.3.3	Online Mode.....	2-19
2.3.4	Importing/Exporting a Parameter File	2-20
2.3.5	Parameters.....	2-21

2.4	Troubleshooting	2-24
2.4.1	Error Codes.....	2-24
2.4.2	Troubleshooting Procedure	2-25

Chapter 3 Analog Output Module AS04DA

3.1	Overview	3-2
3.1.1	Characteristics.....	3-2
3.2	Specifications and Functions	3-2
3.2.1	Specifications	3-2
3.2.2	Profile.....	3-4
3.2.3	Arrangement of Terminals	3-5
3.2.4	Control Registers	3-5
3.2.5	Functions.....	3-7
3.2.6	Wiring	3-9
3.2.7	LED Indicators.....	3-11
3.3	HWCONFIG in ISPSOft	3-11
3.3.1	Initial Setting	3-11
3.3.2	Checking the Version of a Module.....	3-14
3.3.3	Online Mode.....	3-15
3.3.4	Importing/Exporting a Parameter File.....	3-16
3.3.5	Parameters	3-17
3.4	Troubleshooting	3-19
3.4.1	Error Codes.....	3-19
3.4.2	Troubleshooting Procedure	3-20

Chapter 4 Analog Input/Output Module AS06XA

4.1	Overview	4-2
4.1.1	Characteristics.....	4-2
4.2	Specifications and Functions	4-2
4.2.1	Specifications	4-2
4.2.2	Profile.....	4-5
4.2.3	Arrangement of Terminals	4-6
4.2.4	Control Registers	4-7
4.2.5	Functions	4-12
4.2.6	Wiring	4-18
4.2.7	LED Indicators.....	4-20
4.3	HWCONFIG in ISPSOft	4-21
4.3.1	Initial Setting	4-21

4.3.2	Checking the Version of a Module.....	4-24
4.3.3	Online Mode.....	4-25
4.3.4	Importing/Exporting a Parameter File	4-26
4.3.5	Parameters.....	4-27
4.4	Troubleshooting.....	4-31
4.4.1	Error Codes.....	4-31
4.4.2	Troubleshooting Procedure	4-32

Chapter 5 Temperature Measurement Module AS04RTD

5.1	Overview	5-2
5.1.1	Characteristics.....	5-2
5.1.2	Characteristics.....	5-2
5.2	Specifications and Functions.....	5-3
5.2.1	Specifications	5-3
5.2.2	Profile.....	5-4
5.2.3	Arrangement of Terminals.....	5-5
5.2.4	Control Registers	5-6
5.2.5	Functions.....	5-9
5.2.6	Control Mode.....	5-14
5.2.7	Wiring	5-18
5.2.8	LED Indicators.....	5-20
5.2	HWCONFIG in ISPSOft.....	5-21
5.3.1	Initial Setting.....	5-21
5.3.2	Checking the Version of a Module.....	5-24
5.3.3	Online Mode	5-25
5.3.4	Importing/Exporting a Parameter File	5-26
5.3.5	Parameters.....	5-27
5.4	Troubleshooting.....	5-30
5.4.1	Error Codes.....	5-30
5.4.2	Troubleshooting Procedure.....	5-31
5.4.3	State of the Conneciton	5-31

Chapter 6 Temperature Measurement Module AS04TC

6.1	Overview	6-2
6.1.1	Characteristics.....	6-3
6.2	Specifications and Functions.....	6-4

6.2.1	Specifications	6-4
6.2.2	Profile.....	6-5
6.2.3	Arrangement of Terminals.....	6-6
6.2.4	Control Registers	6-6
6.2.5	Functions	6-10
6.2.6	Control Mode.....	6-15
6.2.7	Wiring	6-19
6.2.8	LED Indicators.....	6-20
6.3	HWCONFIG in ISPSOft	6-21
6.3.1	Initial Setting	6-21
6.3.2	Checking the Version of a Module.....	6-24
6.3.3	Online Mode.....	6-25
6.3.4	Importing/Exporting a Parameter File.....	6-26
6.3.5	Parameters	6-27
6.4	Troubleshooting	6-30
6.4.1	Error Codes.....	6-30
6.4.2	Troubleshooting Procedure.....	6-31

Chapter 7 Load Cell Module AS02LC

7.1	Overview	7-2
7.2	Specifications	7-2
7.2.1	Specifications	7-2
7.2.2	Profile.....	7-3
7.2.3	Arrangement of Terminals.....	7-4
7.2.4	Control Registers	7-4
7.2.5	Functions.....	7-11
7.2.6	Wiring	7-16
7.3	Adjustment.....	7-18
7.3.1	Steps in adjusting points.....	7-18
7.3.2	Adjustment settings / LC Wizard.....	7-19
7.3.3	Adjustment settings / Instructional calibration.....	7-23
7.3.4	LED Indicators.....	7-26
7.4	HWCONFIG in ISPSOft	7-27
7.4.1	Initial Setting	7-27
7.4.2	Checking the Version of a Module.....	7-29

7.4.3	Online Mode	7-30
7.4.4	Importing/Exporting a Parameter File	7-31
7.4.5	Parameters	7-32
7.5	Troubleshooting.....	7-35
7.5.1	Error Codes	7-35
7.5.2	Troubleshooting Procedure	7-35

Chapter 8 Serial Communication Module AS00SCM

8.1	Introduction	8-2
8.2	Specification, Function and Wiring.....	8-2
8.2.1	The functional specifications	8-2
8.2.2	Dimensions and Profile	8-3
8.2.3	Wiring	8-4
8.2.3.1	AS00SCM Wiring	8-4
8.3	COM mode.....	8-6
8.3.1	Modbus.....	8-6
8.3.2	UD Link.....	8-6
8.3.2.1	TX Packets and RX Packets.....	8-6
8.3.2.2	Command	8-9
8.4	RTU Mode	8-10
8.5	Normal Exchange Area.....	8-12
8.6	Application.....	8-13
8.6.1	Modbus.....	8-13
8.6.1.1	Modbus Slave—Connection with Delta Products.....	8-14
8.6.1.2	Modbus Master—Connection with Delta Products.....	8-16
8.6.2	UD Link.....	8-23
8.7	Error Code	8-36
8.7.1	Troubleshooting for Module AS00SCM as a Communication Module	8-37
8.7.1.1	ERROR LED Indicator's Being ON.....	8-37
8.7.1.2	ERROR LED Indicator's Blinking Every 0.5 Seconds.....	8-37
8.7.2	Troubleshooting for Module AS00SCM as a Remote Module	8-38
8.7.2.1	Error LED Indicator's Being ON	8-38
8.7.2.2	ERROR LED Indicator's Blinking Every 0.5 Seconds.....	8-38
8.7.2.3	ERROR LED Indicator's Blinking Every 0.2 Seconds.....	8-39

Chapter 9 Function Cards

9.1	Introduction	9-2
9.2	Specification and Function.....	9-2
9.2.1	AS-F232	9-2
9.2.2	AS-F422	9-2
9.2.3	AS-F485	9-2
9.2.4	AS-F2AD.....	9-3
9.2.5	AS-F2DA.....	9-3
9.2.6	AS-FCOPM	9-4
9.3	Profiles and Dimensions	9-4
9.3.1	AS-F232	9-4
9.3.2	AS-F422/AS-F485/AS-F2AD/AS-F2DA.....	9-4
9.3.3	AS-FCOPM	9-5
9.4	Wiring.....	9-6
9.4.1	AS-F2AD.....	9-6
9.4.2	AS-F2DA.....	9-7
9.5	HWCONFIG in ISPSOft	9-7
9.5.1	Initial Setting	9-7

Chapter 1 Introduction

Table of Contents

1.1	Overview	1-2
1.2	Specifications	1-3
1.2.1	General Specifications	1-3
1.2.2	EMS Standards	1-4
1.2.2.1	EMI	1-4
1.2.2.2	EMS	1-5
1.2.2.3	Conducted Immunity Test	1-5
1.3	Installation	1-6
1.3.1	Installing a Module	1-6
1.3.2	Installing a Removable Terminal Block	1-8
1.3.3	Changing a Module	1-9
1.3.4	Installing and Removing an Extension Card	1-9
1.3.5	Installing a Wiring Module	1-10

1.1 Overview

This manual introduces the usage of special modules. Analog input/output modules, temperature measurement modules, load cell modules, and network modules are special modules. They are described below.

Classification	Model Name	Description
Analog input/output module	AS04AD-A	4-channel analog input module Hardware resolution: 16 bits 0~10V, 0/1~5V, -5~+5V, -10~+10V, 0/4~20mA, -20~+20mA Conversion time: 2ms/channel
	AS04DA-A	4-channel analog input module Hardware resolution: 12 bits -10~+10V, 0~20mA, 4~20mA Conversion time: 2ms/channel
	AS06XA-A	4-channel analog input module Hardware resolution: 16 bits 0~10V, 0/1~5V, -5~+5V, -10~+10V, 0/4~20mA, -20~+20mA Conversion time: 2 ms/channel 2-channel analog input module Hardware resolution: 12 bits -10~+10V, 0~20mA, 4~20mA Conversion time: 2ms/channel
Temperature measurement module	AS04RTD-A	4-channe, 2-wire/3-wire RTD Sensor type: Pt100 / Ni100 / Pt1000 / Ni1000 / JPt100 / LG-Ni1000 / Cu50 / Cu100 / 0~300Ω / 0~3000Ω input impedance Resolution: 0.1°C/0.1°F (16 bits) Conversion time: 200ms/channel
	AS04TC-A	4-channe thermocouple Sensor type: J, K, R, S, T, E, N, B and -100~+100 mV Resolution: 0.1°C/0.1°F (24 bits) Conversion time: 200ms/channel
Load cell module	AS02LC-A	2-channel, 4-wire/6-wire load cell sensor Eigenvalue applicable to a load cell: 1, 2, 4, 6, 20, 40, 80 mV/V

Classification	Model Name	Description
		Highest precision 1/10000 @ 50ms of the conversion time ADC Resolution : 24 bits Conversion time: 2.5 ~ 400ms (9 options to choose from)
Network module	AS00SCM-A	Serial communication module, 2x communication ports, applicable to communication cards, supporting MODBUS protocols
Remote I/O module	AS00SCM-A + AS-FCOPM	Applicable to AS-FCOPM function cards
Function cards	AS-F232	Serial communication port, RS232, functioning as a master or slave
	AS-F422	Serial communication port, RS422, functioning as a master or slave
	AS-F485	Serial communication port, RS485, functioning as a master or slave
	AS-FCOPM	CANopen communication port, supporting DS301, AS series remote modules and Delta servo systems
	AS-F2AD	2-channel analog input 0~10V (12 bits), 4~20mA (11 bits) Conversion time: 3ms/channel
	AS-F2DA	2-channel analog input 0~10V, 4~20mA (12 bits) Conversion time: 2ms/channel

1.2 Specifications

1.2.1 General Specifications

Item	Specifications
Operating temperature	-20~60°C
Storage temperature	-40~80°C
Operating humidity	5~95% No condensation
Storage humidity	5~95% No condensation
Work environment	No corrosive gas exists.

1

Item	Specifications
Installation location	In a control box
Pollution degree	2
EMC (electromagnetic compatibility)	Refer to chapter 7 for more information.
Vibration resistance	Tested with: 5 Hz \leq f \leq 8.4 Hz, constant amplitude 3.5 mm; 8.4 Hz \leq f \leq 150 Hz, constant acceleration 1g Duration of oscillation: 10 sweep cycles per axis on each direction of the 3 mutually perpendicular axes International Standard IEC 61131-2 & IEC 60068-2-6 (TEST Fc)
Shock resistance	Tested with: Half-sine wave: Strength of shock 15 g peak value, 11 ms duration; Shock direction: The shocks in each in direction per axis, on 3 mutually perpendicular axes (total of 18 shocks) International Standard IEC 61131-2 & IEC 60068-2-27 (TEST Ea)
Safety	Conforms to IEC 61131-2, UL508

1.2.2 EMS Standards

1.2.2.1 EMI

Port	Frequency range	Level (Normative)	Reference standard
Enclosure port (radiated) (measured at a distance of 10 meters)	30-230 MHz	40 dB (μ V/m) quasi-peak	IEC 61000-6-4
	230-1000 MHz	47 dB (μ V/m) quasi-peak	
AC power port (conducted)	0.15-0.5 MHz	79 dB (μ V) quasi-peak	
		66 dB (μ V) average	
	0.5-30 MHz	73 dB (μ V) quasi-peak	
		60 dB (μ V) average	

1.2.2.2 EMS

Environmental phenomenon	Reference standard	Test		Test level
Electrostatic discharge	IEC 61000-4-2	Contact		±4 kV
		Air		±8 kV
Radio frequency electromagnetic field Amplitude modulated	IEC 61000-4-3	80% AM, 1 kHz sinusoidal	2.0-2.7 GHz	1 V/m
			1.4-2.0 GHz	3 V/m
			80-1000 MHz	10 V/m
Power frequency magnetic field	IEC 61000-4-8	60 Hz		30 A/m
		50 Hz		30 A/m

1.2.2.3 Conducted Immunity Test

Environmental phenomenon		Fast transient burst	High energy surge	Radio frequency interference
Reference standard		IEC 61000-4-4	IEC 61000-4-5	IEC 61000-4-6
Interface/Port	Specific interface/port	Test level	Test level	Test level
Data communication	Shielded cable	1 kV	1 kV CM	10 V
	Unshielded cable	1 kV	1 kV CM	10 V
Digital and analog I/O	AC I/O (unshielded)	2 kV	2 kV CM 1 kV DM	10 V
	Analog or DC I/O(unshielded)	1 kV	1 kV CM	10 V
	All shielded lines (to the earth)	1 kV	1 kV CM	10 V
Equipment power	AC power	2 kV	2 kV CM 1 kV DM	10 V
	DC power	2 kV	0.5 kV CM 0.5 kV DM	10 V
I/O power and auxiliary power	AC I/O and AC auxiliary power	2 kV	2 kV CM 1 kV DM	10 V

Environmental phenomenon		Fast transient burst	High energy surge	Radio frequency interference
Reference standard		IEC 61000-4-4	IEC 61000-4-5	IEC 61000-4-6
Interface/Port	Specific interface/port	Test level	Test level	Test level
output	DC I/O and DC auxiliary power	2 kV	0.5 kV CM 0.5 kV DM	10 V

1.3 Installation

1.3.1 Installing a Module

1. Please install the PLC onto the power supply module, and then insert the module hooks into the DIN rail mounting slot.
2. Link the I/O modules on the right side of the PLC and make sure they are hooked together, push the modules into the DIN rail until hearing a click. That means the module is on the DIN rail and is connected to the PLC as illustrated below.

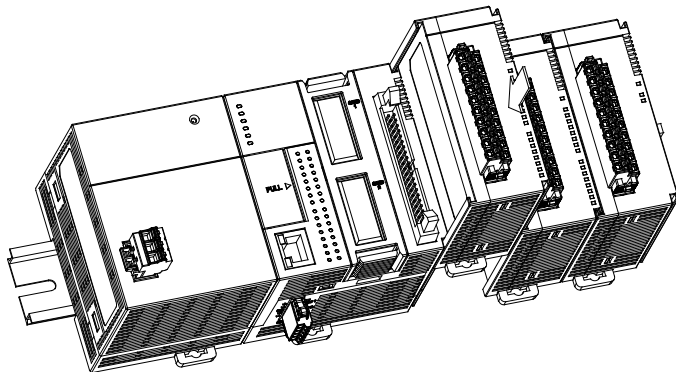

3. When the installation is done, secure the module with screws.

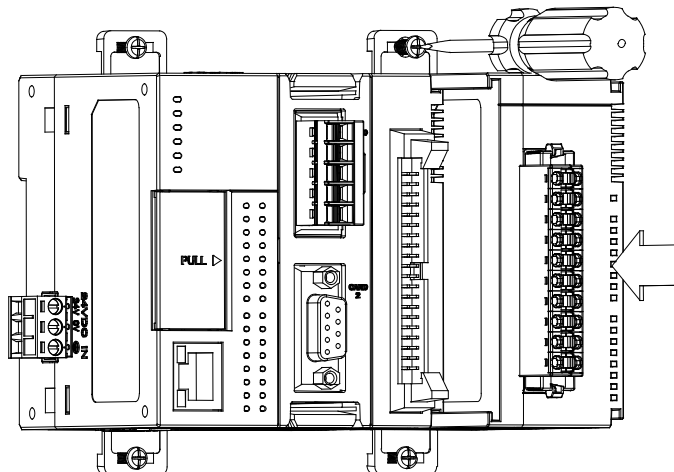

4. If there is a vibration source in the installation site, it is suggested to installed anti-vibration baffles on the sides of the AS series for better stabilization as the gray baffles illustrated below.

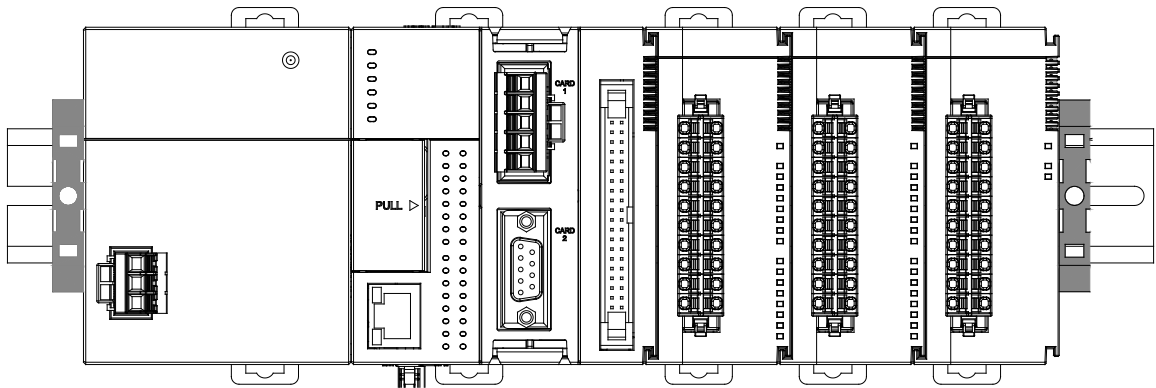

- **Install the baffles:**

1. Hook the baffles onto the DIN rail and press it down as the directional arrow indicated below.

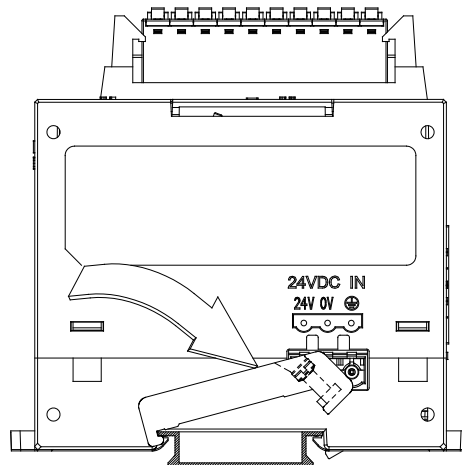

2. Use screws to secure the baffle.

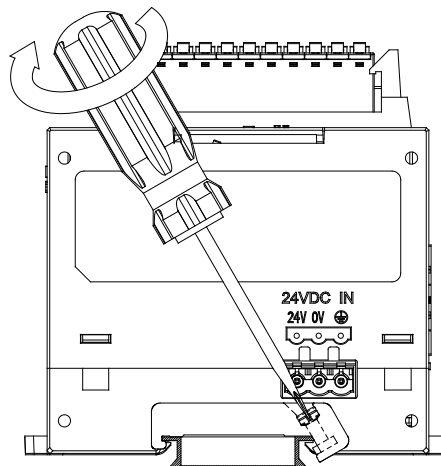

3. The baffles installation is complete as the image shown below.

1

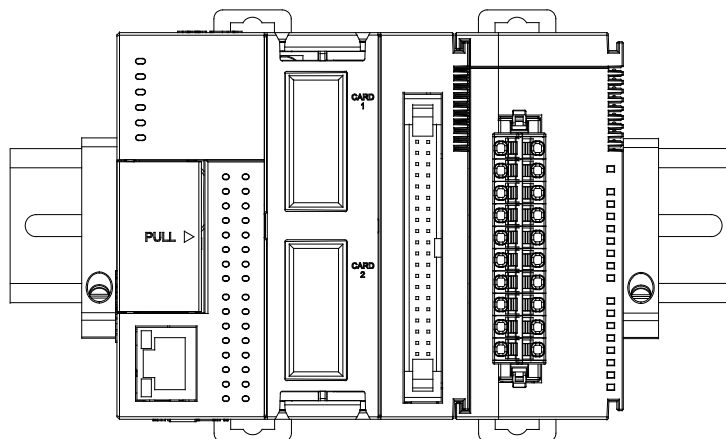

1.3.2 Installing a Removable Terminal Block

Please install the removable terminal block on the module, as illustrated below.

● Installation

1. Level the terminal block at the printed circuit board, and press it into the module.

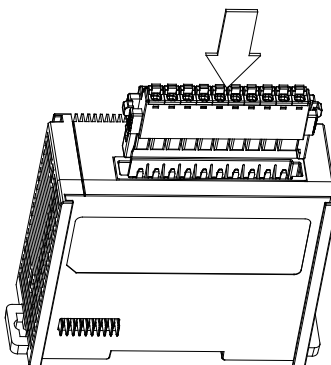

● Removal

1. Pull down the clip in the direction indicated by the arrow and then pull the terminal block up as illustrated below.

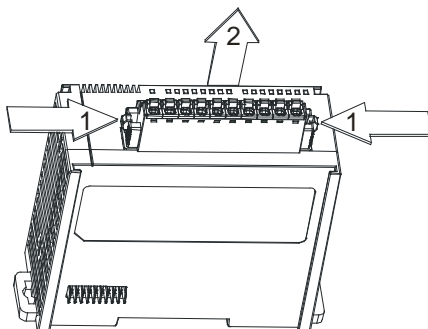

1.3.3 Changing a Module

1. Take the removable terminal block out of the module and pull the clip out from the DIN rail as the image show below.

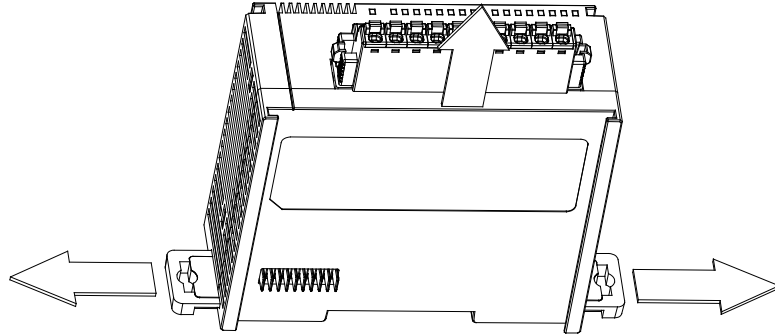

2. Remove the module to be changed out.
3. Slide the new module in as the image shown below.

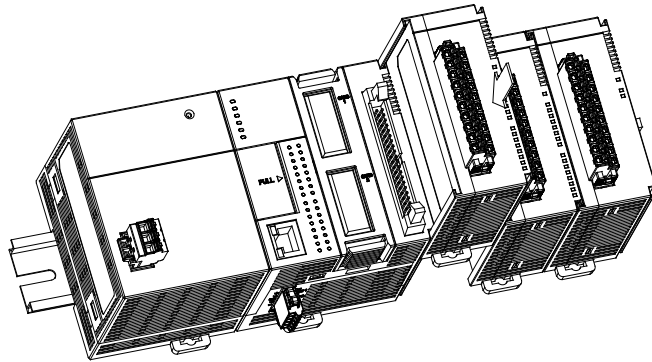

1.3.4 Installing and Removing an Extension Card

● Installation

Put the extension card into the extension card slot until hearing a click.

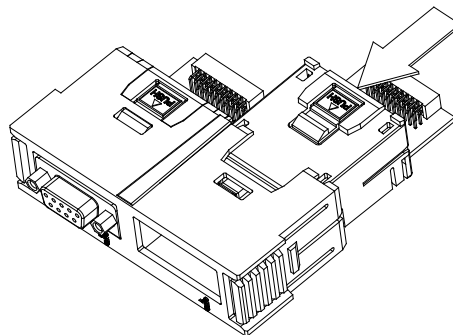

● Removal

Press the  to release the extension card and then take the extension card out.

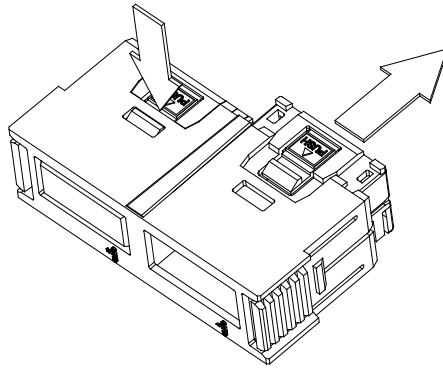

1.3.5 Installing a Wiring Module

Put a communication cable in the port on a CPU module, and make sure that the connector of the cable is joined to the port properly.

● Installation

1. One side of a wiring module has to be fixed first.
2. Press the driver board in the direction indicated by arrow 1, and make sure that the groove is combined with the DIN rail.

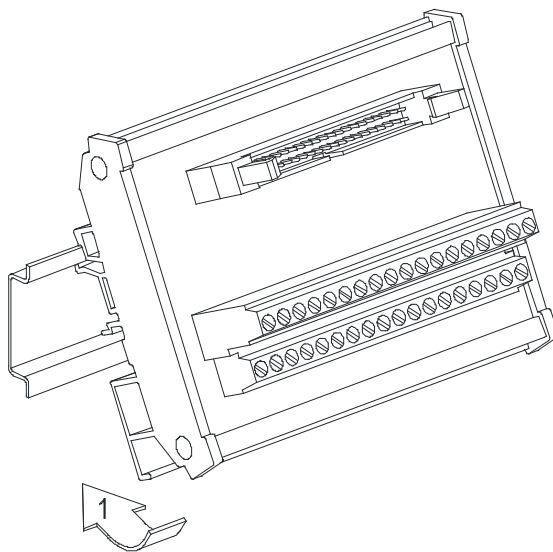

● **Removal**

1. Push the wiring module in the direction indicated by arrow 1.
2. Pull the wiring module in the direction indicated by arrow 2.

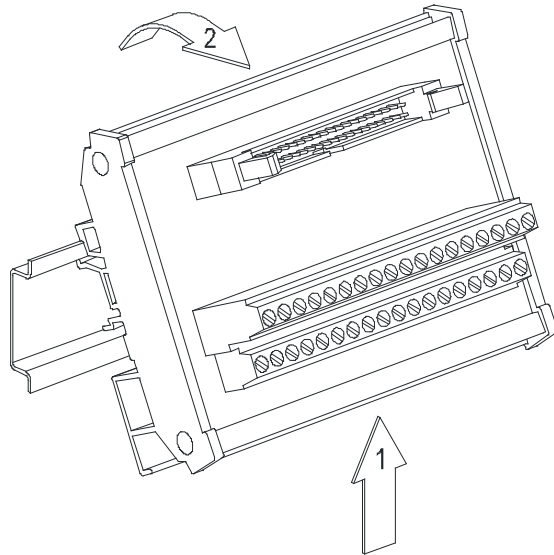

MEMO

1

Chapter 2 Analog Input Module AS04AD

Table of Contents

2.1 Overview	2-2
2.1.1 Characteristics.....	2-2
2.2 Specifications and Functions	2-2
2.2.1 Specifications	2-2
2.2.2 Profile.....	2-4
2.2.3 Arrangement of Terminals	2-5
2.2.4 Control Registers	2-6
2.2.5 Functions.....	2-10
2.2.6 Wiring	2-13
2.2.7 LED Indicators.....	2-15
2.3 HWCONFIG in ISPSOft	2-15
2.3.1 Initial Setting	2-15
2.3.2 Checking the Version of a Module.....	2-18
2.3.3 Online Mode.....	2-19
2.3.4 Importing/Exporting a Parameter File	2-20
2.3.5 Parameters	2-21
2.4 Troubleshooting	2-24
2.4.1 Error Codes.....	2-24
2.4.2 Troubleshooting Procedure	2-25

2.1 Overview

The specifications for analog-to-digital modules, the operation, and the programming are described in this chapter. A/D module will be refer to AS04AD-A the analog-to-digital module in this chapter.

2.1.1 Characteristics

- (1) **A module is selected according to practical application.**

AS04AD-A: There are four channels. Inputs received by a channel can be either voltages or currents.

- (2) **High-speed conversion**

An analog signal is converted into a digital signal at a speed of 25 ms a channel.

- (3) **High accuracy**

Conversion accuracy: The error is $\pm 0.2\%$ of an input voltage, and $\pm 0.2\%$ of an input current. (The ambient temperature is 25°C. The number of input voltages/currents which are averaged is 100.)

- (4) **A module can be set by means of utility software.**

HWCONFIG is built-in utility software in ISPSOft. Users can set modes and parameters in HWCONFIG to complete hardware configuration without spending time writing a program to set registers corresponding to functions.

2.2 Specifications and Functions

2.2.1 Specifications

- **Electrical specifications**

Module name	AS04AD-A
Number of inputs	4
Analog-to-digital conversion	Voltage input/Current input
Supply voltage	24 VDC (20.4 VDC~28.8 VDC) (-15%~+20%)
Connector type	Removable terminal block
Conversion time	2ms/channel
Isolation	An analog circuit is isolated from a digital circuit by a digital integrated circuit/an optocoupler, but the analog channels are not isolated from one another. Isolation between a digital circuit and a ground: 500 VDC

	Isolation between an analog circuit and a ground: 500 VDC Isolation between an analog circuit and a digital circuit: 500 VDC Isolation between the 24 VDC and a ground: 500 VDC
--	---

- **Functional specifications**

Analog-to-digital conversion	Voltage input				
Rated input range	-10 V~10 V	0 V~10 V	±5 V	0 V~5 V	1 V~5 V
Hardware input range	-10.1 V~10.1 V	-0.1 V~10.1 V	-5.05 V~5.05 V	-0.05 V~5.05 V	0.95 V~5.05 V
Fiducial error (Room temperature)	±0.2%				
Fiducial error (Full temperature range)	±0.5%				
Linearity error (Room temperature)	±0.02%				
Linearity error (Full temperature range)	±0.06%				
Hardware resolution	16 bits				
Input impedance	2MΩ				
Absolute input range	±15 V				

Analog-to-digital conversion	Current input		
Rated input range	±20 mA	0 mA~20 mA	4 mA~20 mA
Hardware input range	-20.2 mA~20.2 mA	-0.2 mA~20.2 mA	3.8 mA~20.2 mA
Fiducial error (Room temperature)	±0.2%		
Fiducial error (Full temperature range)	±0.5%		
Linearity error (Room temperature)	±0.04%		

Analog-to-digital conversion	Current input
(Full temperature range)	
Linearity error	±0.10%
Hardware resolution	16 bits
Input impedance	250 Ω
Absolute input range	±32 mA

2.2.2 Profile

- AS04AD-A

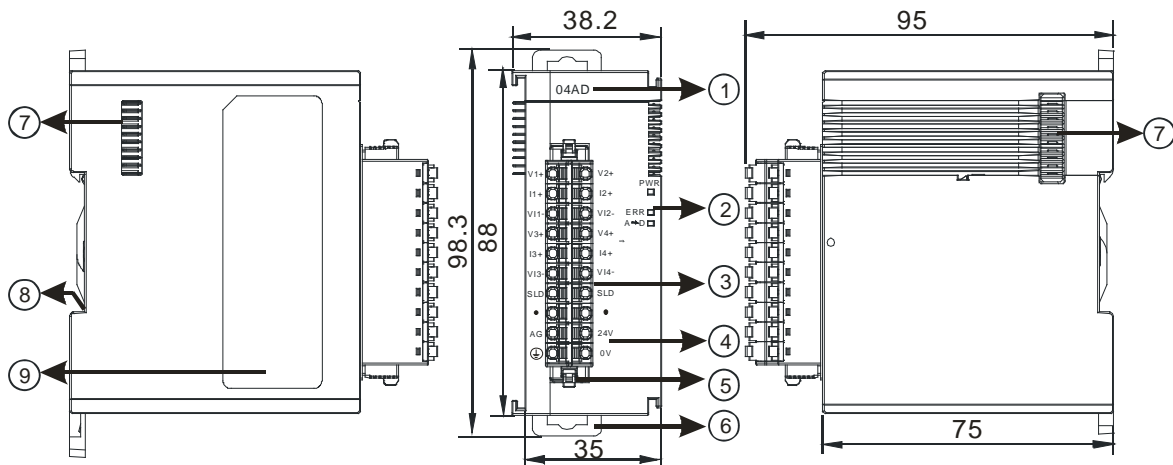

Unit: mm

Number	Name	Description
1	Model name	Model name of the module
2	POWER LED indicator	Indicating the status of the power supply ON: the power is on OFF: no power
	ERROR LED indicator	Error status of the module ON: A serious error occurs in the module. OFF: The module is normal. Blinking: A slight error occurs in the module.
	Analog to digital conversion indicator	Indicating the analog to digital conversion status Blinking: conversion is taking place OFF: stop conversion

Number	Name	Description
3	Removable terminal block	The inputs are connected to sensors. The outputs are connected to loads which will be driven.
4	Arrangement of the input/output terminals	Arrangement of the terminals
5	Terminal block clip	Removing the terminal block
6	DIN rail clip	Securing the module onto the DIN rail
7	Module connecting set	Connecting the modules
8	Ground clip	
9	Label	Nameplate

2.2.3 Arrangement of Terminals

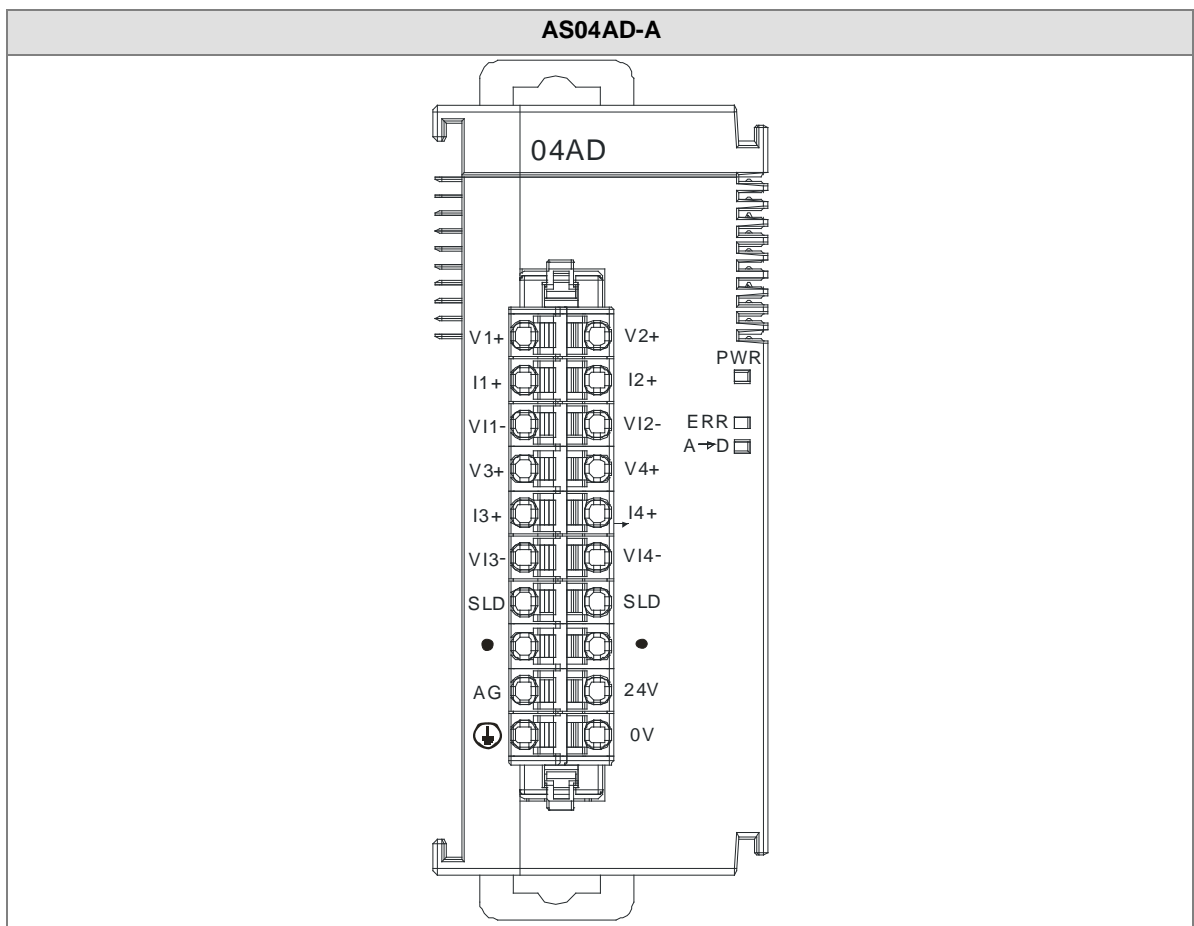

2.2.4 Control Registers

CR#	Name	Description	Defaults
0	Format setup	0: integer format 1: floating point format	0
1	Channel 1 mode setup	0: closed 1: -10V~10V	1
2	Channel 2 mode setup	2: 0~10V 3: -5~5V	
3	Channel 3 mode setup	4: 0~5V 5: 1~5V	
4	Channel 4 mode setup	6: 0mA~20mA 7: 4mA~20mA 8: -20mA~20mA	
5	Channel 1 offset	Setting range: -32768~32767	0
6	Channel 2 offset		
7	Channel 3 offset		
8	Channel 4 offset		
9	Channel 1 gain	Setting range: -32768~32767	1000
10	Channel 2 gain		
11	Channel 3 gain		
12	Channel 4 gain		
13	Channel 1 average times	Setting range: 1~100	10
14	Channel 2 average times		
15	Channel 3 average times		
16	Channel 4 average times		
17	Channel 1 filter average percentage	Setting range: 0~3, unit: $\pm 10\%$	1
18	Channel 2 filter average percentage		
19	Channel 3 filter average percentage		
20	Channel 4 filter average		

CR#	Name	Description	Defaults
	percentage		
21	Channel sampling cycle (sampling/integration time)	0 : 2ms 1 : 4ms 2 : 10ms 3 : 15ms 4 : 20ms 5 : 30ms 6 : 40ms 7 : 50ms 8 : 60ms 9 : 70ms 10 : 80ms 11 : 90ms 12 : 100ms	0
22	Channel alarm setup	0: open channel alarm 1: close channel alarm bit0: Channel 1 bit1: Channel 2 bit2: Channel 3 bit3: Channel 4 0: warning 1: alarm bit8: Error occurs in the module power bit9: Error occurs in the module hardware bit10: Error occurs in calibration	0
23	The minimum scale range	The analog input mode of a channel has a corresponding digital range; that is, an analog range corresponds to a digital range. For example, if the analog range is -10 V~10 V and the digital range is -10.0~10.0, the analog values -10 V~10 V correspond to the digital values -10.0~10.0. If the analog input mode of	-10
24	for channel 1		
25	The minimum scale range		-10
26	for channel 2		
27	The minimum scale range		-10
28	for channel 3		

CR#	Name	Description	Defaults				
29	The minimum scale range for channel 4	a channel is 4mA~20mA, it means the minumium scale range is 4mA and the maximum scale range is 20mA. When the format is interger format, the scale range is invalid.	-10				
30							
31	The maximum scale range for channel 1			10			
32							
33	The maximum scale range for channel 2				10		
34							
35	The maximum scale range for channel 3					10	
36							
37	The maximum scale range for channel 4						10
38							
201	Instruction set	Instructions for peak values 16#0101: record the peark value again for channel 1 16#0102: record the peark value again for channel 2 16#0104: record the peark value again for channel 3 16#0108: record the peark value again for channel 4 16#010F: record the peark value again for channel 1~4 16#0201: enable to record for channel 1 16#0202: enable to record for channel 2 16#0204: enable to record for channel 3 16#0208: enable to record for channel 4 16#020F: enable to record for channels 1~4 16#0211: disable to record for channel 1 16#0212: disable to record for channel 2 16#0214: disable to record for channel 3 16#0218: disable to record for channel 4 16#021F: disable to record for channel 1~4 16#0502: restore to its default settings					0
210	The maximum peak value for channel 1	Interger format; the maximum peak value for analog inputs					0
211	The maximum peak value for channel 2		0				
212	The maximum peak value for channel 3		0				

CR#	Name	Description	Defaults
213	The maximum peak value for channel 4		0
214	The minimum peak value for channel 1	Interger format; the minimum peak value for analog inputs	0
215	The minimum peak value for channel 2		0
216	The minimum peak value for channel 3		0
217	The minimum peak value for channel 4		0
222	The time to record for chanel 1		Unit: 10ms, setting range 1~100 Setting the time to record the digital value for the channels
223	The time to record for chanel 2	1	
224	The time to record for chanel 3	1	
225	The time to record for chanel 4	1	
240	The number of records for channel 1	Range: 0~500, display the current records	
241	The number of records for channel 2		0
242	The number of records for channel 3		0
243	The number of records for channel 4		0
4000~4499	Records for channel 1		500 records for channel 1
4500~4999	Records for channel 2	500 records for channel 2	--
5000~5499	Records for channel 3	500 records for channel 3	--
5500~5999	Records for channel 4	500 records for channel 4	--

2.2.5 Functions

Item	Function	Description
1	Enabling/Disabling a channel	1. Users can enable or disable a channel. 2. If a channel is disabled, the total conversion time is decreased.
2	Calibration	Users can calibrate a linear curve.
3	Average	Conversion values are averaged and filtered.
4	Disconnection detection	Only if the analog rang is 4 mA~20 mA or 1 V~5 V does the disconnection detection function.
5	Channel detec and alarm	If an input signal exceeds a range of inputs which can be received by hardware, the module will give an alarm or a warning. This function can be disabled.
6	The limit detections for channels	Saving the maximum/minimum values for channles
7	Records for channales	Saving the analog curves for channels
8	Scale range	When the format is floating-point numbers, the scale range can be set.

1. Enabling/Disabling a channel

An analog signal is converted into a digital signal at a speed of 2ms a channel. The total conversion time is 2ms X (the number of channels). If a channel is not used, users can disable it to decrease the total conversion time.

2. Calibration

- To make a curve meet actual needs, users can calibrate the curve by changing an offset and a gain. A calibration range depends on a range of inputs which can be received by hardware. The formula is as below.

$$Output = \frac{(Input \times Gain)}{1000} + Offset$$

Example:

The inputs received by a channel are voltages in the range of -10.0 V to +10.0 V. The gain is 1000, and the offset is 0. The corresponding value for the original signal -10.0 V to +10.0 V is -32000~32000. When using the offset -100, the calibrated vaule for the original signal -10.0 V to +10.0 V is -31900~32100.

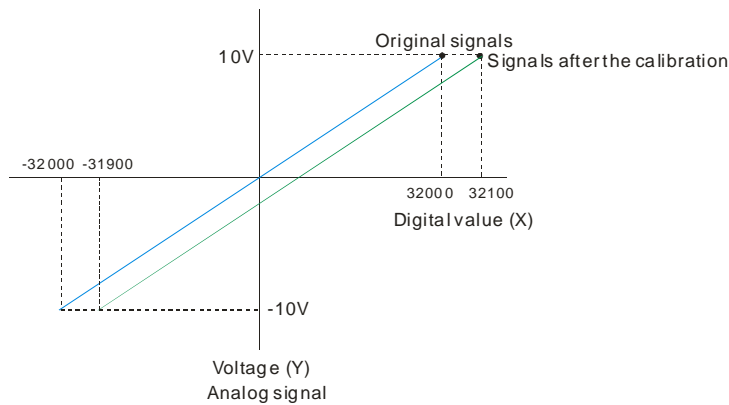

3. Average

The average value can be set in the range of 1~100. It is a steady value obtained from the sum of the read values. However, due to unavoidable external factors, the read values may be an acute pulse, resulting in fierce changes in the average value. The filtering function thus exclude the read value that is an acute pulse from the sum-up and equalization, so the average value obtained will not be affected by the acute read value. The filter percentage is set in the range of 0~3, and the unit is 10%. Setting 0 in the filter range, the system will sum up all the read values and equalize to obtain the average value; setting 1 in the filter range, the system will exclude the 10% of the maximum and minimum value and then equalize to obtain the average value.

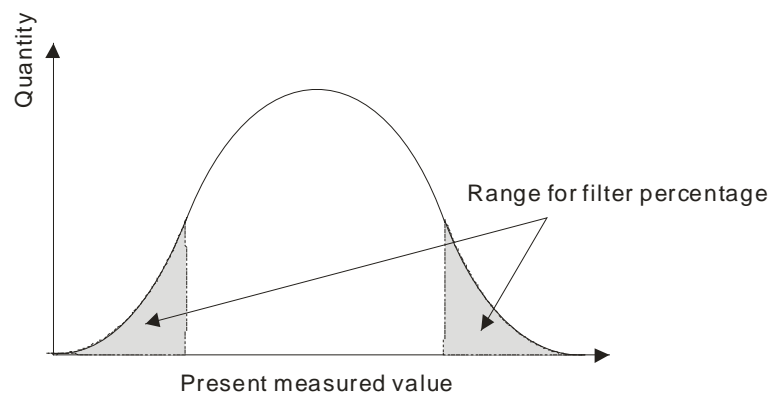

4. Disconnection detection

Only if the analog rang is 4 mA~20 mA or 1 V~5 V does the disconnection detection function. If a module which can receive inputs ranging from 4 mA to 20 mA or from 1 V to 5V is disconnected, an input signal will exceed the range of inputs which can be received by the hardware, and the module will give an alarm or a warning.

5. Channel detection

If an input signal exceeds a range of inputs which can be received by hardware, an error message appears.

This function can be disabled and then the module will not send an alarm or warning when the input signal exceeding the range of inputs.

6. The limit detections for channels

Saving the maximum/minimum values for channels and users can know the peak to peak value from the maximum/minimum values

2

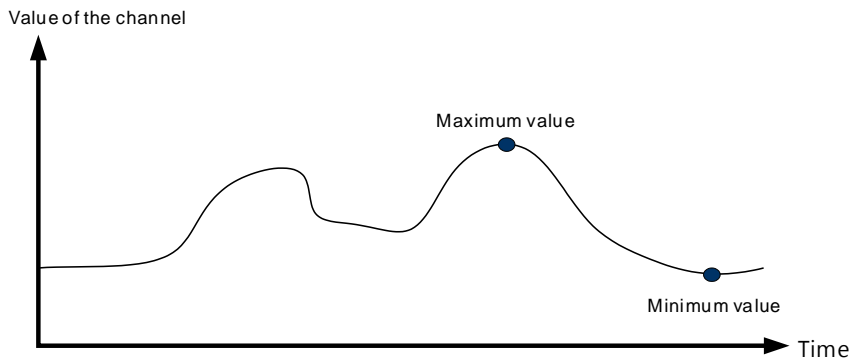

7. Records for channels

Record the input value of the cyclic sampling for each channel, up to 500 pieces can be recorded and the recording time is 10ms.

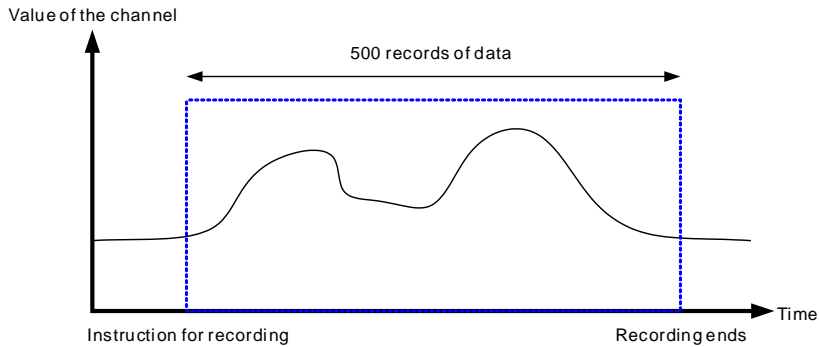

8. Scale range

When the format is floating-point numbers, the scale range can be set. The analog output mode of a channel has a corresponding digital range. Digital values correspond to analog outputs sent by a module. For example, if the analog range is -10 V~10 V, the digital range is -10.0~10.0 and the scale HSP is 10.0 and the scal LSP is -10.0. The digital values -10.0~10.0 correspond to the analog values -10 V~10 V as the example shown below.

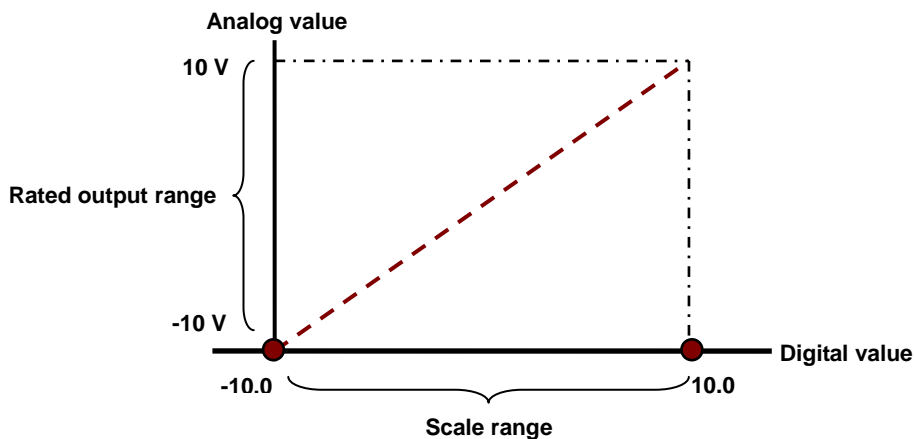

2.2.6 Wiring

● Precautions

In order to make the functions of an analog-to-digital module perfect and ensure the reliability of a system at the same time, external wiring which prevents noise is necessary. Before installing cables, users need to follow the precautions below.

- (1) To prevent a surge and induction, an AC cable and input signal cables which are connected to AS04AD must be separate cables.
- (2) A cable must not be installed near a main circuit, a high-voltage cable, or a cable connected to a load which is not a PLC. Besides, a cable must not be bound to a main circuit, a high-voltage cable, or a cable connected to a load which is not a PLC. Otherwise, effects that noise, induction, and a surge have will increase.
- (3) Please connect a shielded cable and a hermetically sealed cable with the ground separately.
- (4) Terminals with insulation sleeves can not be arranged as a terminal block. It is recommended that the terminals be covered with insulation tubes.
- (5) Please use single-core cables or twin-core cables in a diameter of 24 AWG~22 AWG and with less than 1mm pin-typed connectors. Only use copper conducting wires with a temperature of 60/75°C.

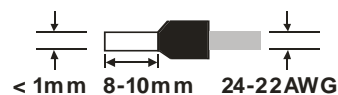

- (6) Two-wire connection/Three-wire connection/Four-wire connection:

- Two-wire connection/Three-wire connection (Passive transducer): A transducer and an analog input module are connected to a power circuit collectively.
- Four-wire connection (Active transducer): A transducer uses an independent power supply. It is

not connected to the power circuit which is connected to an analog input module.

● External wiring

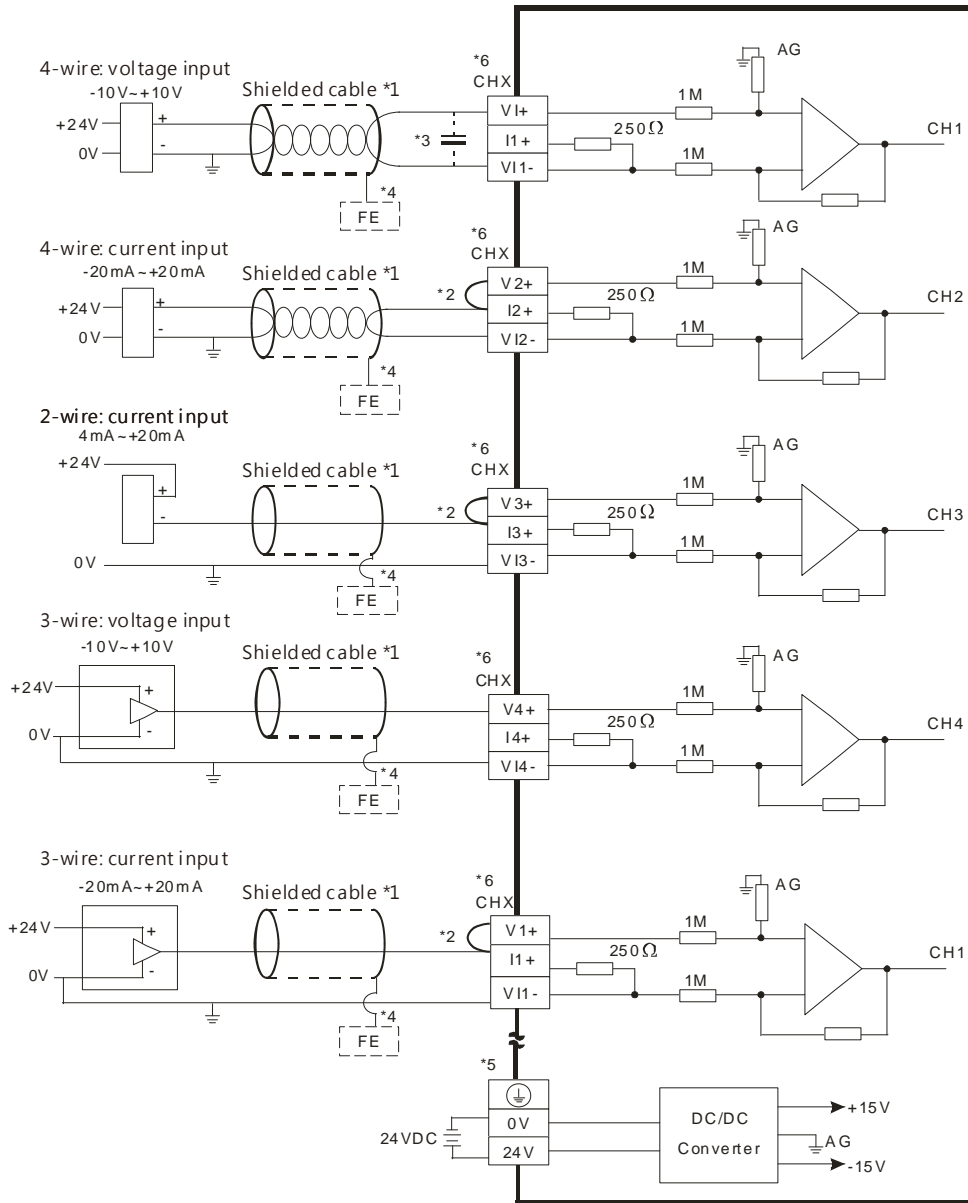

- *1. Please use shielded cables to isolate the analog input signal cable from other power cables.
- *2. If the module is connected to a current signal, the terminals Vn and In+ (n=1~4) must be short-circuited.
- *3. If the ripple in the input voltage results in the noise interference with the wiring, please connect the module to the capacitor having a capacitance in the range of 0.1 μF to 0.47 μF with a working voltage of 25 V.
- *4. Please connect the shielded cable to the terminal FE.
- *5. Please connect the terminal \oplus to the ground terminal.
- *6. Every channel can work with the wiring presented above.

2.2.7 LED Indicators

Number	Name	Description
1	RUN LED indicator	Operating status of the module ON: The module is running. OFF: The module stops running.
2	ERROR LED indicator	Error status of the module ON: A serious error occurs in the module. OFF: The module is normal. Blink: A slight error occurs in the module.
3	Analog to digital conversion indicator	Indicating the analog to digital conversion status Blinking: conversion is taking place OFF: stop conversion

2.3 HWCONFIG in ISPSoft

2.3.1 Initial Setting

- (1) Start ISPSoft, and then double-click **HWCONFIG**.

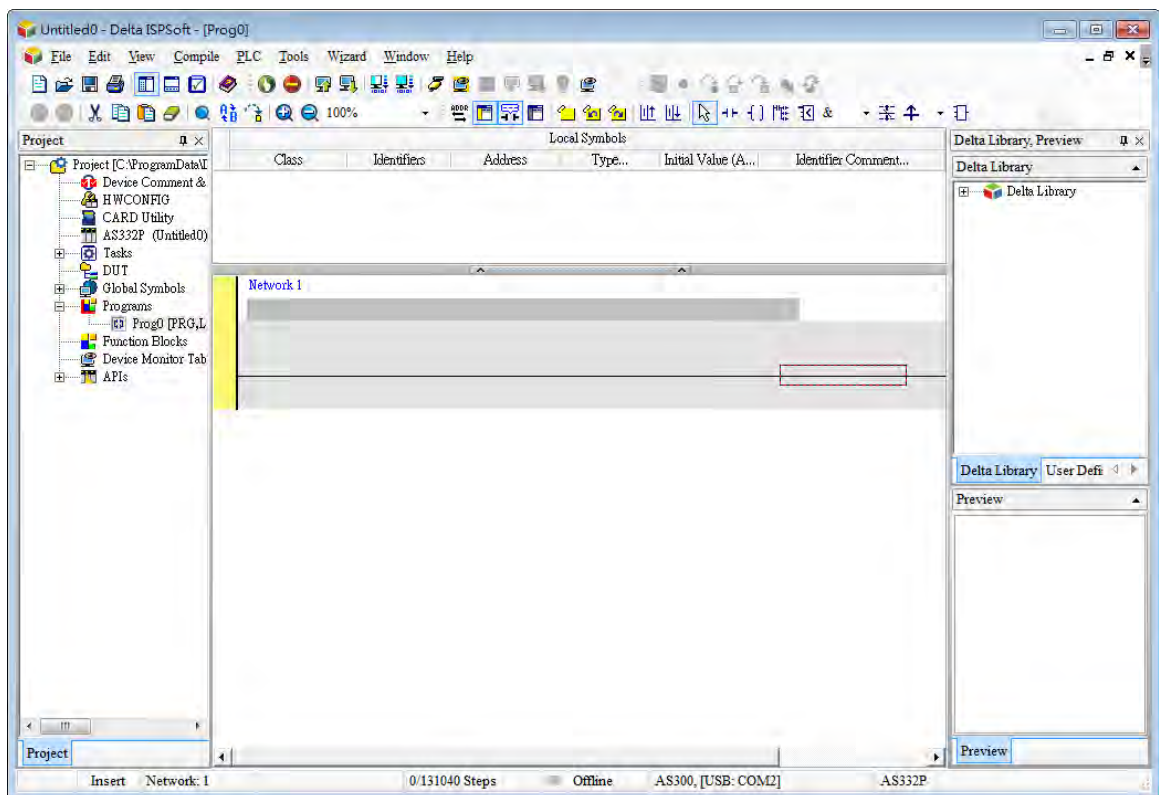

(2) Selecting a module.

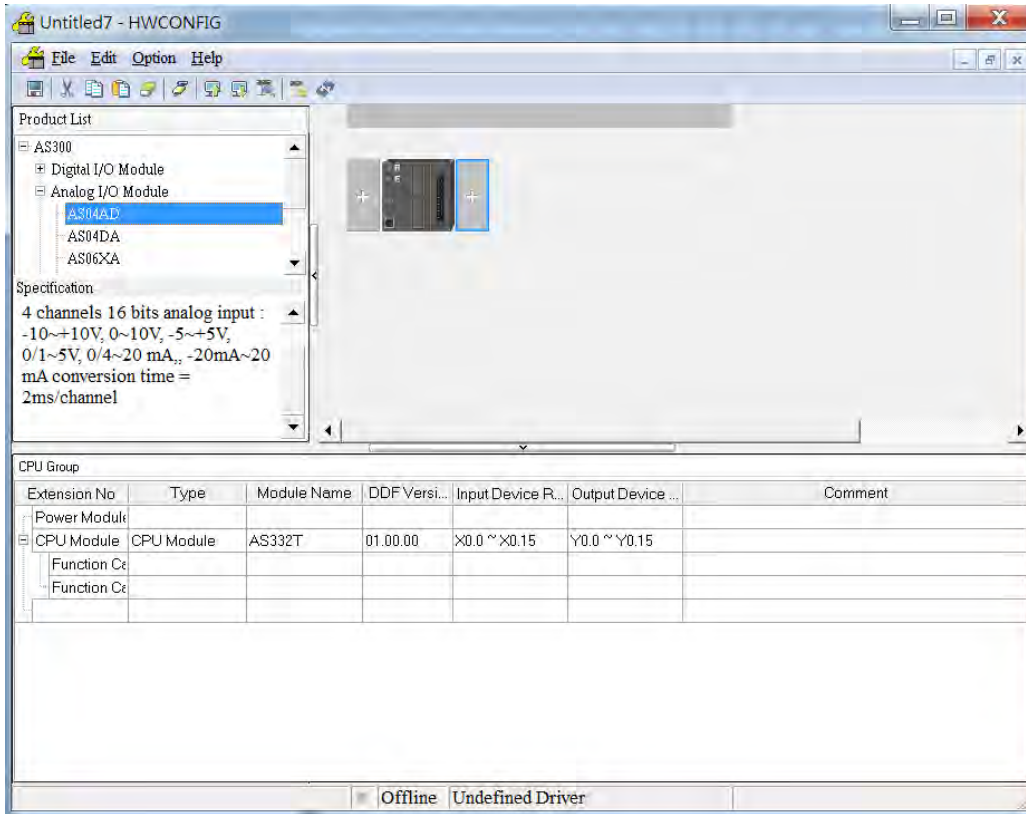

(3) Double-click the module to open the Device Setting page.

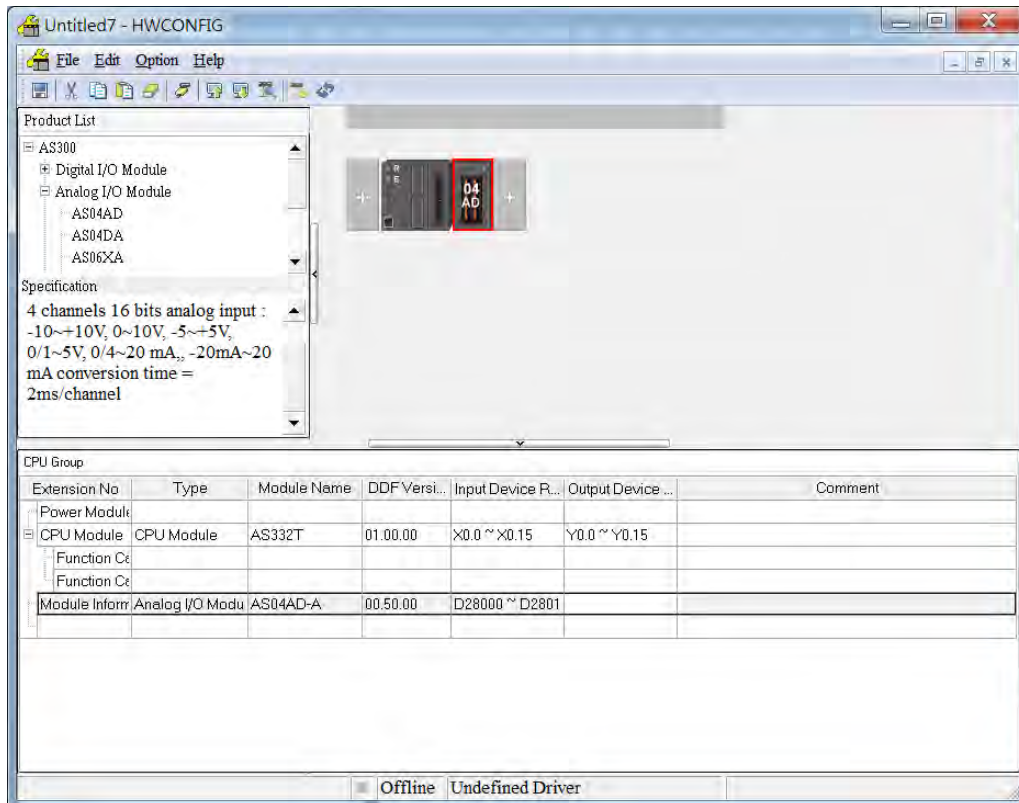

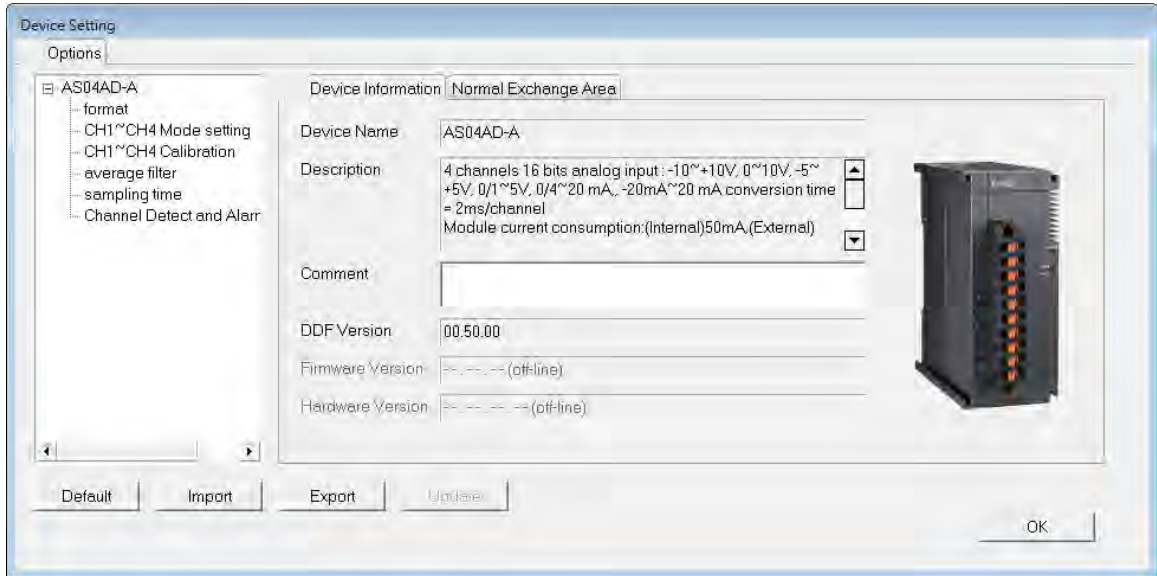

(4) Set the parameters, and then click **OK**.

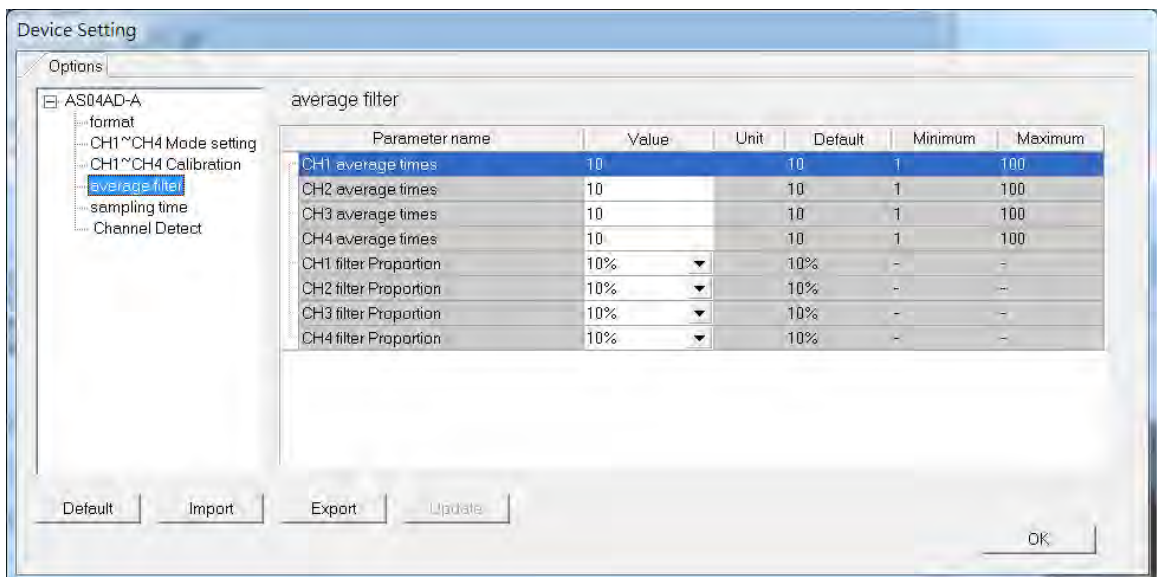

- (5) Click **Download** on the toolbar to download the parameters. (The parameters can not be downloaded when the CPU module runs.)

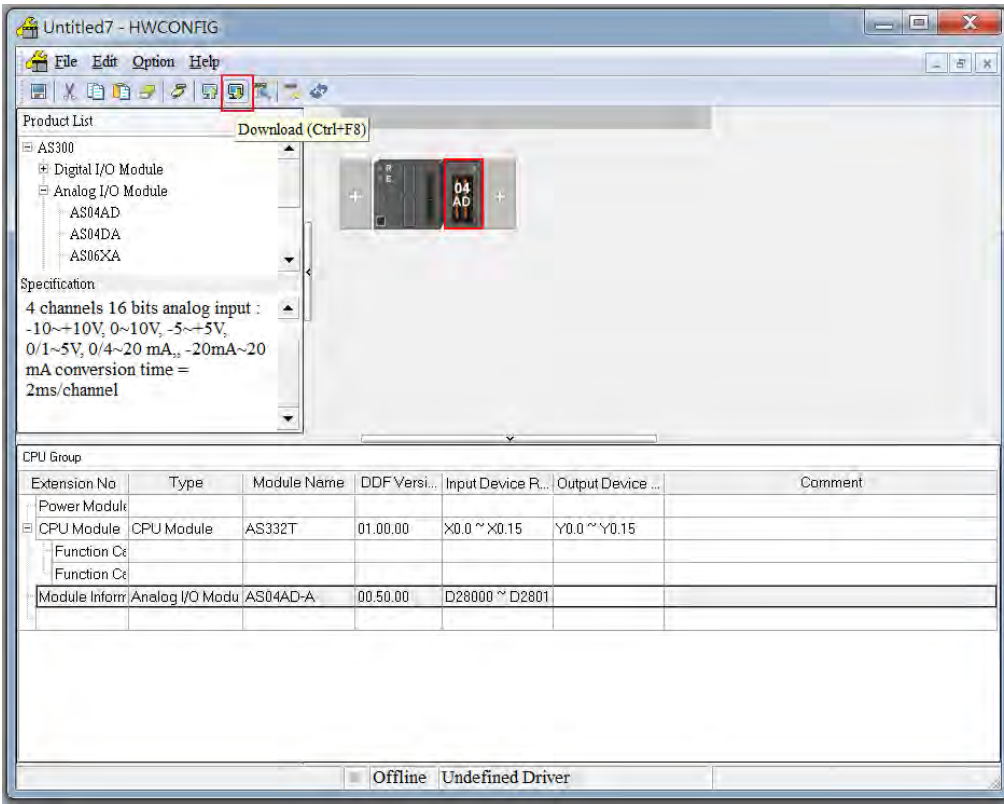

2.3.2 Checking the Version of a Module

- (1) **Online Mode.** On the **Option** menu, click **Online Mode**.

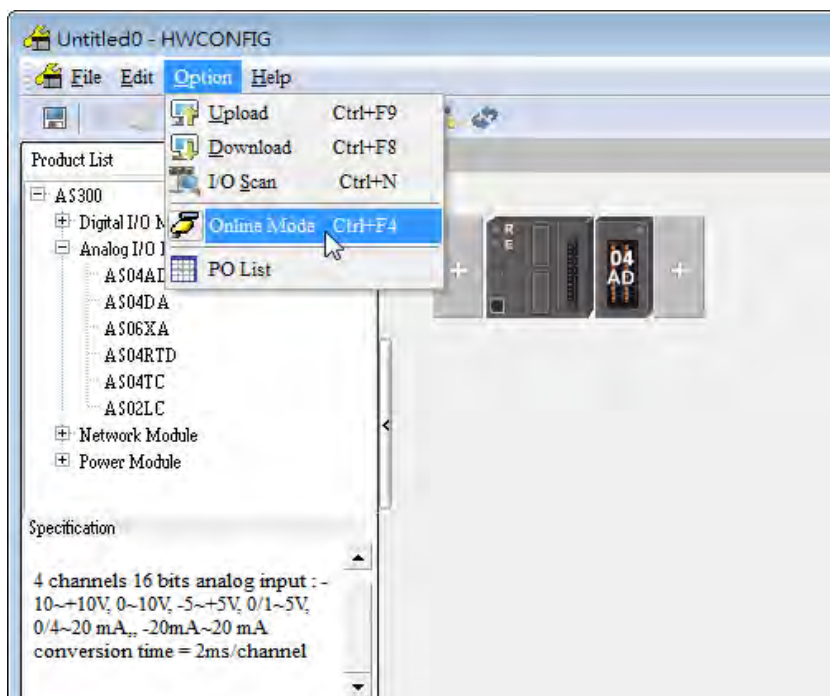

- (2) Double-click the module to see the Device Setting page. The version of the firmware and that of the hardware are displayed.

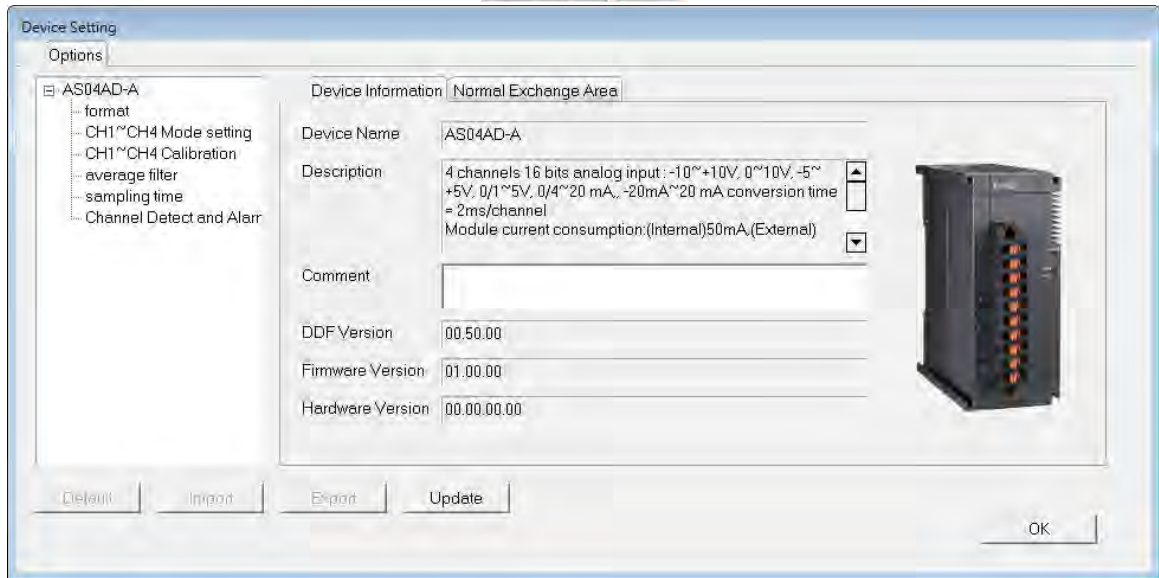

2.3.3 Online Mode

- (1) Click **Online Mode** on the toolbar.

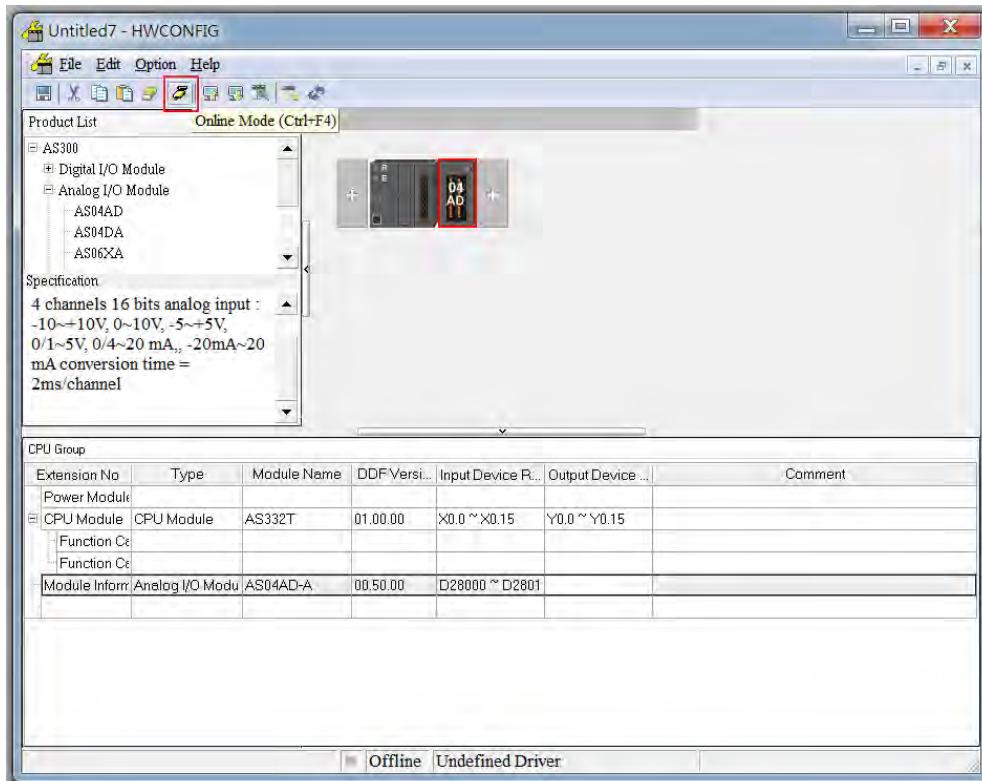

(2) Right-click the module.

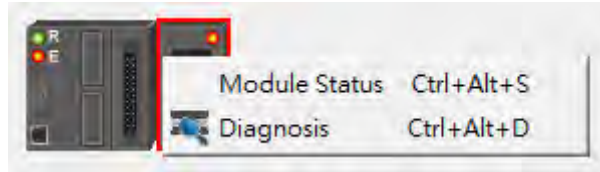

(3) The module status can be shown.

A screenshot of a window titled "AS04AD-A" showing a table of module status data. The table has three columns: "Channel", "Value (32 bits)", and "Data Type".

Channel	Value (32 bits)	Data Type
Error code	6145	DECIMAL
CH1 Input	0	DECIMAL
CH2 Input	0	DECIMAL
CH3 Input	0	DECIMAL
CH4 Input	0	DECIMAL

2.3.4 Importing/Exporting a Parameter File

(1) After **Export** is clicked, the parameters will be saved as a CSV file (.csv).

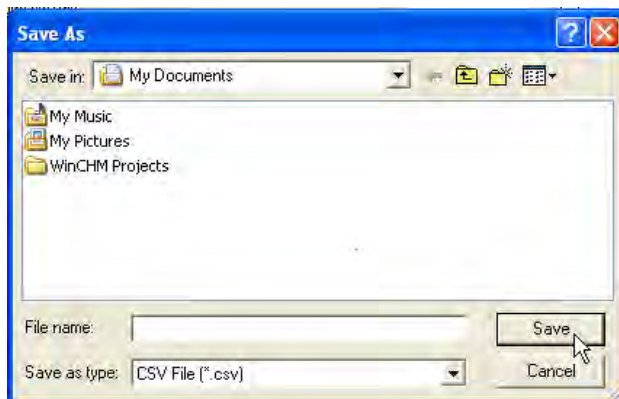
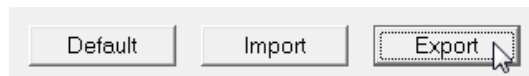



(2) Click **Import**, and then select the CSV file.

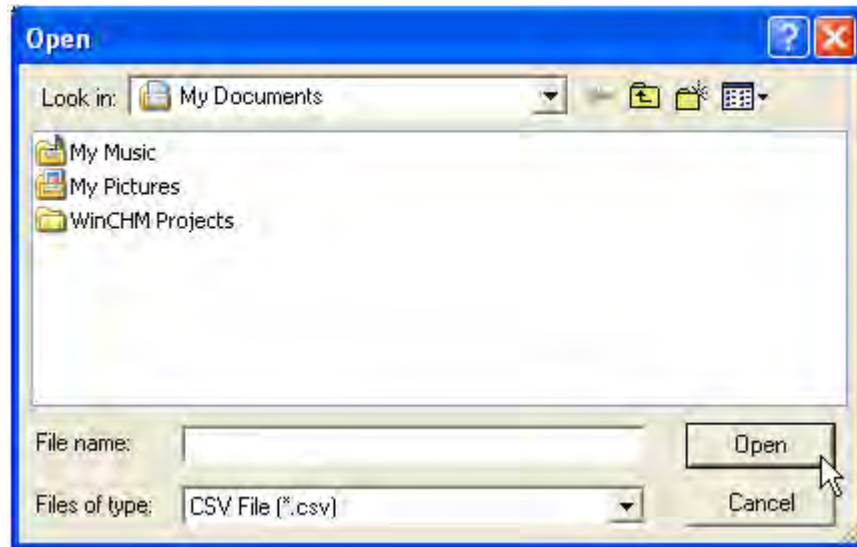

2.3.5 Parameters

(1) The input modes of the channels

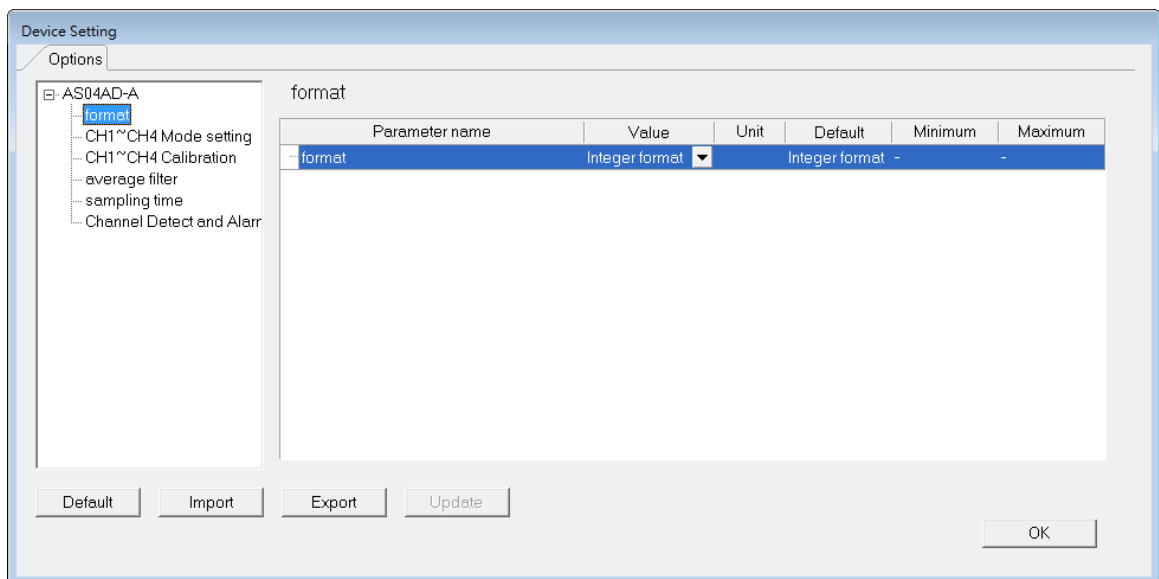

(2) The CH1~CH4 Mode settings

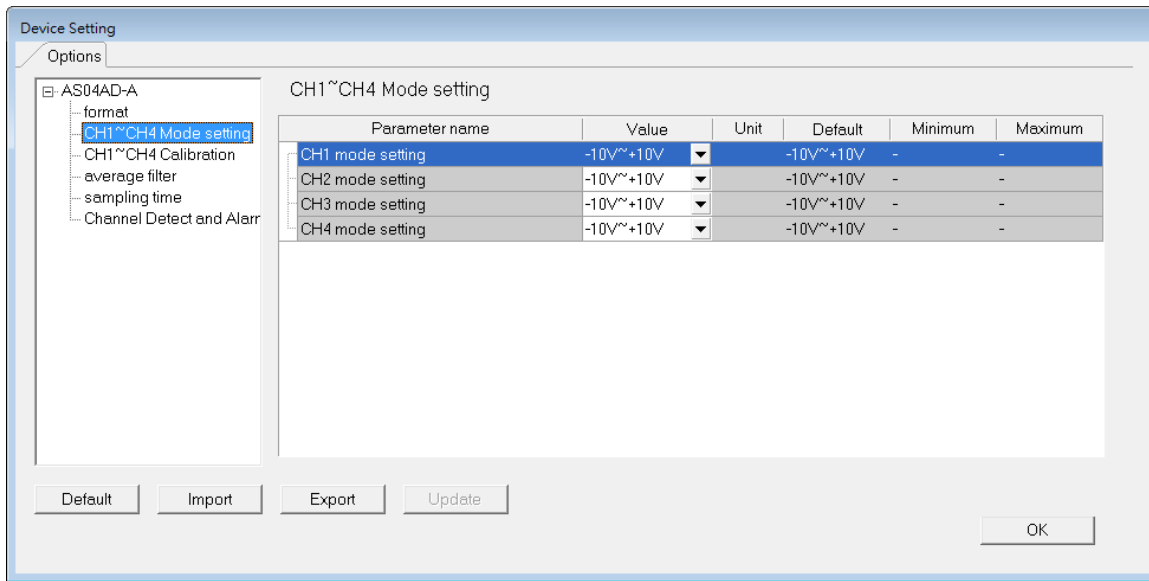

(3) The CH1~CH4 calibration settings

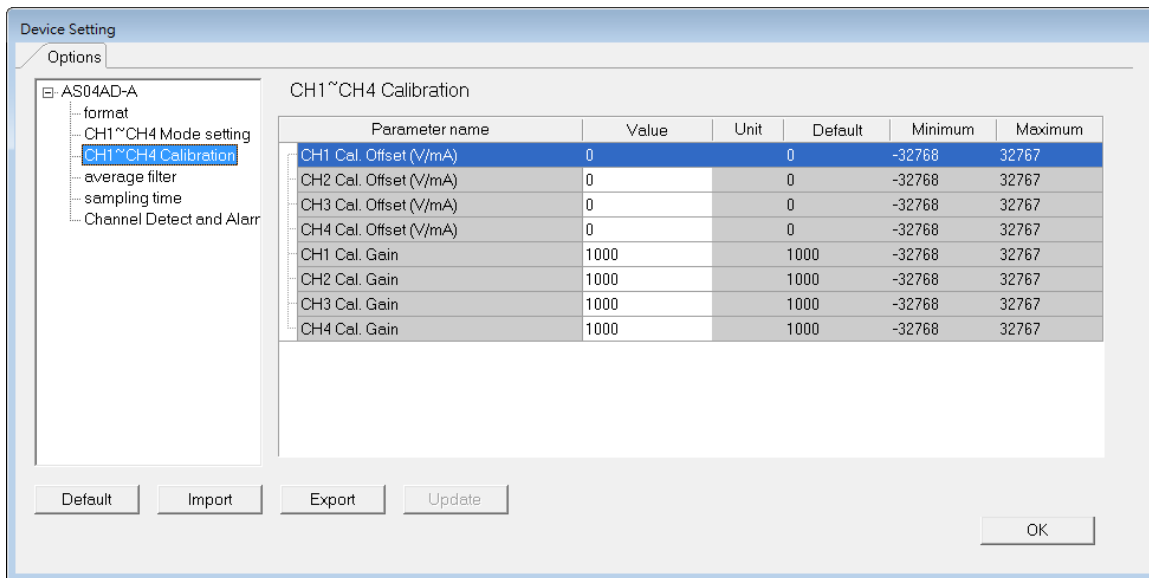

(4) The average filter settings

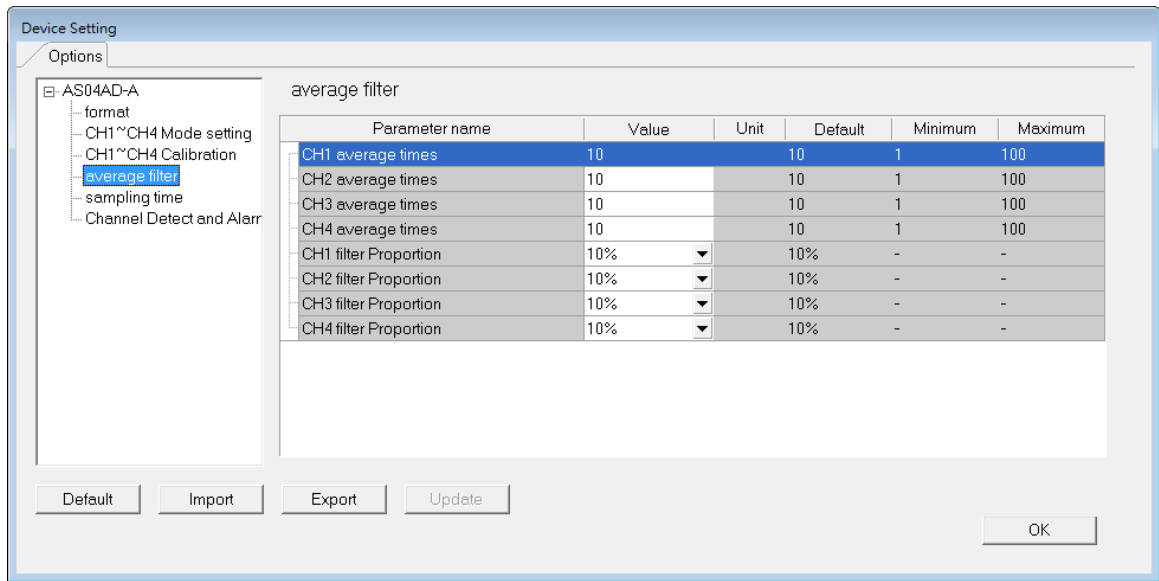

(5) The sampling time settings

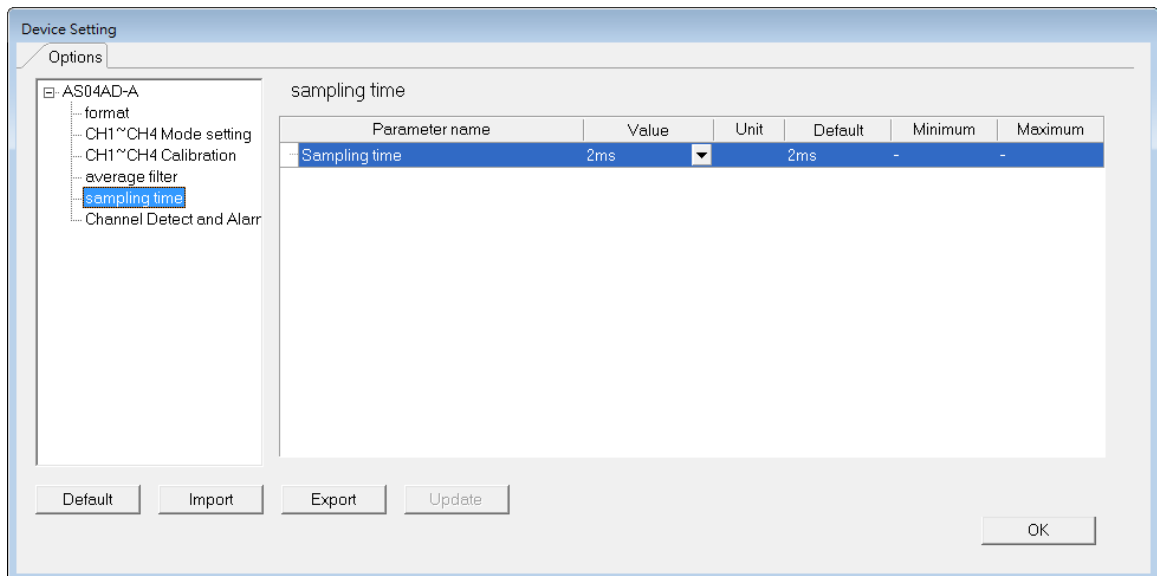

(6) The channel detect settings

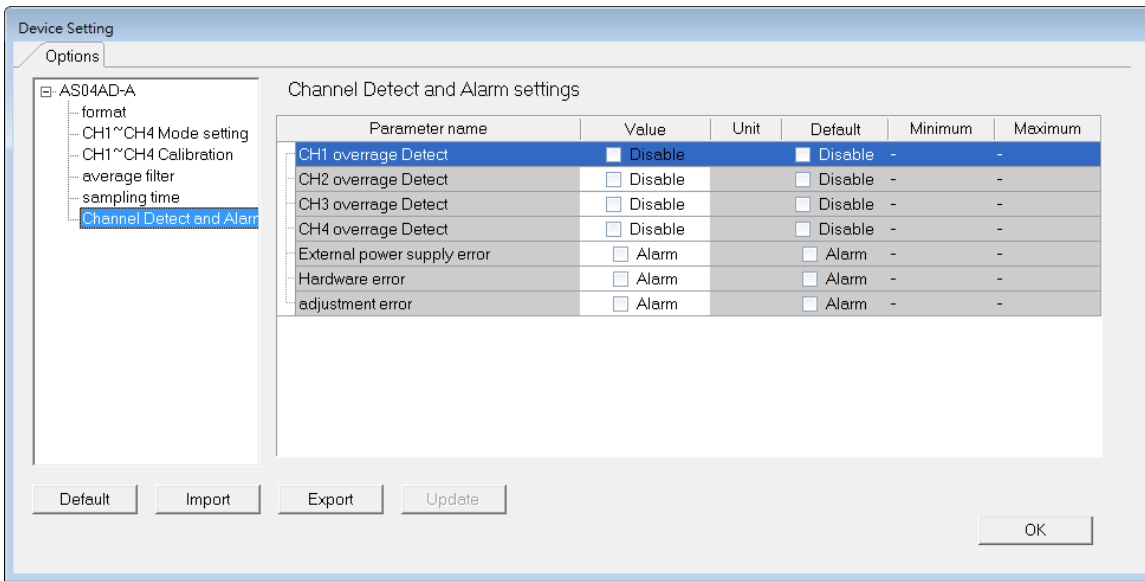

2.4 Troubleshooting

2.4.1 Error Codes

Error Code	Description	A → D LED indicator	ERROR LED indicator
16#1605	Hardware failure	OFF	ON
16#1607	The external voltage is abnormal.	OFF	ON
16#1608	The factory calibration is abnormal.	OFF	ON
16#1801	The external voltage is abnormal.	OFF	Blinking
16#1802	Hardware failure	OFF	Blinking
16#1804	The factory calibration is abnormal.	OFF	Blinking
16#1808	The signal received by channel 1 exceeds the range of inputs which can be received by the hardware.	Run: blinking Stop: OFF	Blinking
16#1809	The signal received by channel 2 exceeds the range of inputs which can be received by the hardware.		
16#180A	The signal received by channel 3 exceeds the range of inputs which can be received by the hardware.		
16#180B	The signal received by channel 4 exceeds the range of inputs which can be received by the hardware.		

2.4.2 Troubleshooting Procedure

Description	Procedure
The external voltage is abnormal.	Check whether the external 24 V power supply to the module is normal.
Hardware failure	Return the module to the factory for repair.
Internal error The factory correction is abnormal.	Please contact the factory.
The signal received by channel 1 exceeds the range of inputs which can be received by the hardware.	Check the signal received by channel 1
The signal received by channel 2 exceeds the range of inputs which can be received by the hardware.	Check the signal received by channel 2.
The signal received by channel 3 exceeds the range of inputs which can be received by the hardware.	Check the signal received by channel 3.
The signal received by channel 4 exceeds the range of inputs which can be received by the hardware.	Check the signal received by channel 4.

MEMO

2

Chapter 3 Analog Output Module AS04DA

Table of Contents

3.1 Overview	3-2
3.1.1 Characteristics	3-2
3.2 Specifications and Functions	3-2
3.2.1 Specifications	3-2
3.2.2 Profile.....	3-4
3.2.3 Arrangement of Terminals	3-5
3.2.4 Control Registers	3-5
3.2.5 Functions	3-7
3.2.6 Wiring	3-9
3.2.7 LED Indicators	3-11
3.3 HWCONFIG in ISPSOft	3-11
3.3.1 Initial Setting	3-11
3.3.2 Checking the Version of a Module.....	3-14
3.3.3 Online Mode	3-15
3.3.4 Importing/Exporting a Parameter File	3-16
3.3.5 Parameters	3-17
3.4 Troubleshooting	3-19
3.4.1 Error Codes	3-19
3.4.2 Troubleshooting Procedure	3-20

3.1 Overview

An analog output module receives four groups of 12-bit digital data from a CPU module. The digital data is converted into analog signals (voltages or currents).

3.1.1 Characteristics

(1) **A module is selected according to practical application.**

AS04DA-A: There are four channels. Outputs sent by a channel can be either voltages or currents.

(2) **High-speed conversion**

A digital signal is converted into an analog signal at a speed of 2ms a channel.

(3) **High accuracy**

Conversion accuracy: The error is $\pm 0.2\%$ of an output voltage, and $\pm 0.2\%$ of an output current. (The ambient temperature is 25°C.)

(4) **A module can be set by means of utility software.**

HWCONFIG is built-in utility software in ISPSOft. Users can set modes and parameters in HWCONFIG to complete hardware configuration without spending time writing a program to set registers corresponding to functions.

3.2 Specifications and Functions

3.2.1 Specifications

- **Electrical specifications**

Module name	AS04DA-A
Number of inputs	4
Analog-to-digital conversion	Voltage input/Current input
Supply voltage	24 VDC (20.4 VDC~28.8 VDC) (-15%~+20%)
Connector type	Removable terminal block
Conversion time	2ms/channel
Isolation	An analog circuit is isolated from a digital circuit by a digital integrated circuit/an optocoupler, but the analog channels are not isolated from one another. Isolation between a digital circuit and a ground: 500 VDC Isolation between an analog circuit and a ground: 500 VDC Isolation between an analog circuit and a digital circuit: 500 VDC Isolation between the 24 VDC and a ground: 500 VDC

● **Functional specifications**

Analog-to-digital conversion	Voltage input				
	Rated input range	$\pm 10\text{ V}$	$0\text{ V}\sim 10\text{ V}$	$\pm 5\text{ V}$	$0\text{ V}\sim 5\text{ V}$
Hardware input range	$-10.1\text{V}\sim 10.1\text{V}$	$-0.1\text{V}\sim 10.1\text{V}$	$-5.05\text{V}\sim 5.05\text{V}$	$-0.05\text{V}\sim 5.05\text{V}$	$0.95\text{V}\sim 5.05\text{V}$
Fiducial error (Room temperature)	$\pm 0.2\%$				
Fiducial error (Full temperature range)	$\pm 0.5\%$				
Linearity error (Room temperature)	$\pm 0.05\%$				
Linearity error (Full temperature range)	$\pm 0.05\%$				
Hardware resolution	12 bits				
Input impedance	$1\text{k}\Omega\sim 2\text{M}\Omega$ at $\pm 10\text{V}$ and $0\text{V}\sim 10\text{V}$				
Absolute input range	$\geq 500\Omega$ at $1\text{V}\sim 5\text{V}$				

Analog-to-digital conversion	Current input	
	Rated input range	$0\text{ mA}\sim 20\text{ mA}$
Hardware input range	$-0.2\text{ mA}\sim 20.2\text{ mA}$	$3.8\text{ mA}\sim 20.2\text{ mA}$
Fiducial error (Room temperature)	$\pm 0.2\%$	
Fiducial error (Full temperature range)	$\pm 0.5\%$	
Linearity error (Room temperature) (Full temperature range)	$\pm 0.03\%$	
Linearity error	$\pm 0.03\%$	
Hardware resolution	12 bits	
Input impedance	$\leq 550\ \Omega$	

3.2.2 Profile

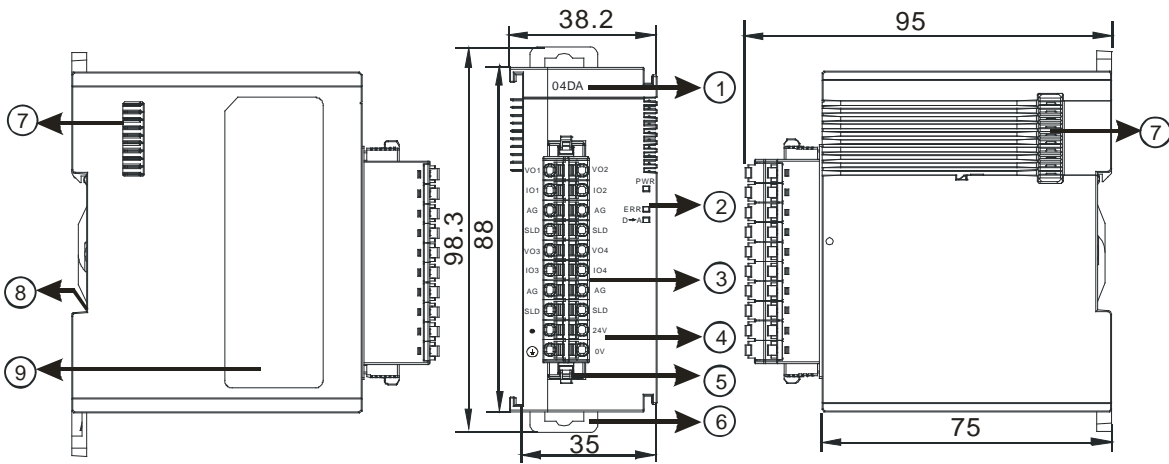

unit: mm

Number	Name	Description
1	Model name	Model name of the module
2	POWER LED indicator	Indicating the status of the power supply ON: the power is on OFF: no power
	ERROR LED indicator	Error status of the module ON: A serious error occurs in the module. OFF: The module is normal. Blinking: A slight error occurs in the module.
	Analog to digital conversion indicator	Indicating the analog to digital conversion status Blinking: conversion is taking place OFF: stop conversion
3	Removable terminal block	The outputs are connected to loads which will be driven.
4	Arrangement of the input/output terminals	Arrangement of the terminals
5	Terminal block clip	Removing the terminal block
6	DIN rail clip	Securing the module onto the DIN rail
7	Module connecting set	Connecting the modules
8	Ground clip	
9	Label	Nameplate

3.2.3 Arrangement of Terminals

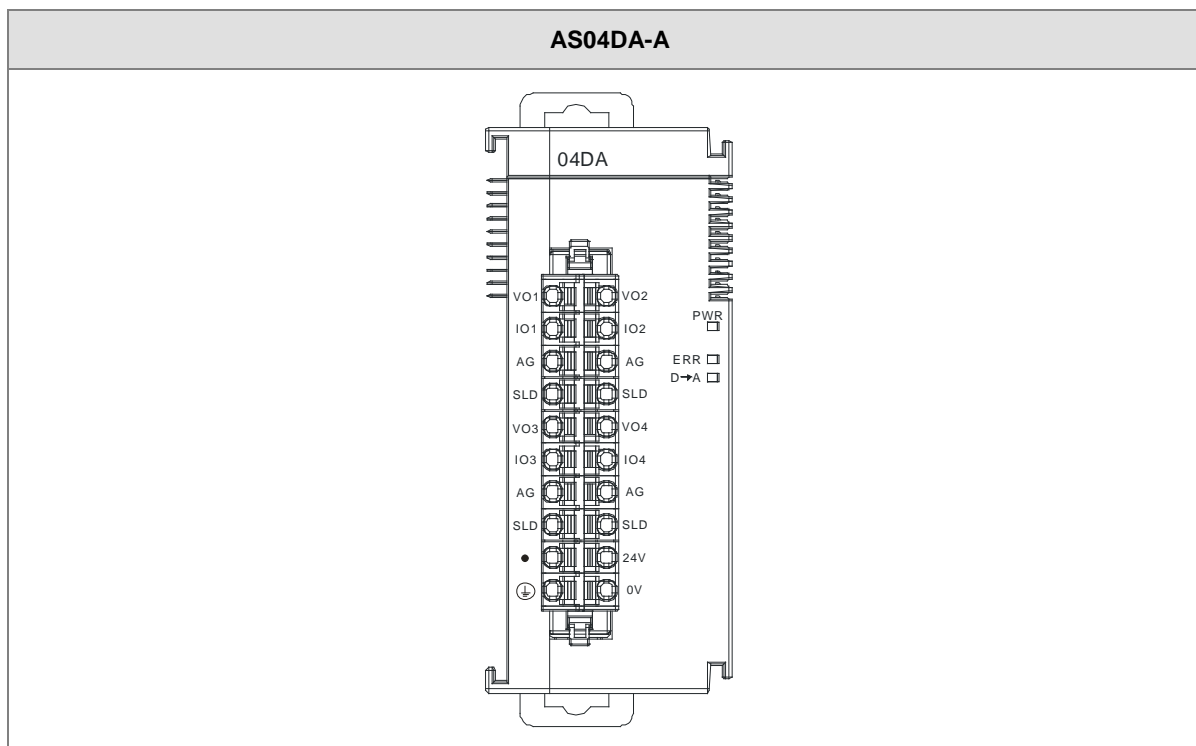

3.2.4 Control Registers

CR#	Name	Description	Defaults
0	Format setup	0: integer format 1: floating point format	0
1	Channel 1 mode setup	0: closed 1: -10V~10V (default)	1
2	Channel 2 mode setup	2: 0~10V 3: -5~5V	
3	Channel 3 mode setup	4: 0~5V 5: 1~5V	
4	Channel 4 mode setup	6: 0mA~20mA 7: 4mA~20mA	
5	Channel 1 offset	Setting range: -32768~32767	0
6	Channel 2 offset		
7	Channel 3 offset		
8	Channel 4 offset		
9	Channel 1 gain	Setting range: -32768~32767	1000

CR#	Name	Description	Defaults
10	Channel 2 gain		
11	Channel 3 gain		
12	Channel 4 gain		
13	Retaining an output sent by channel 1	0: when the PLC stops, the vaule of the analog output will be reset to 0. 1: when the PLC stops, the value of the analog output will be retained.	0
14	Retaining an output sent by channel 2		
15	Retaining an output sent by channel 3		
16	Retaining an output sent by channel 4		
17	Refreshing the time for an output sent by channel 1	Setting range: 10~3200 (100ms~32s); unit: 10ms For a value less than 10, it will be seen as 0. For a value bigger than 3200, the value will be seen as 3200. When the value is 0, this function is disabled.	0
18	Refreshing the time for an output sent by channel 2		
19	Refreshing the time for an output sent by channel 3		
20	Refreshing the time for an output sent by channel 4		
21	The minimum scale range for channel 1	The analog input mode of a channel has a corresponding digital range; that is, an analog range corresponds to a digital range. For example, if the analog range is -10 V~10 V and the digital range is -10.0~10.0, the analog values -10 V~10 V correspond to the digital values -10.0~10.0. If the analog input mode of a channel is 4mA~20mA, it means the minumium scale range is 4mA and the maximum scale range is 20mA. When the format is interger format, the scale range is invalid.	-10
22			
23	The minimum scale range for channel 2		-10
24			
25	The minimum scale range for channel 3		-10
26			
27	The minimum scale range for channel 4		-10
28			
29	The maximum scale range for channel 1		10
30			
31	The maximum scale range for channel 2	10	
32			
33	The maximum scale range for channel 3	10	
34			

CR#	Name	Description	Defaults
35	The maximum scale range for channel 4		10
36			
37	Channel alarm setup	0: warning 1: alarm bit0: Error occurs in the module power bit1: Error occurs in the module hardware bit2: Error occurs in calibration	0

3.2.5 Functions

Item	Function	Description
1	Enabling/Disabling a channel	1. Users can enable or disable a channel. 2. If a channel is disabled, the total conversion time is decreased.
2	Calibration	Users can calibrate a linear curve.
3	Retaining an output	When a module stops running, a signal sent by the module is retained.
4	Refreshing time for an output	Refreshing the analog output value according to the value of the fixed slope
5	Scale range	When the format is floating-point numbers, the scale range can be set.

1. Enabling/Disabling a channel

An analog signal is converted into a digital signal at a speed of 2ms a channel. The total conversion time is 2ms X (the number of channels). If a channel is not used, users can disable it to decrease the total conversion time.

2. Calibration

- To make a curve meet actual needs, users can calibrate the curve by changing an offset and a gain. A calibration range depends on a range of inputs which can be received by hardware. The formula is as below.

$$Output = \frac{(Input \times Gain)}{1000} + Offset$$

Example:

The inputs received by a channel are voltages in the range of -10.0 V to +10.0 V. The gain is 1000, and the offset is 0. The corresponding value for the original signal -10.0 V to +10.0 V is -32000~32000. When using the offset -100, the calibrated value for the original signal -10.0 V to +10.0 V is -31900~32100.

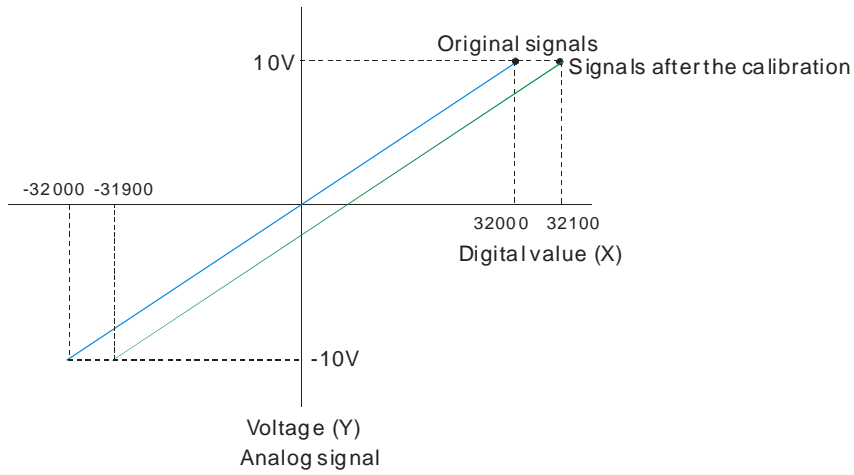

3

3. Retaining an output

When a module stops running, a signal sent by the module is retained.

The output is not retained:

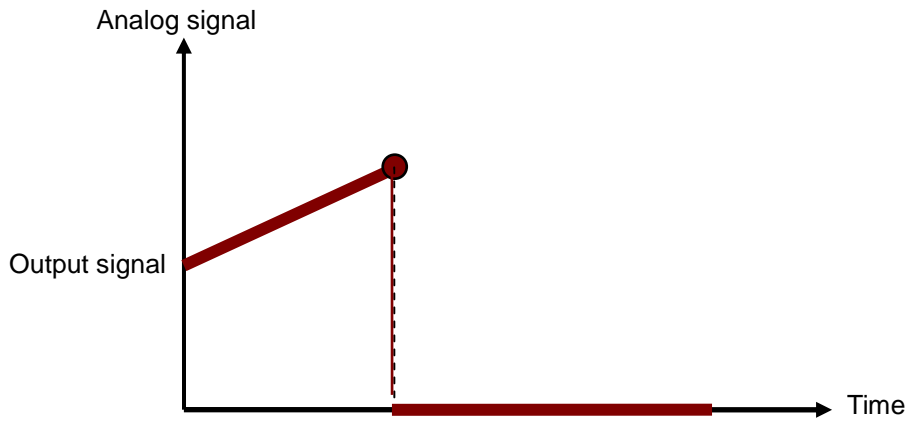

3. Refreshing time for an output

Users set the refreshing time for an output and the value of the slope (m) will be updated accordingly.

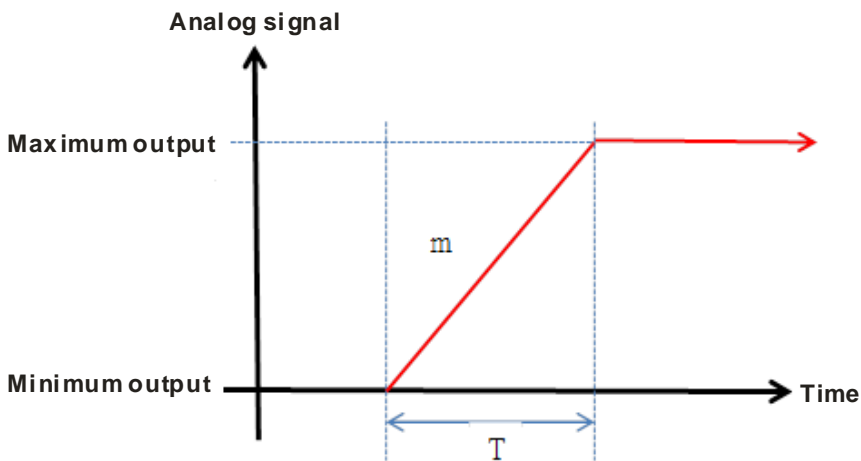

When the analog output signal changes, the value of the analog output will be updated according to the value set in the slope as the image shown below.

Analog signal

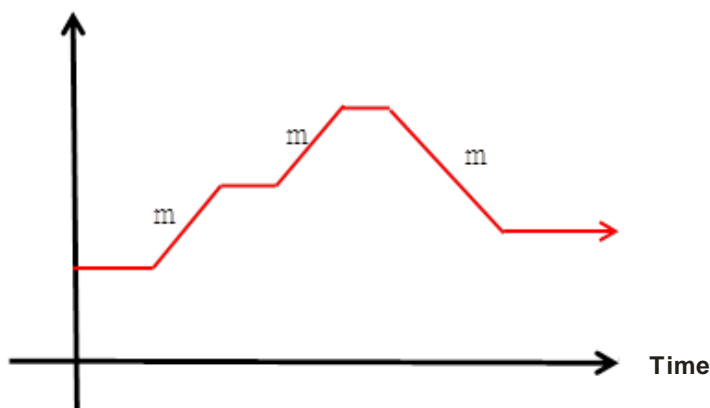

4. Scale range

When the format is floating-point numbers, the scale range can be set. The analog output mode of a channel has a corresponding digital range. Digital values correspond to analog outputs sent by a module. For example, if the analog range is $-10\text{ V}\sim 10\text{ V}$, the digital range is $-10.0\sim 10.0$ and the scale HSP is 10.0 and the scale LSP is -10.0 . The digital values $-10.0\sim 10.0$ correspond to the analog values $-10\text{ V}\sim 10\text{ V}$ as the example shown below.

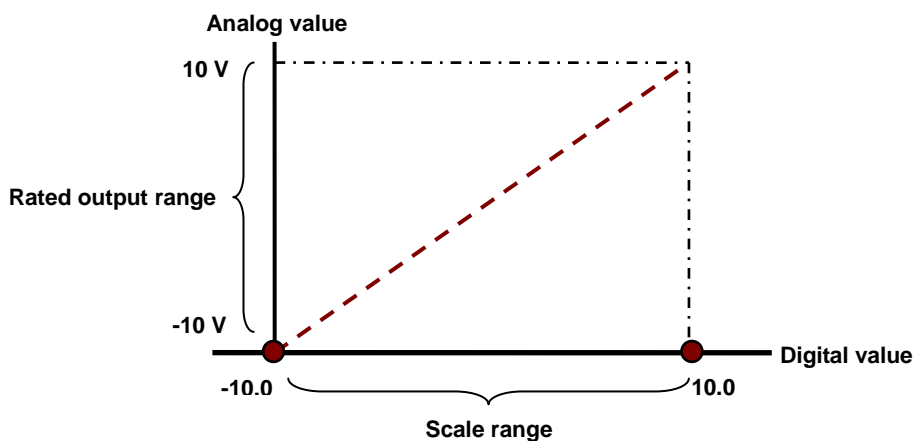

3.2.6 Wiring

- Precautions

In order to make the functions of a digital-to-analog module perfect and ensure the reliability of a system at the same time, external wiring which prevents noise is necessary. Before installing cables, users need to follow the precautions below.

- (1) To prevent a surge and induction, an AC cable and the output signal cables which are connected to AS04DA-A must be separate cables.

- (2) A cable must not be installed near a main circuit, a high-voltage cable, or a cable connected to a load which is not a PLC. Besides, a cable must not be bound to a main circuit, a high-voltage cable, or a cable connected to a load which is not a PLC. Otherwise, effects that noise, induction, and a surge have will increase.
- (3) Please connect a shielded cable and a hermetically sealed cable with the ground separately.
- (4) Terminals with insulation sleeves can not be arranged as a terminal block. It is recommended that the terminals be covered with insulation tubes.
- (5) Please connect 24 to 22 AWG (1 mm) wires to the input/output terminals. The lengths of the plastic jackets which are removed from the cables used should be in the range of 8 mm to 10 mm. The specifications for the terminals and the wiring of the terminals are shown below. Only copper leads which can resist the heat above 60/75°C can be used.

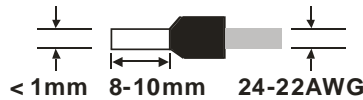

● External wiring

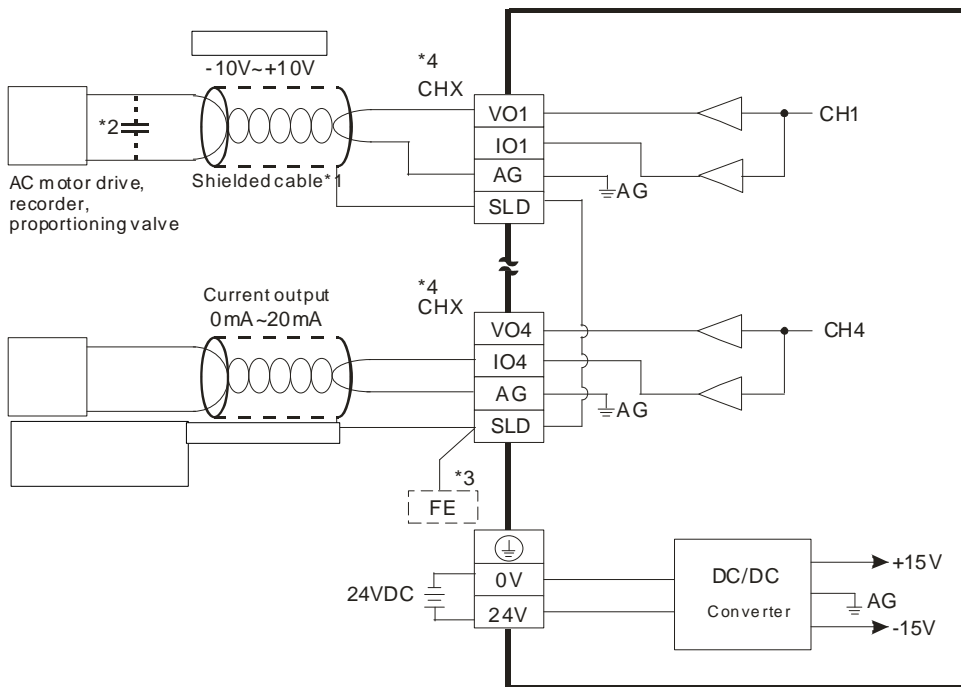

- *1. Please use shielded cables to isolate the analog input signal cable from other power cables.
- *2. If the ripple in the input voltage results in the noise interference with the wiring, please connect the module to the capacitor having a capacitance in the range of 0.1 μF to 0.47 μF with a working voltage of 25 V.
- *3. Please connect the SLD to FE and the FE and the terminal \oplus should be connected to earth ground.
- *4. Every channel can work with the wiring presented above.

3.2.7 LED Indicators

Number	Name	Description
1	RUN LED indicator	Operating status of the module ON: The module is running. OFF: The module stops running.
2	ERROR LED indicator	Error status of the module ON: A serious error occurs in the module. OFF: The module is normal. Blink: A slight error occurs in the module.
3	Digital to analog conversion indicator	Indicating the digital to analog conversion status Blinking: conversion is taking place OFF: stop conversion

3.3 HWCONFIG in ISPSoft

3.3.1 Initial Setting

- (1) Start ISPSoft, and then double-click **HWCONFIG**.

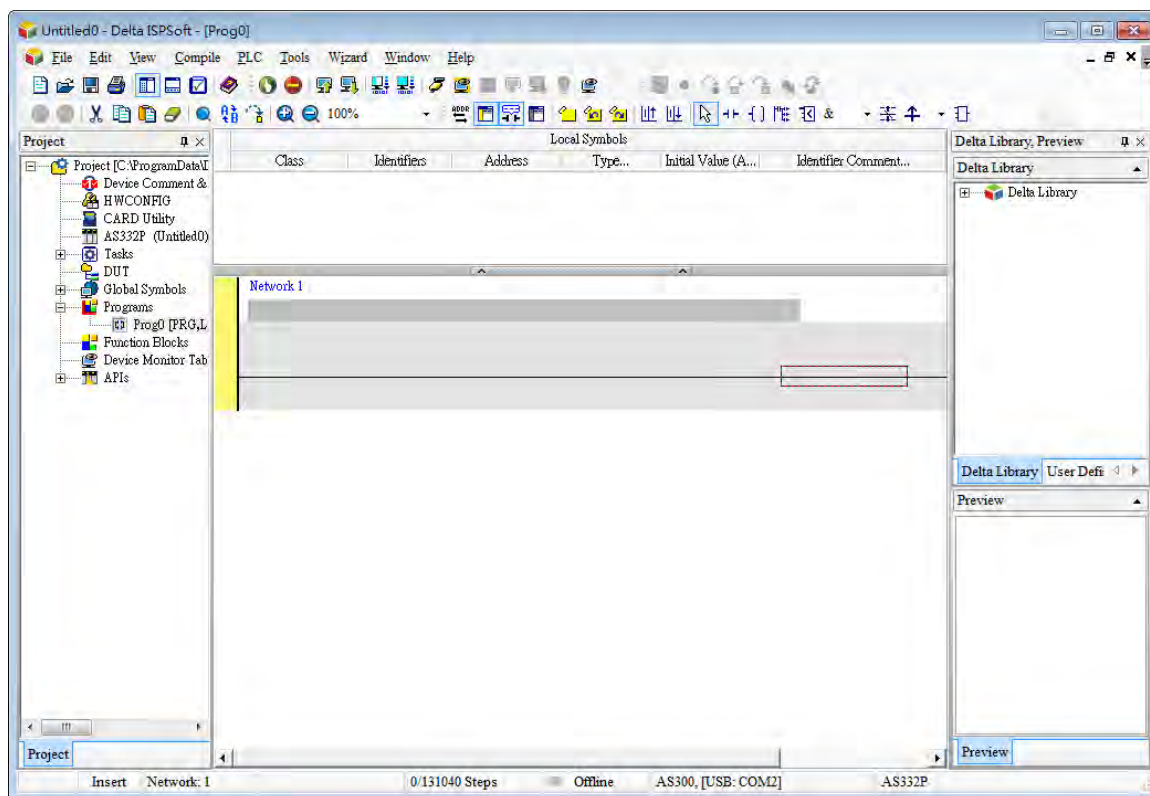

(2) Selecting a module.

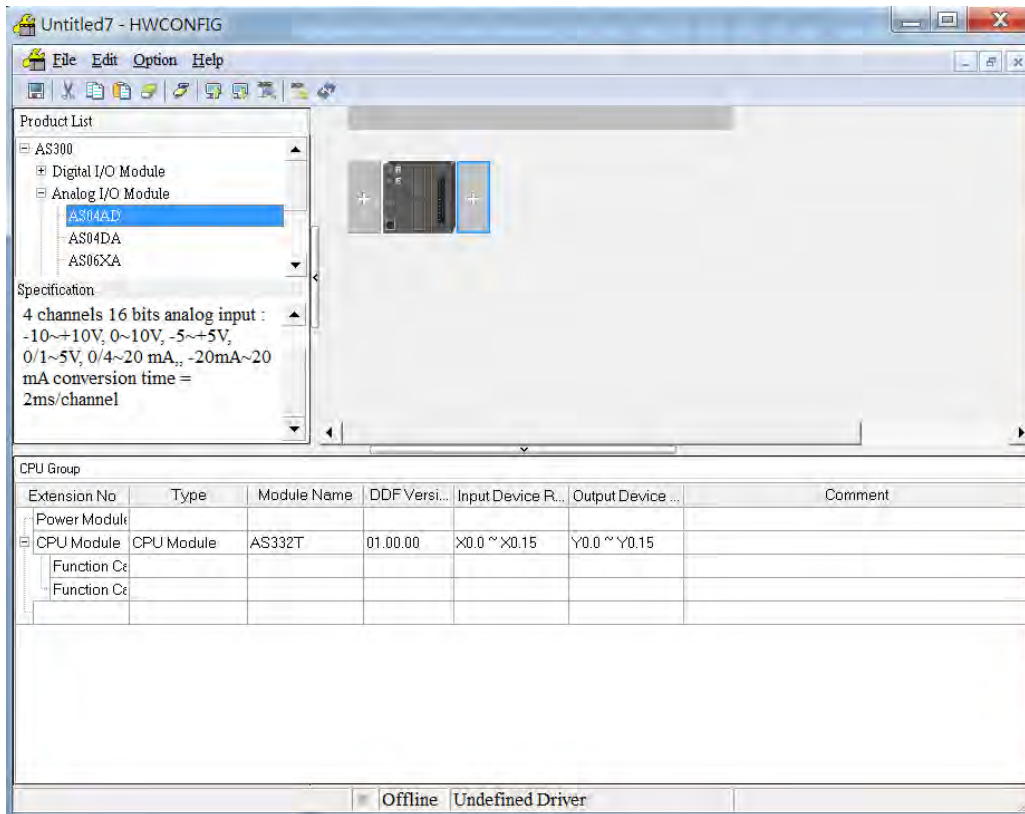

(3) Double-click the module to open the Device Setting page.

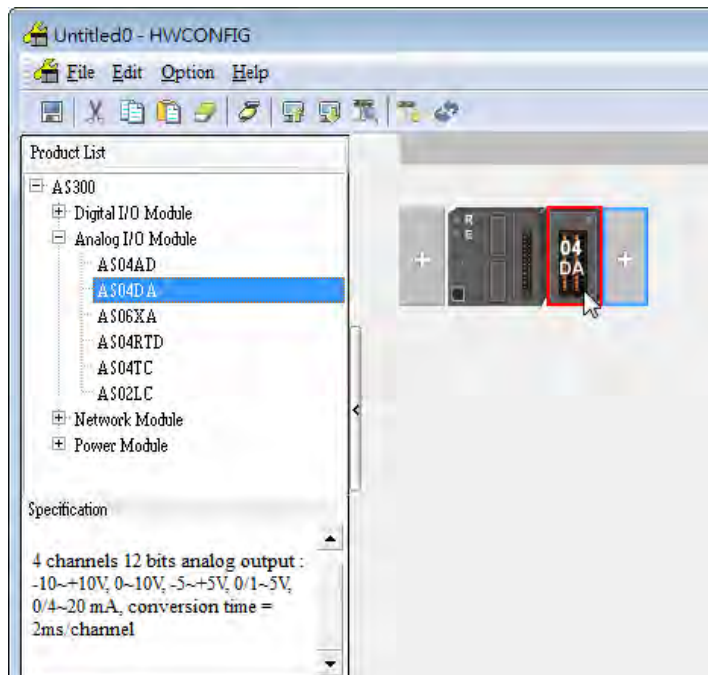

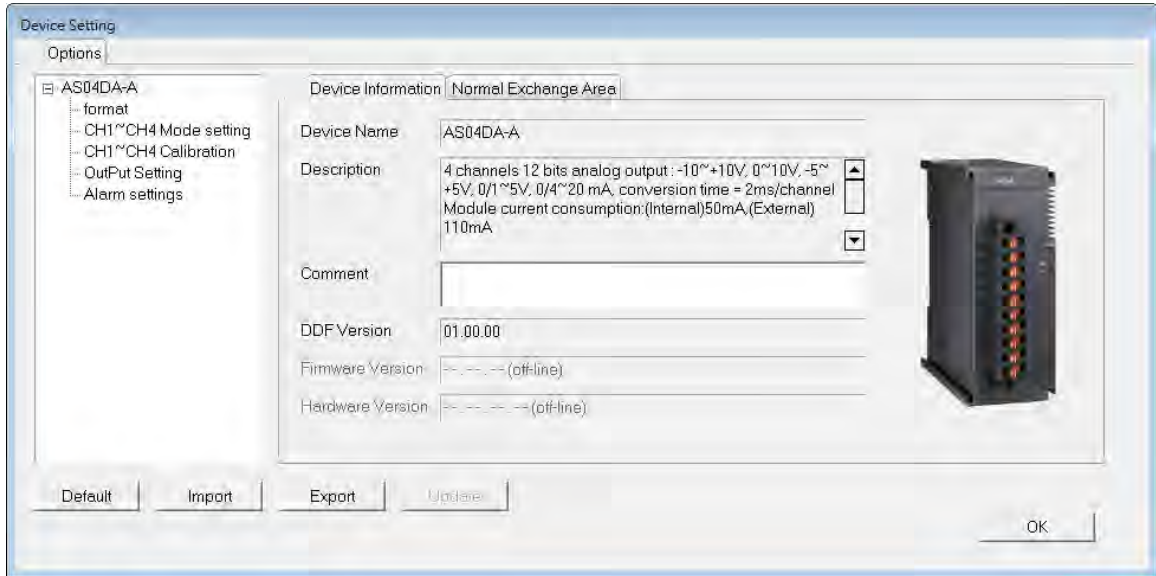

(4) Set the parameters, and then click **OK**.

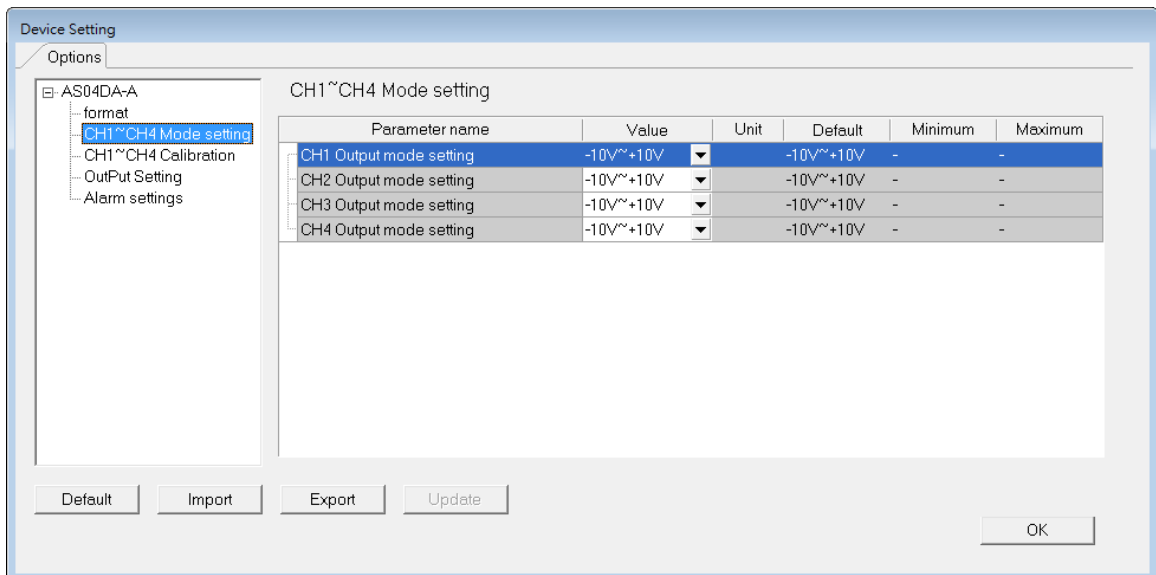

- (5) Click **Download** on the toolbar to download the parameters. (The parameters can not be downloaded when the CPU module runs.)

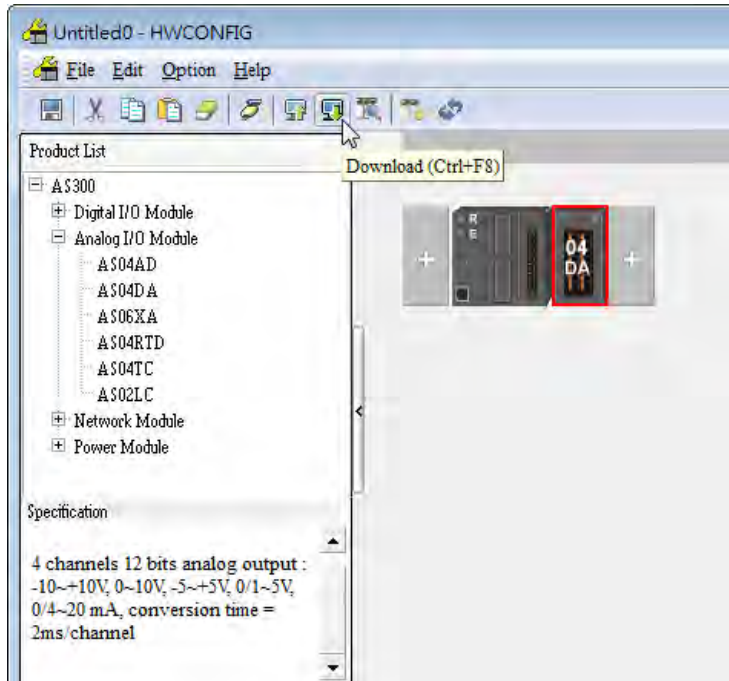

3.3.2 Checking the Version of a Module

- (1) On the **Option** menu, click **Online Mode**.

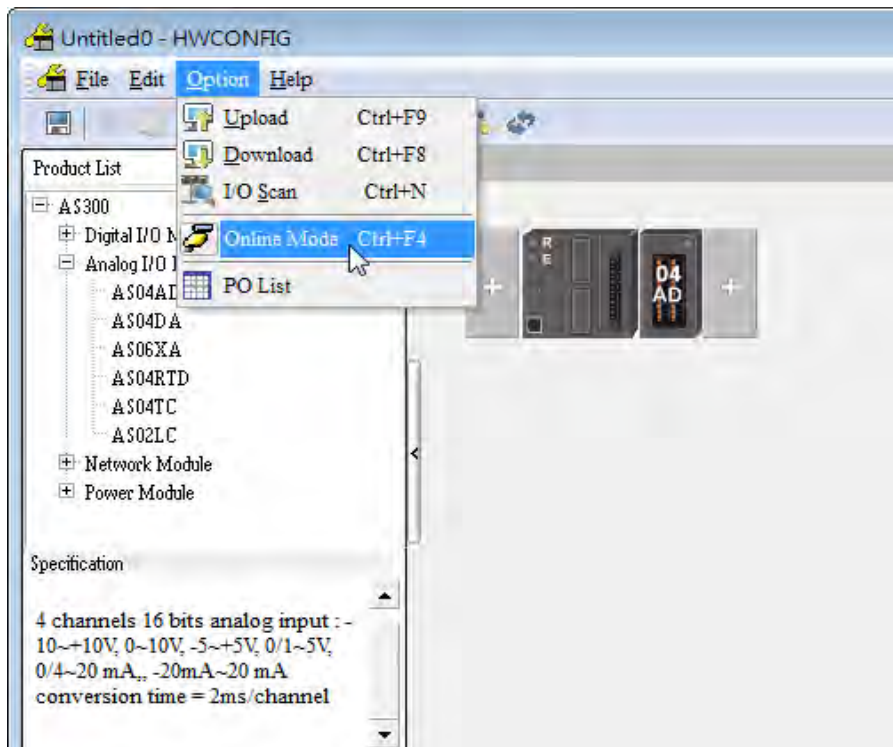

- (2) Double-click the module to see the Device Setting page. The version of the firmware and that of the hardware are displayed.

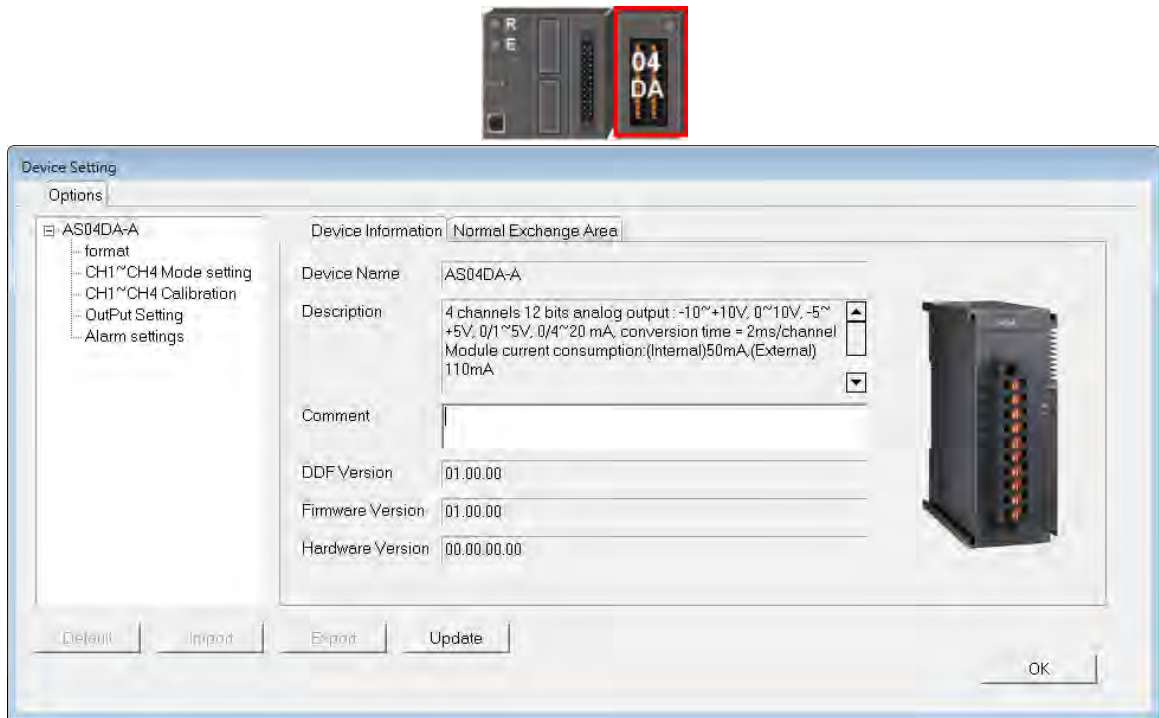

3.3.3 Online Mode

- (1) Click **Online Mode** on the toolbar.

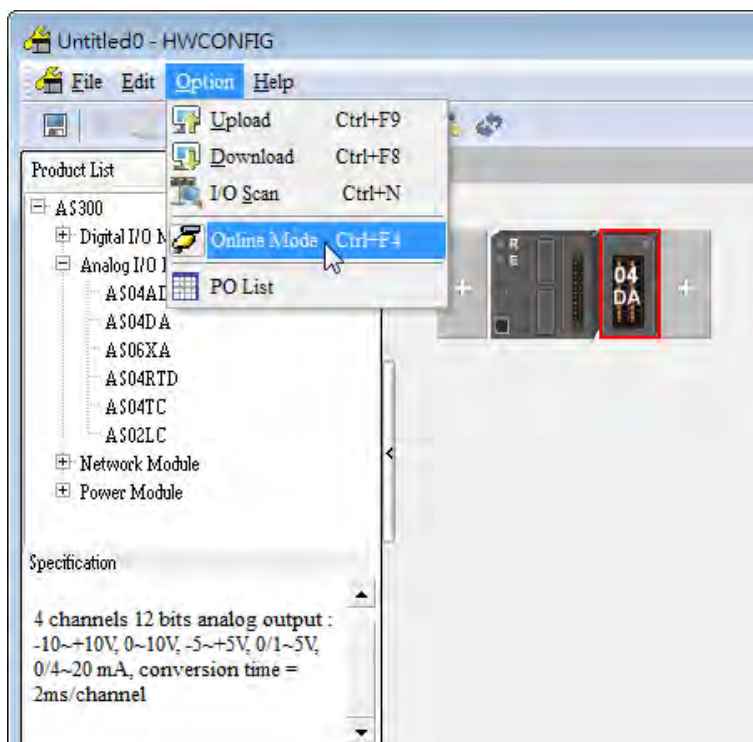

(2) Right-click the module.

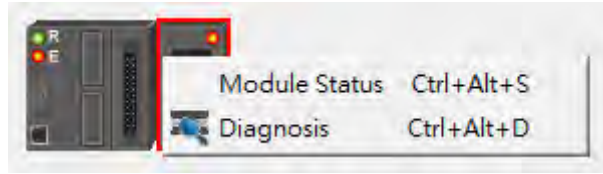

(3) The module status can be shown.

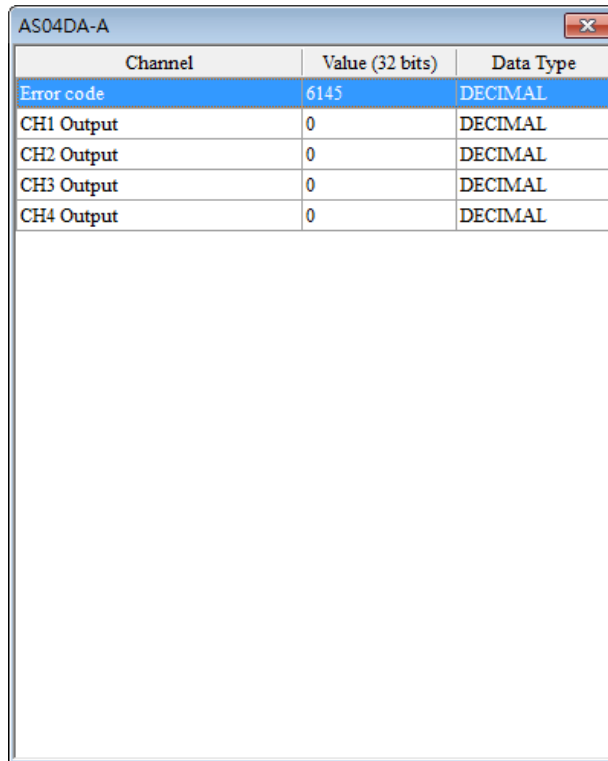

Channel	Value (32 bits)	Data Type
Error code	6145	DECIMAL
CH1 Output	0	DECIMAL
CH2 Output	0	DECIMAL
CH3 Output	0	DECIMAL
CH4 Output	0	DECIMAL

3.3.4 Importing/Exporting a Parameter File

(1) After **Export** is clicked, the parameters will be saved as a CSV file (.csv).

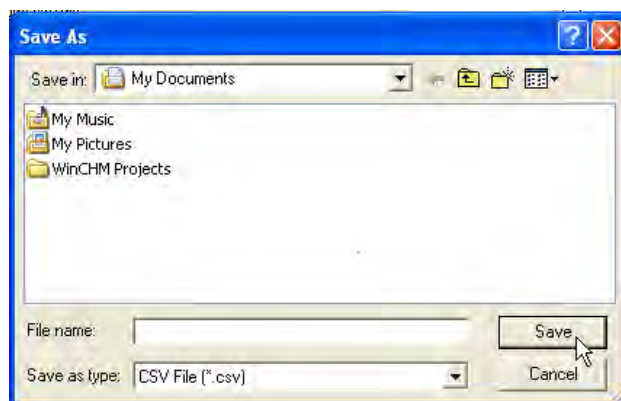
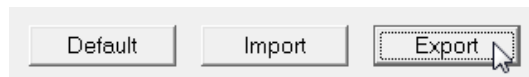



(2) Click **Import**, and then select the CSV file.

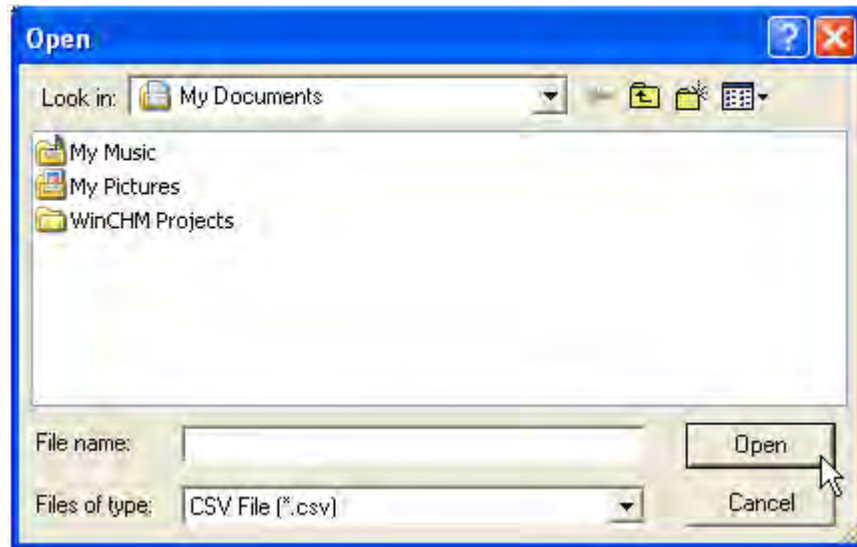

3

3.3.5 Parameters

(1) The input modes of the channels

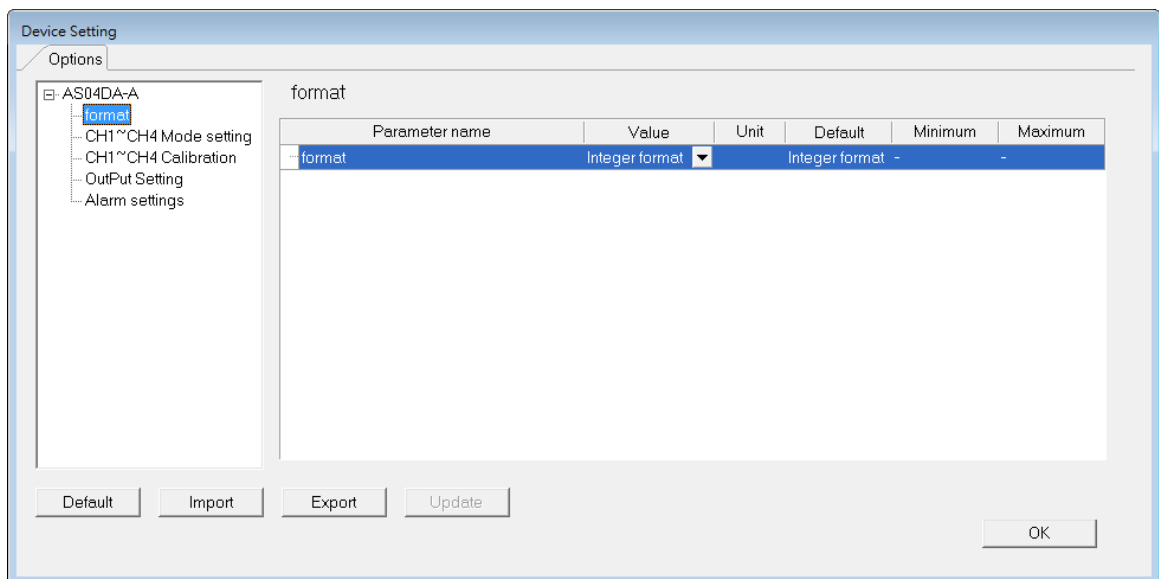

(2) The CH1~CH4 Mode settings

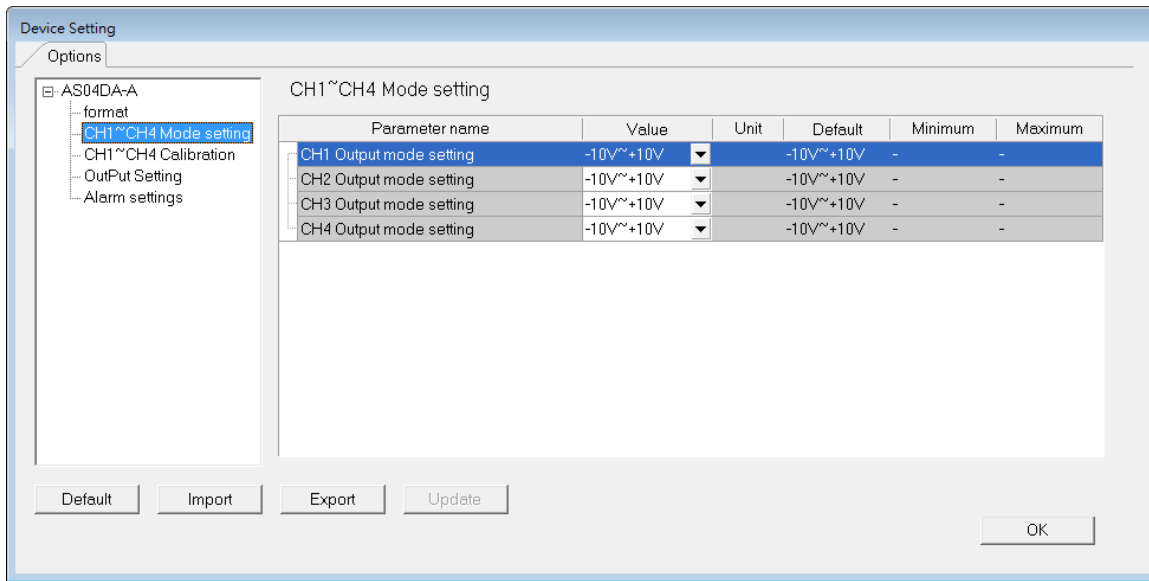

(3) The CH1~CH4 calibration settings

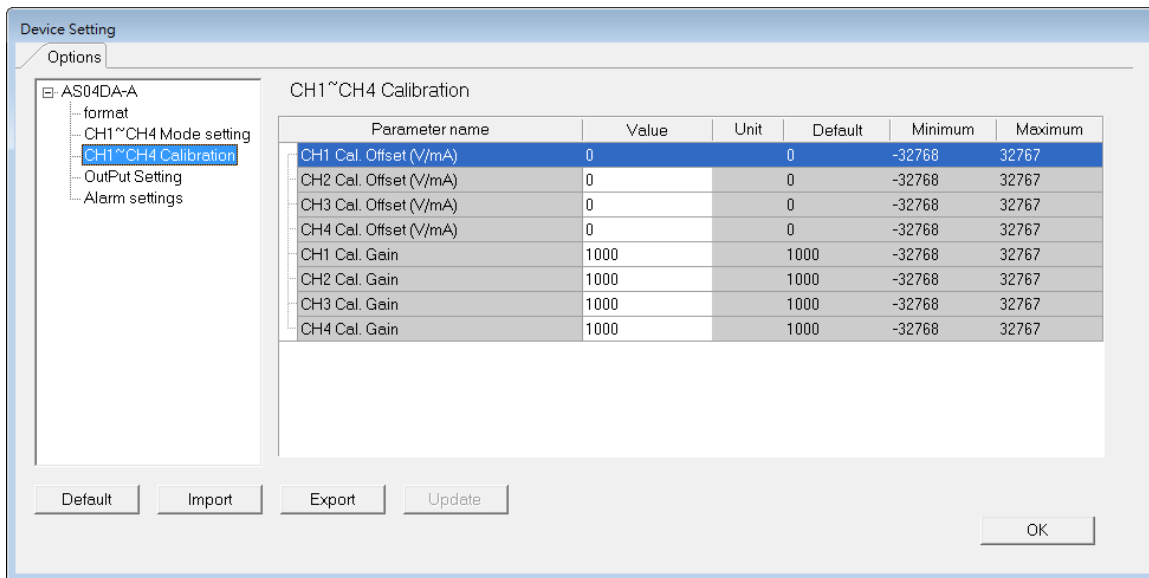

(4) The output settings

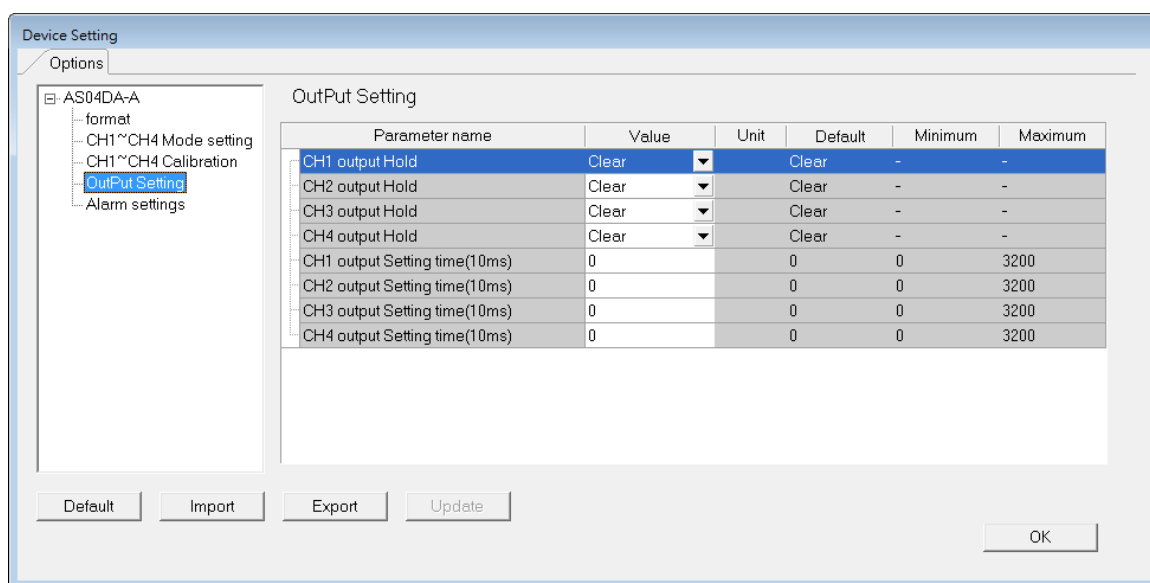

(5) The alarm settings

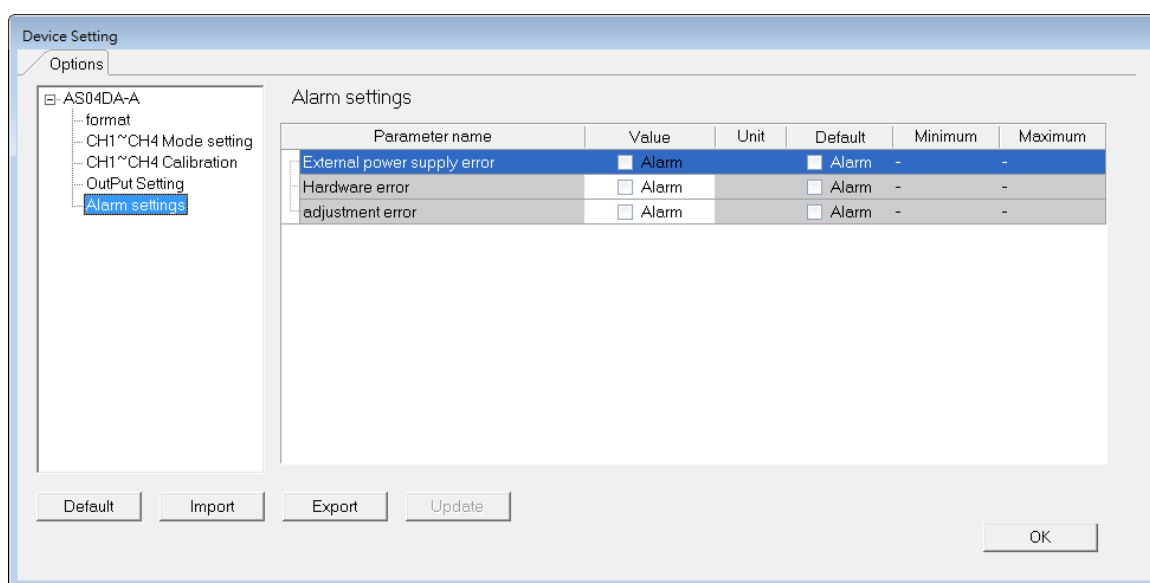

3.4 Troubleshooting

3.4.1 Error Codes

Error Code	Description	D → A LED indicator	ERROR LED indicator
16#1605	Hardware failure	OFF	ON
16#1607	The external voltage is abnormal.	OFF	ON
16#1608	The factory calibration is abnormal.	OFF	ON
16#1801	The external voltage is abnormal.	OFF	Blinking

Error Code	Description	D → A LED indicator	ERROR LED indicator
16#1802	Hardware failure	OFF	Blinking
16#1804	The factory calibration is abnormal.	OFF	Blinking

3.4.2 Troubleshooting Procedure

Description	Procedure
The external voltage is abnormal.	Check whether the external 24 V power supply to the module is normal.
Hardware failure	Return the module to the factory for repair.
Internal error The factory correction is abnormal.	Please contact the factory.

Chapter 4 Analog Input/Output Module AS06XA

Table of Contents

4.1 Overview	4-2
4.1.1 Characteristics.....	4-2
4.2 Specifications and Functions	4-2
4.2.1 Specifications	4-2
4.2.2 Profile.....	4-5
4.2.3 Arrangement of Terminals	4-6
4.2.4 Control Registers	4-7
4.2.5 Functions.....	4-12
4.2.6 Wiring	4-18
4.2.7 LED Indicators.....	4-20
4.3 HWCONFIG in ISPSOft	4-21
4.3.1 Initial Setting	4-21
4.3.2 Checking the Version of a Module.....	4-24
4.3.3 Online Mode.....	4-25
4.3.4 Importing/Exporting a Parameter File	4-26
4.3.5 Parameters	4-27
4.4 Troubleshooting	4-31
4.4.1 Error Codes.....	4-31
4.4.2 Troubleshooting Procedure	4-32

4.1 Overview

The specifications for an analog input/output module, the operation, and the programming are described in this chapter. Analog signals (voltages or currents) are received by four channels on an analog input/output module, and are converted into 16-bit digital signals. Besides, the analog input/output module receives two pieces of 16-bit digital data from a CPU module. The digital data is converted into analog signals (voltages or currents). The analog signals are sent by two channels on the analog input/output module.

4.1.1 Characteristics

- (1) **AS06XA-A, an analog input/output module, is used according to practical application.**

CH1~CH4: Inputs received by a channel can be either voltages or currents.

CH5~CH6: Outputs sent by a channel can be either voltages or currents.

- (2) **High-speed conversion**

The conversion speed is 2ms a channel.

- (3) **High accuracy**

Conversion accuracy: The ambient temperature is 25°C.

Input: The error is $\pm 0.2\%$ of an input voltage, and $\pm 0.2\%$ of an input current.

Output: The error is $\pm 0.02\%$ of an output voltage, and $\pm 0.2\%$ of an output current.

- (4) **A module can be set by means of utility software.**

HWCONFIG is built-in utility software in ISPSOft. Users can set modes and parameters in HWCONFIG to complete hardware configuration without spending time writing a program to set registers corresponding to functions.

4.2 Specifications and Functions

4.2.1 Specifications

- **Electrical specifications**

Module name	AS06XA-A
Number of analog inputs/outputs	4 inputs 2 outputs
Analog-to-digital conversion	Voltage input/Current input/Voltage output/Current output
Supply voltage	24 V DC (20.4 V DC~28.8 V DC) (-15%~+20%)

Module name	AS06XA-A
Connector type	Removable terminal block
Conversion time	2ms/channel
Isolation	An analog circuit is isolated from a digital circuit by a digital integrated circuit/an optocoupler, but the analog channels are not isolated from one another. Isolation between a digital circuit and the ground: 500 V DC Isolation between an analog circuit and the ground: 500 V DC Isolation between an analog circuit and a digital circuit: 500 V DC Isolation between the 24 V DC and the ground: 500 V DC

- **Functional specifications for the analog-to-digital conversion**

Analog-to-digital conversion	Voltage input				
	-10 V~10 V	0 V~10 V	±5 V	0 V~5 V	1 V~5 V
Rated input range	-10 V~10 V	0 V~10 V	±5 V	0 V~5 V	1 V~5 V
Hardware input range	-10.1 V~10.1 V	-0.1 V~10.1 V	-5.05 V~5.05 V	-0.05 V~5.05 V	0.95 V~5.05 V
Fiducial error (Room temperature)	±0.2%				
Fiducial error (Full temperature range)	±0.5%				
Linearity error (Room temperature)	±0.02%				
Linearity error (Full temperature range)	±0.06%				
Hardware resolution	16 bits				
Input impedance	2MΩ				
Absolute input range	±15 V				

Analog-to-digital conversion	Current input		
	±20 mA	0 mA~20 mA	4 mA~20 mA
Rated input range	±20 mA	0 mA~20 mA	4 mA~20 mA
Hardware input range	-20.2 mA~20.2 mA	-0.2 mA~20.2 mA	3.8 mA~20.2 mA
Fiducial error (Room temperature)	±0.2%		
Fiducial error (Full temperature range)	±0.5%		

Linearity error (Room temperature)	$\pm 0.04\%$
Linearity error (Full temperature range)	$\pm 0.10\%$
Hardware resolution	16 bits
Input impedance	250 Ω
Absolute input range	± 32 mA

- Functional specifications for the digital-to-analog conversion

Digital-to-analog conversion	Voltage output				
	± 10 V	0V~10 V	± 5 V	0 V~5 V	1 V~5 V
Rated output range	± 10 V	0V~10 V	± 5 V	0 V~5 V	1 V~5 V
Hardware output range	-10.1 V~10.1 V	-0.1 V~10.1 V	-5.05 V~5.05 V	-0.05 V~5.05 V	0.95 V~5.05 V
Fiducial error (Room temperature)	$\pm 0.2\%$				
Fiducial error (Full temperature range)	$\pm 0.5\%$				
Linearity error (Room temperature)	$\pm 0.05\%$				
Linearity error (Full temperature range)	$\pm 0.05\%$				
Hardware resolution	16 bits				
Permissible load impedance	1 k Ω ~2 M Ω : ± 10 V and 0 V~10 V ≥ 500 Ω : 1 V~5 V				

Digital-to-analog conversion	Current output	
	0 mA~20 mA	4 mA~20 mA
Rated output range	0 mA~20 mA	4 mA~20 mA
Hardware output range	-0.2 mA~20.2 mA	3.8 mA~20.2 mA
Fiducial error (Room temperature)	$\pm 0.2\%$	
Fiducial error (Full temperature range)	$\pm 0.5\%$	

Linearity error (Room temperature)	$\pm 0.03\%$
Linearity error (Full temperature range)	$\pm 0.10\%$
Hardware resolution	12 bits
Permissible load impedance	$\leq 550 \Omega$

4.2.2 Profile

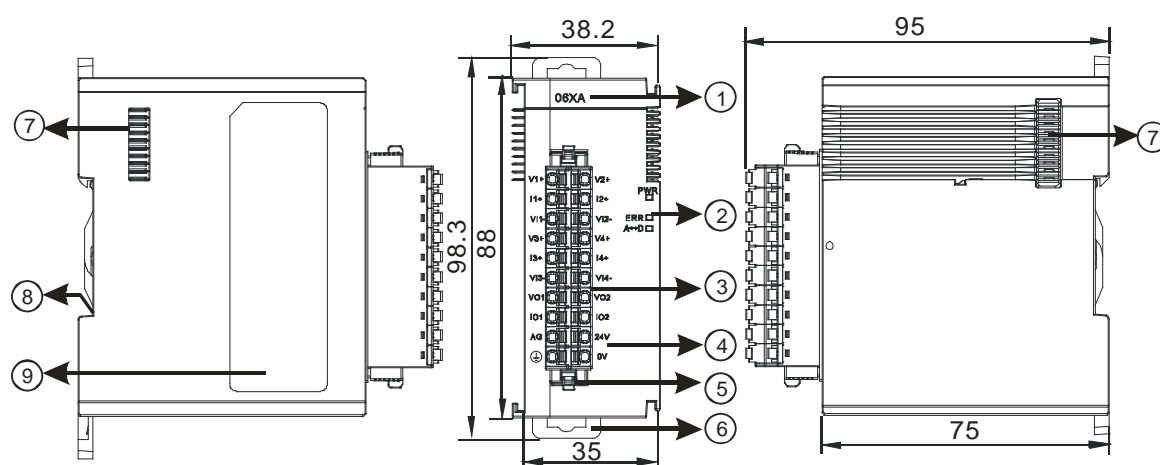

Unit: mm

Number	Name	Description
1	Model name	Model name of the module
2	RUN LED indicator	Operating status of the module ON: The module is running. OFF: The module stops running.
	ERROR LED indicator	Error status of the module ON: A serious error occurs in the module. OFF: The module is normal. Blink: A slight error occurs in the module.
	Digital to analog conversion indicator	Indicating the digital to analog conversion status Blinking: conversion is taking place OFF: stop conversion
3	Removable terminal block	The inputs are connected to transducers. The outputs are connected to loads which will be driven.

Number	Name	Description
4	Arrangement of the input/output terminals	Arrangement of the terminals
5	Clip	Removing the terminal block
6	DIN rail clip	Securing the module onto the DIN rail
7	Module connecting set	Connecting the modules
8	Ground clip	
9	Label	Nameplate

4

4.2.3 Arrangement of Terminals

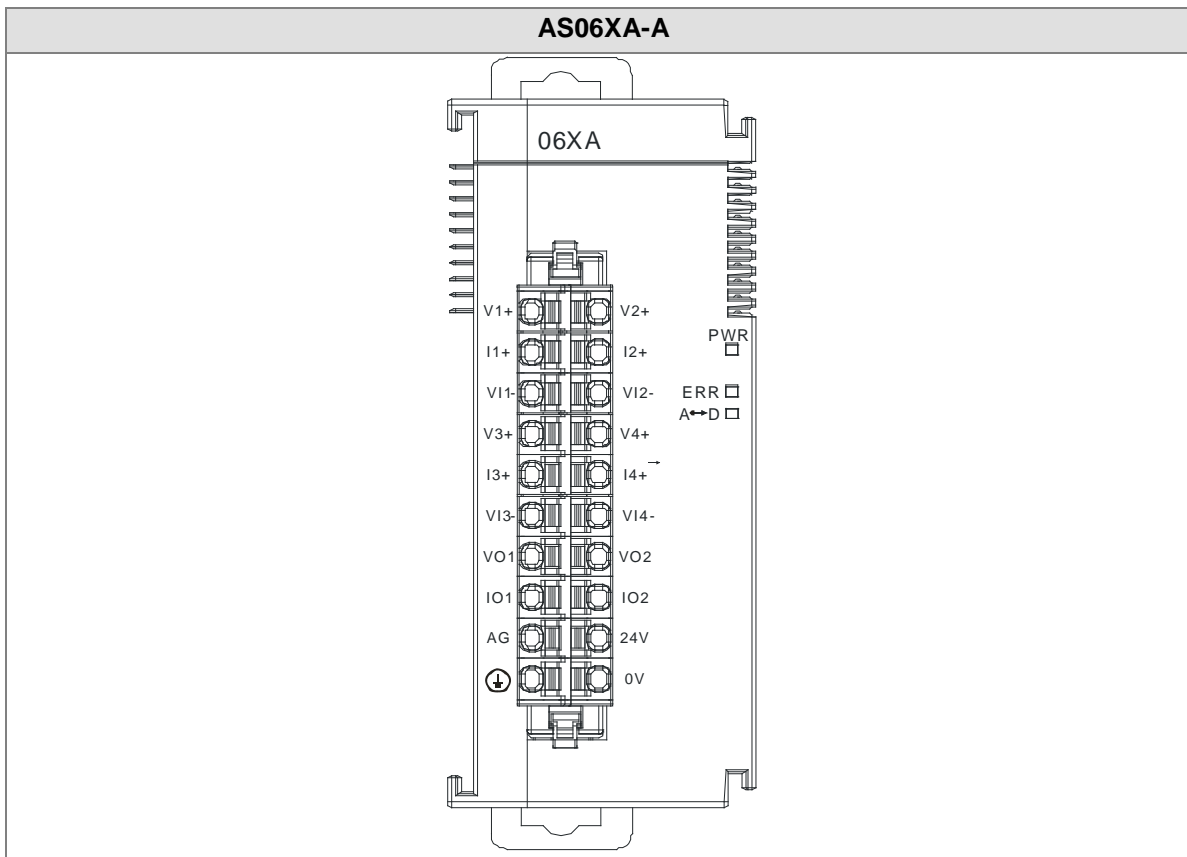

4.2.4 Control Registers

CR#	Name	Description	Defaults
0	Format setup	0: integer format 1: floating point format	0
1	Input channel 1 mode setup	0: closed 1: -10V~10V (default)	1
2	Input channel 2 mode setup	2: 0~10V 3: -5~5V	
3	Input channel 3 mode setup	4: 0~5V 5: 1~5V	
4	Input channel 4 mode setup	6: 0mA~20mA 7: 4mA~20mA 8: -20mA~20mA	
5	Input channel 1 offset	Setting range: -32768~32767	0
6	Input channel 2 offset		
7	Input channel 3 offset		
8	Input channel 4 offset		
9	Input channel 1 gain	Setting range: -32768~32767	1000
10	Input channel 2 gain		
11	Input channel 3 gain		
12	Input channel 4 gain		
13	Input channel 1 average times	Setting range: 1~100	10
14	Input channel 2 average times		
15	Input channel 3 average times		
16	Input channel 4 average times		
17	Input channel 1 filter average percentage	Setting range: 0~3, unit: $\pm 10\%$	1
18	Input channel 2 filter average percentage		

CR#	Name	Description	Defaults
19	Input channel 3 filter average percentage		
20	Input channel 4 filter average percentage		
21	Input channel sampling cycle (sampling/integration time)	0 : 2ms 1 : 4ms 2 : 10ms 3 : 15ms 4 : 20ms 5 : 30ms 6 : 40ms 7 : 50ms 8 : 60ms 9 : 70ms 10 : 80ms 11 : 90ms 12 : 100ms	0
22	Input channel alarm setup	0: open channel alarm 1: close channel alarm bit0: Channel 1 bit1: Channel 2 bit2: Channel 3 bit3: Channel 4 0: warning 1: alarm bit8: Error occurs in the module power bit9: Error occurs in the module hardware bit10: Error occurs in calibration	
23	Output channel 1 mode setup	0: closed 1: -10V~10V (default)	1
24	Output channel 2 mode setup	2: 0~10V 3: -5~5V	

CR#	Name	Description	Defaults
		4: 0~5V 5: 1~5V 6: 0mA~20mA 7: 4mA~20mA	
25	Output channel 1 offset	Setting range: -32768~32767	0
26	Output channel 2 offset		
27	Output channel 1 gain	Setting range: -32768~32767	1000
28	Output channel 2 gain		
29	Retaining an output sent by channel 1	0: when the PLC stops, the value of the analog output will be reset to 0.	0
30	Retaining an output sent by channel 2	1: when the PLC stops, the value of the analog output will be retained.	
31	Refreshing the time for an output sent by channel 1	Setting range: 10~3200 (100ms~32s); unit: 10ms For a value less than 10, it will be seen as 0. For a value bigger than 3200, the value will be seen as 3200. When the value is 0, this function is disabled.	0
32	Refreshing the time for an output sent by channel 2		
33	The minimum scale range	The analog input mode of a channel has a corresponding digital range; that is, an analog range corresponds to a digital range. For example, if the analog range is -10 V~10 V and the digital range is -10.0~10.0, the analog values -10 V~10 V correspond to the digital values -10.0~10.0. If the analog input mode of a channel is 4mA~20mA, it means the minimum scale range is 4mA and the maximum scale range is 20mA. When the format is integer format, the scale range is invalid.	-10
34	for input channel 1		
35	The minimum scale range		-10
36	for input channel 2		
37	The minimum scale range		-10
38	for input channel 3		
39	The minimum scale range		-10
40	for input channel 4		
41	The minimum scale range		-10
42	for output channel 1		
43	The minimum scale range		-10
44	for output channel 2		
45	The maximum scale range		10
46	for input channel 1		
47	The maximum scale range		10
48	for input channel 2		

CR#	Name	Description	Defaults
49	The maximum scale range		10
50	for input channel 3		
51	The maximum scale range		10
52	for input channel 4		
53	The maximum scale range		10
54	for output channel 1		
55	The maximum scale range		10
56	for output channel 2		
201	Instruction set	<p>Instructions for peak values</p> <p>16#0101: record the peak value again for channel 1</p> <p>16#0102: record the peak value again for channel 2</p> <p>16#0104: record the peak value again for channel 3</p> <p>16#0108: record the peak value again for channel 4</p> <p>16#010F: record the peak value again for channel 1~4</p> <p>16#0201: enable to record for channel 1</p> <p>16#0202: enable to record for channel 2</p> <p>16#0204: enable to record for channel 3</p> <p>16#0208: enable to record for channel 4</p> <p>16#020F: enable to record for channels 1~4</p> <p>16#0211: disable to record for channel 1</p> <p>16#0212: disable to record for channel 2</p> <p>16#0214: disable to record for channel 3</p> <p>16#0218: disable to record for channel 4</p> <p>16#021F: disable to record for channel 1~4</p> <p>16#0502: restore to its default settings</p>	0
210	The maximum peak value for channel 1	Integer format; the maximum peak value for analog inputs	-
211	The maximum peak value for channel 2		-
212	The maximum peak value for channel 3		-
213	The maximum peak value for channel 4		-

CR#	Name	Description	Defaults
214	The minimum peak value for channel 1	Integer format; the minimum peak value for analog inputs	0
215	The minimum peak value for channel 2		0
216	The minimum peak value for channel 3		0
217	The minimum peak value for channel 4		0
222	The time to record for channel 1	Unit: 10ms, setting range 1~100 Setting the time to record the digital value for the channels	1
223	The time to record for channel 2		1
224	The time to record for channel 3		1
225	The time to record for channel 4		1
240	The number of records for channel 1	Range: 0~500, display the current records	0
241	The number of records for channel 2		0
242	The number of records for channel 3		0
243	The number of records for channel 4		0
4000~4499	Records for channel 1	500 records for channel 1	--
4500~4999	Records for channel 2	500 records for channel 2	--
5000~5499	Records for channel 3	500 records for channel 3	--
5500~5999	Records for channel 4	500 records for channel 4	--

4.2.5 Functions

HWCONFIG, built-in utility software in ISPSOft, can be used to set a module. Users can set modes and parameters by means of HWCONFIG.

● Analog input

Item	Function	Description
1	Enabling/Disabling a channel	1. Users can enable or disable a channel. 2. If a channel is disabled, the total conversion time is decreased.
2	Calibration	Users can calibrate a linear curve.
3	Average	Conversion values are averaged and filtered.
4	Disconnection detection	Only if the analog rang is 4 mA~20 mA or 1 V~5 V does the disconnection detection function.
5	Channel detec and alarm	If an input signal exceeds a range of inputs which can be received by hardware, the module will give an alarm or a warning. This function can be disabled.
6	The limit detections for channels	Saving the maximum/minimum values for channles
7	Records for channales	Saving the analog curves for channels
8	Scale range	When the format is floating-point numbers, the scale range can be set.

1. Enabling/Disabling a channel

An analog signal is converted into a digital signal at a speed of 2ms a channel. The total conversion time is 2ms X (the number of channels). If a channel is not used, users can disable it to decrease the total conversion time.

2. Calibration

- To make a curve meet actual needs, users can calibrate the curve by changing an offset and a gain. A calibration range depends on a range of inputs which can be received by hardware. The formula is as below.

$$Output = \frac{(Input \times Gain)}{1000} + Offset$$

Example:

The inputs received by a channel are voltages in the range of -10.0 V to +10.0 V. The gain is 1000, and the offset is 0. The corresponding value for the original signal -10.0 V to +10.0 V is -32000~32000. When using the offset -100, the calibrated value for the original signal -10.0 V to +10.0 V is -31900~32100. When the input voltage is 0 V, the digital value will be -100. When the input voltage is 10.0 V, the digital value is 32100.

Gain = 1000, Offset = -100

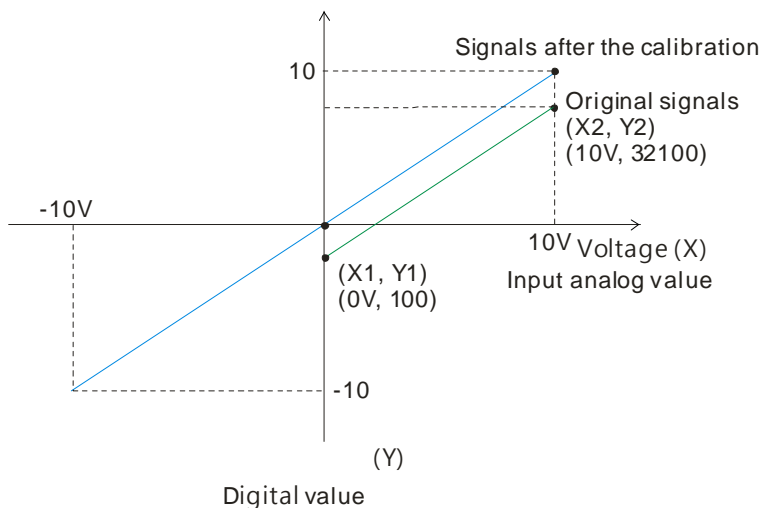

3. Average

The average value can be set in the range of 1~100. It is a steady value obtained from the sum of the read values. However, due to unavoidable external factors, the read values may be an acute pulse, resulting in fierce changes in the average value. The filtering function thus exclude the read value that is an acute pulse from the sum-up and equalization, so the average value obtained will not be affected by the acute read value. The filter percentage is set in the range of 0~3, and the unit is 10%. Setting 0 in the filter range, the system will sum up all the read values and equalize to obtain the average value; setting 1 in the filter range, the system will exclude the 10% of the maximum and minimum value and then equalize to obtain the average value.

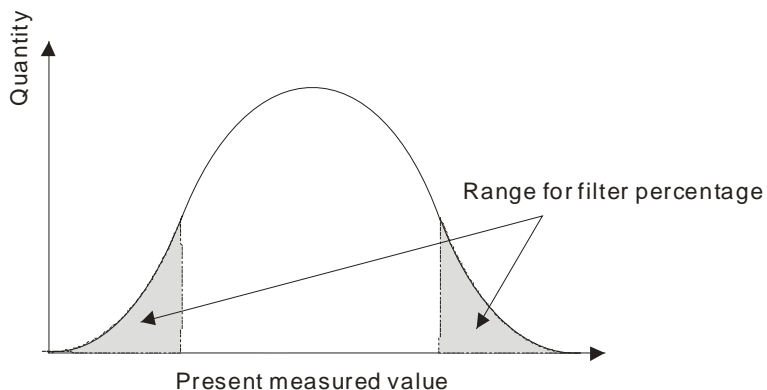

4. Disconnection detection

Only if the analog rang is 4 mA~20 mA or 1 V~5 V does the disconnection detection function. If a module which can receive inputs ranging from 4 mA to 20 mA or from 1 V to 5V is disconnected, an input signal will exceed the range of inputs which can be received by the hardware, and the module will give an alarm or a warning.

5. Channel detection

If an input signal exceeds a range of inputs which can be received by hardware, an error message appears. This function can be disabled and then the module will not send an alarm or warning when the input signal exceeding the range of inputs.

6. The limit detections for channels

Saving the maximum/minimum values for channles and users can know the peak to peak value from the maximum/minimum values

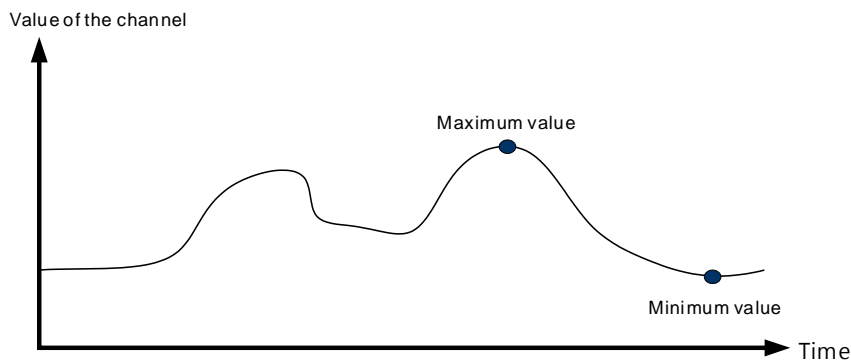

7. Records for channels

Record the input value of the cyclic sampling for each channel, up to 500 pieces can be recorded and the recording time is 10ms.

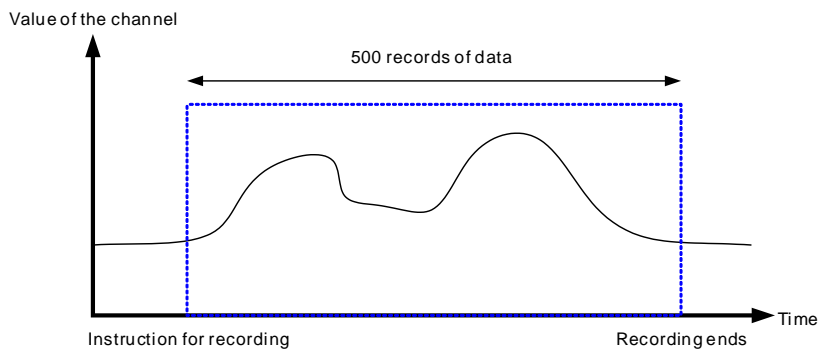

8. Scale range

When the format is floating-point numbers, the scale range can be set. The analog output mode of a channel has a corresponding digital range. Digital values correspond to analog outputs sent by a module. For example, if the analog range is -10 V~10 V, the digital range is -10.0~10.0 and the scale HSP is 10.0 and the scal LSP is -10.0. The digital values -10.0~10.0 correspond to the analog values -10 V~10 V as the example shown below.

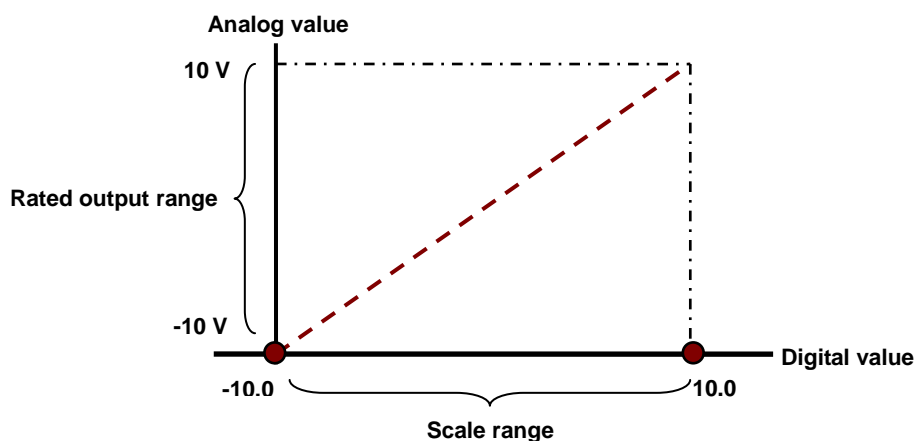

● Analog output

Item	Function	Description
1	Enabling/Disabling a channel	1. Users can enable or disable a channel. 2. If a channel is disabled, the total conversion time is decreased.
2	Calibration	Users can calibrate a linear curve.
3	Retaining an output	When a module stops running, a signal sent by the module is retained.
4	Refreshing time for an output	Refreshing the analog output value according to the value of the fixed slope
5	Scale range	When the format is floating-point numbers, the scale range can be set.

1. Enabling/Disabling a channel

An analog signal is converted into a digital signal at a speed of 2ms a channel. The total conversion time is 2ms X (the number of channels). If a channel is not used, users can disable it to decrease the total conversion time.

2. Calibration

- To make a curve meet actual needs, users can calibrate the curve by changing an offset and a gain. A calibration range depends on a range of inputs which can be received by hardware. The formula is as below.

$$Output = \frac{(Input \times Gain)}{1000} + Offset$$

Example:

The inputs received by a channel are voltages in the range of -10.0 V to +10.0 V. The gain is 1000, and the offset is 0. The corresponding value for the original signal -10.0 V to +10.0 V is -32000~32000. When using the offset 200 and the gain 1000, the calibrated vaule for the original signal -10.0 V to +10.0 V is -31800~32200.

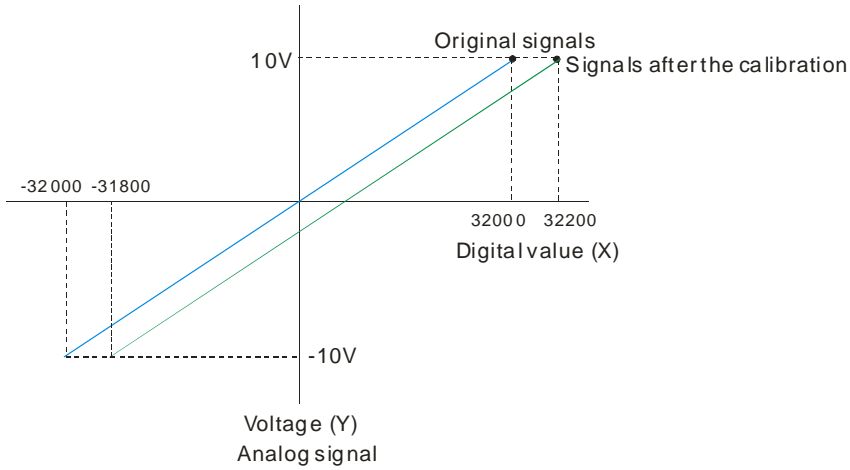

4

3. Retaining an output

When a module stops running, a signal sent by the module is retained.

The output is not retained:

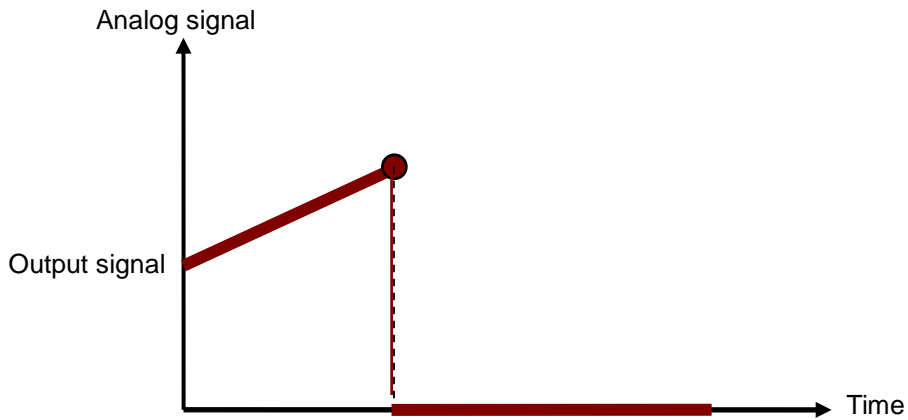

3. Refreshing time for an output

Users set the refreshing time for an output and the value of the slope (m) will be updated accordingly.

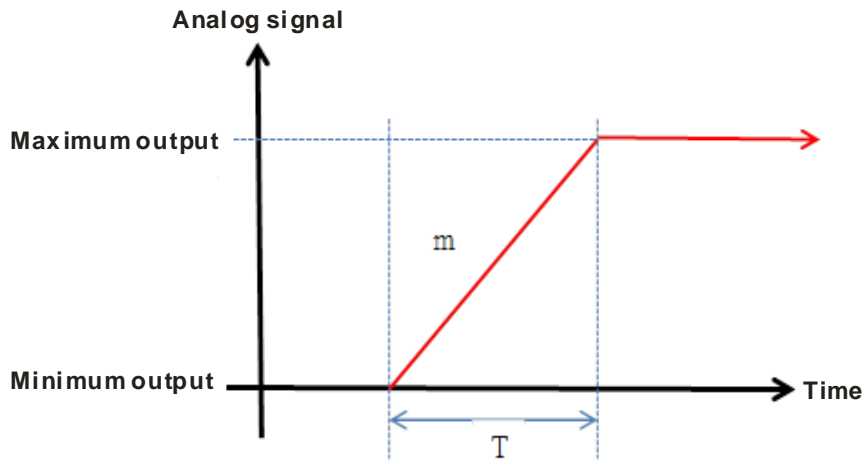

When the analog output signal changes, the value of the analog output will be updated according to the value set in the slope as the image shown below.

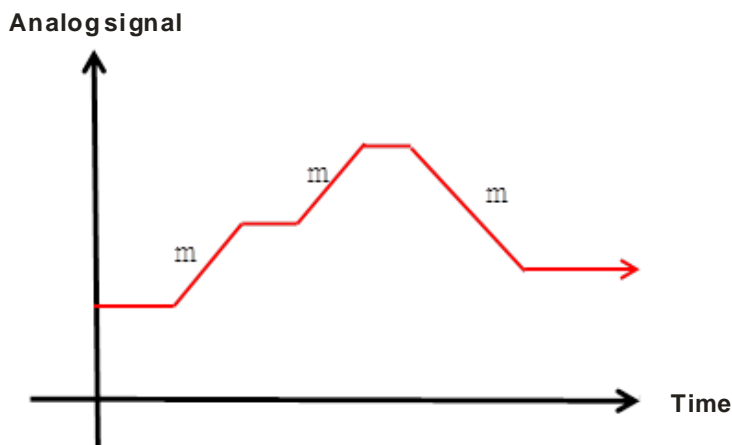

*The output conversion time and the input channel sampling cycle are the same.

4. Scale range

When the format is floating-point numbers, the scale range can be set. The analog output mode of a channel has a corresponding digital range. Digital values correspond to analog outputs sent by a module. For example, if the analog range is $-10\text{ V}\sim 10\text{ V}$, the digital range is $-10.0\sim 10.0$ and the scale HSP is 10.0 and the scal LSP is -10.0 . The digital values $-10.0\sim 10.0$ correspond to the analog values $-10\text{ V}\sim 10\text{ V}$ as the example shown below.

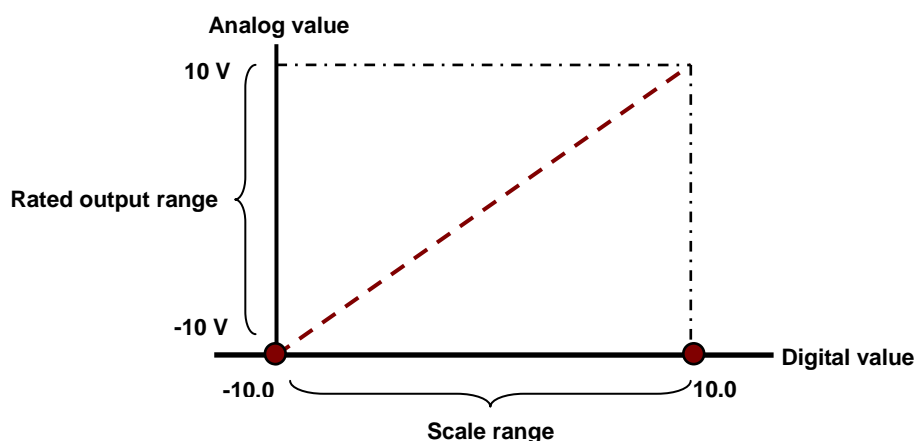

4.2.6 Wiring

● Precautions

In order to make the functions of an analog-to-digital module perfect and ensure the reliability of a system at the same time, external wiring which prevents noise is necessary. Before installing cables, users need to follow the precautions below.

- (1) To prevent a surge and induction, an AC cable and input signal cables which are connected to AS06XA-A must be separate cables.
- (2) A cable must not be installed near a main circuit, a high-voltage cable, or a cable connected to a load which is not a PLC. Besides, a cable must not be bound to a main circuit, a high-voltage cable, or a cable connected to a load which is not a PLC. Otherwise, effects that noise, induction, and a surge have will increase.
- (3) Please connect a shielded cable and a hermetically sealed cable with the ground separately.
- (4) Terminals with insulation sleeves can not be arranged as a terminal block. It is recommended that the terminals be covered with insulation tubes.
- (5) Please use single-core cables or twin-core cables in a diameter of 24 AWG~22 AWG and with less than 1mm pin-typed connectors. Only use copper conducting wires with a temperature of 60/75°C.

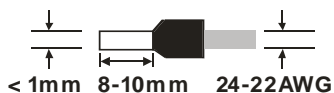

- (6) Two-wire connection/Three-wire connection/Four-wire connection:

- Two-wire connection/Three-wire connection (Passive transducer): A transducer and an analog input module are connected to a power circuit collectively.
- Four-wire connection (Active transducer): A transducer uses an independent power supply. It is not connected to the power circuit which is connected to an analog input module.

● External wiring

(1) AS06XA-A

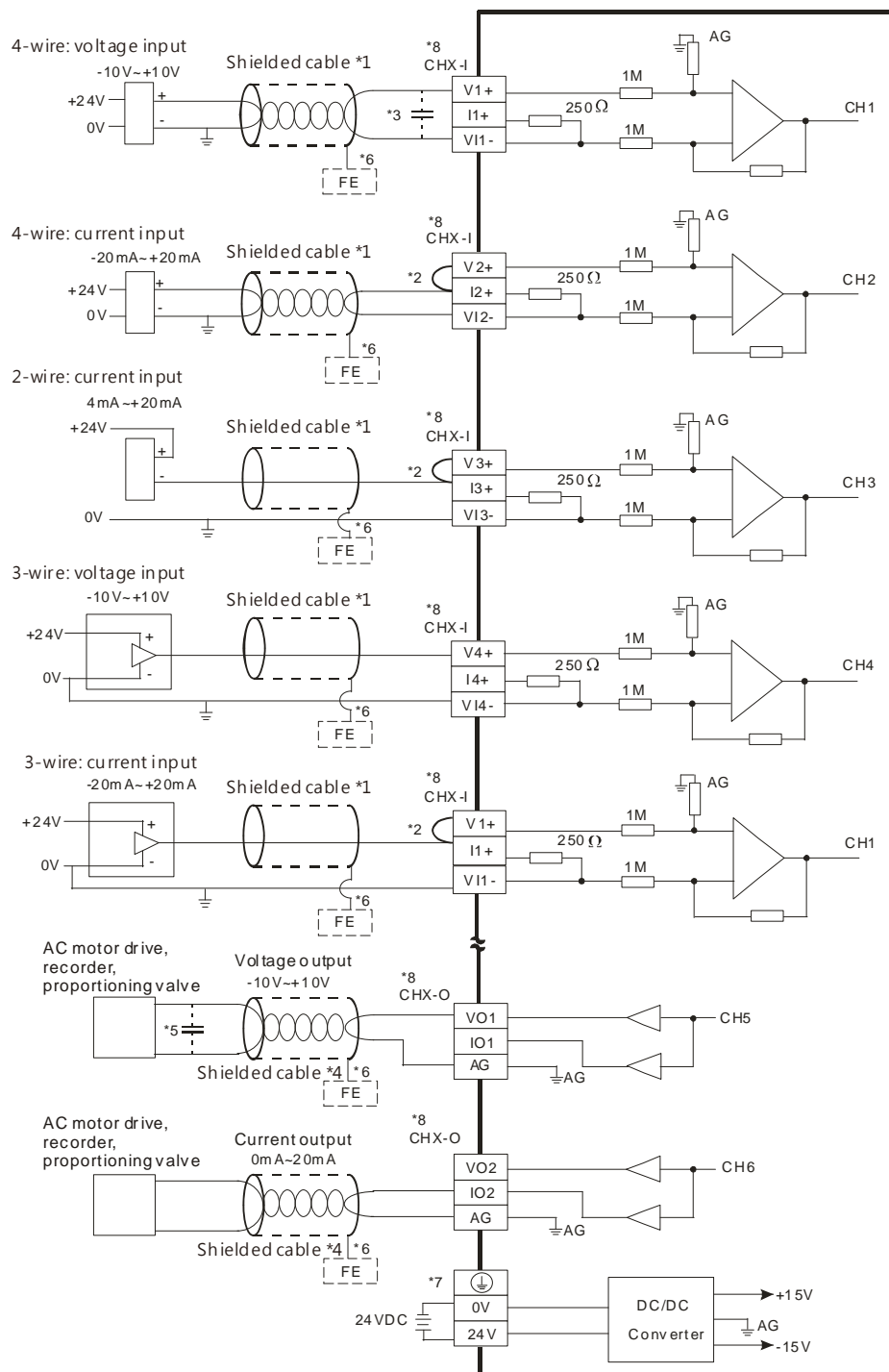

*1. Please use shielded cables to isolate the analog input signal cable from other power cables.

*2. If the module is connected to a current signal, the terminals Vn and In+ (n=1~4) must be short-circuited.

*3. If the ripple in the input voltage results in the noise interference with the wiring, please connect the module to the capacitor having a capacitance in the range of 0.1 μF to 0.47 μF with a working voltage of 25 V.

- *4. Please connect the shielded cable to the terminal FE.
- *5. If the ripple voltage of the input terminal of the load connected is large, and results in interference with the wiring, please connect the module to the capacitor having a capacitance in the range of 0.1 μF to 0.47 μF with a working voltage of 25 V.
- *6. Please connect the shielded cable to the terminal FE and to the ground terminal.
- *7. Please connect the terminal  to the ground terminal.
- *8. The wording "CHX-I" indicates that the 5 wiring methods listed above can be used for every input channel. The wording "CHX-O" indicates that the 2 wiring methods listed above can be used ofr every output channel.

4.2.7 LED Indicators

Number	Name	Description
1	RUN LED indicator	Operating status of the module ON: The module is running. OFF: The module stops running.
2	ERROR LED indicator	Error status of the module ON: A serious error occurs in the module. OFF: The module is normal. Blink: A slight error occurs in the module.
3	Digital to analog conversion indicator	Indicating the digital to analog conversion status Blinking: conversion is taking place OFF: stop conversion

4.3 HWCONFIG in ISPSOft

4.3.1 Initial Setting

- (1) Start ISPSOft, and then double-click **HWCONFIG**.

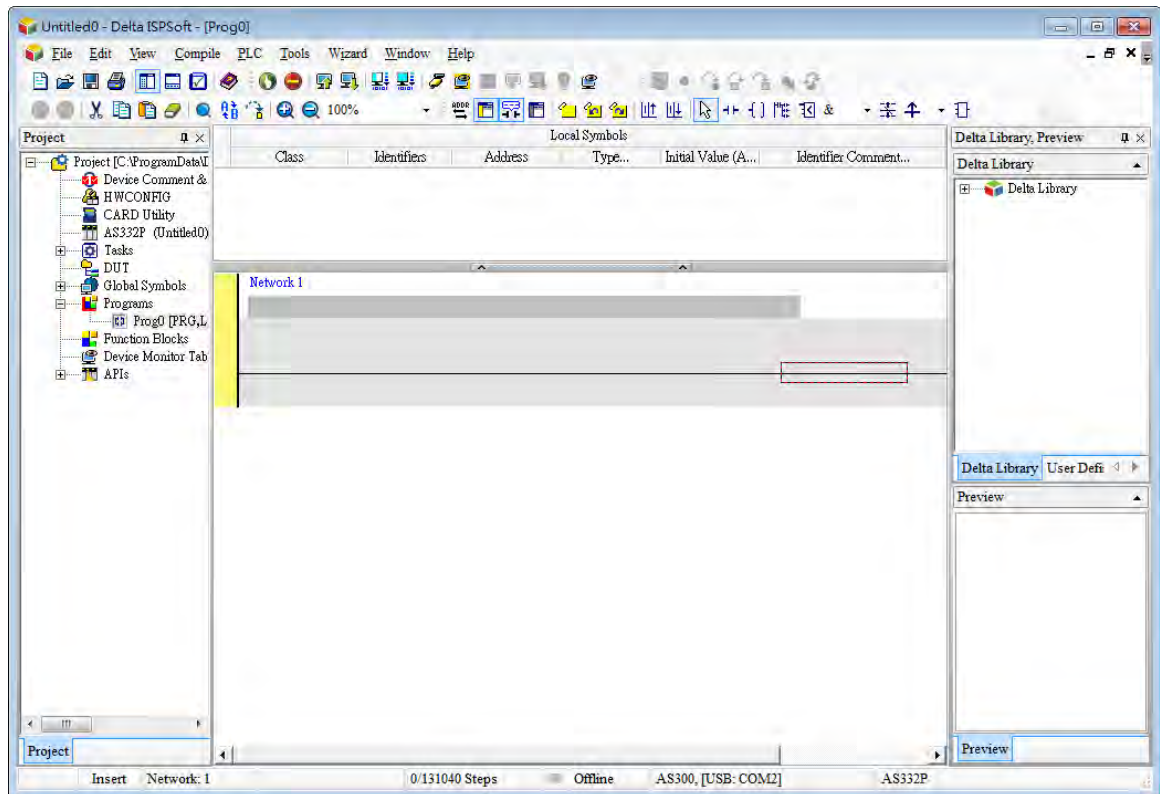

- (2) Selecting a module.

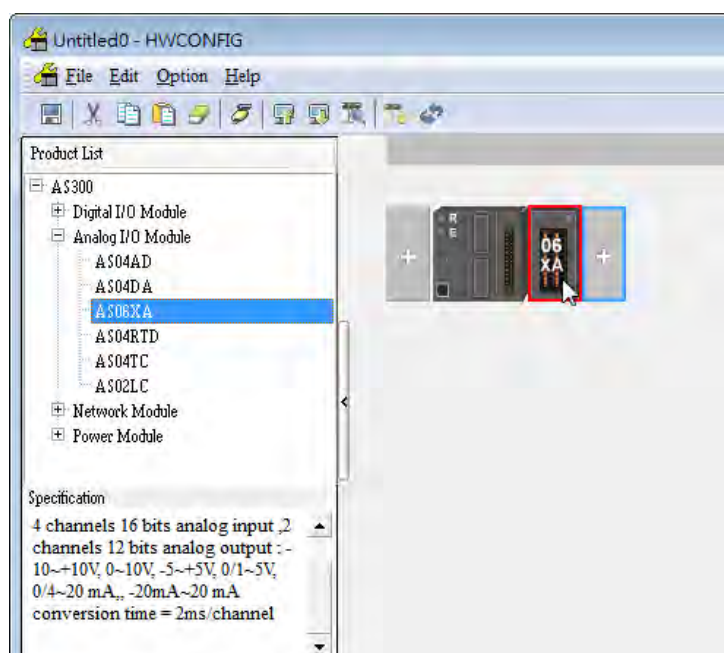

(3) Double-click the module to open the Device Setting page.

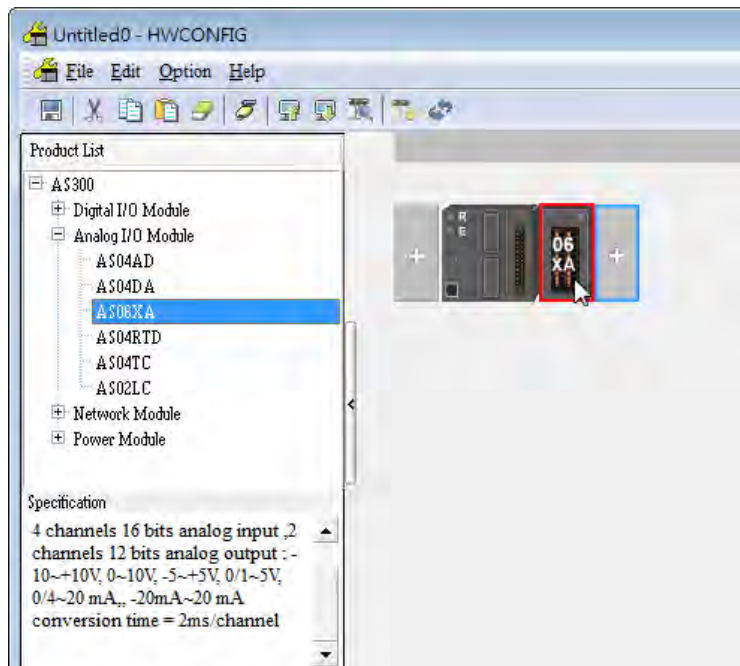

4

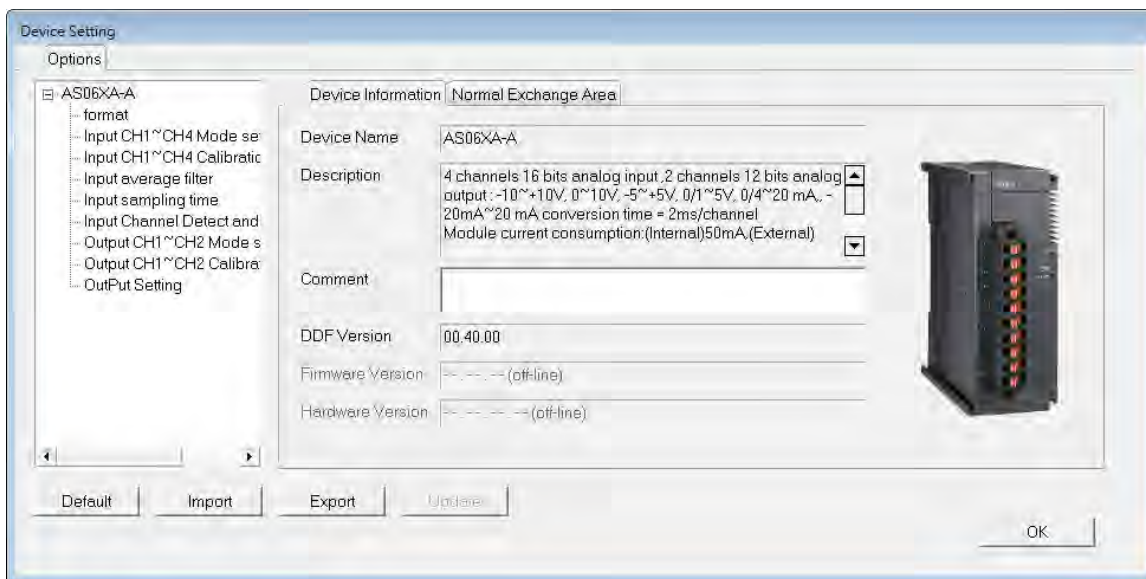

- (4) Set the parameters, and then click **OK**.

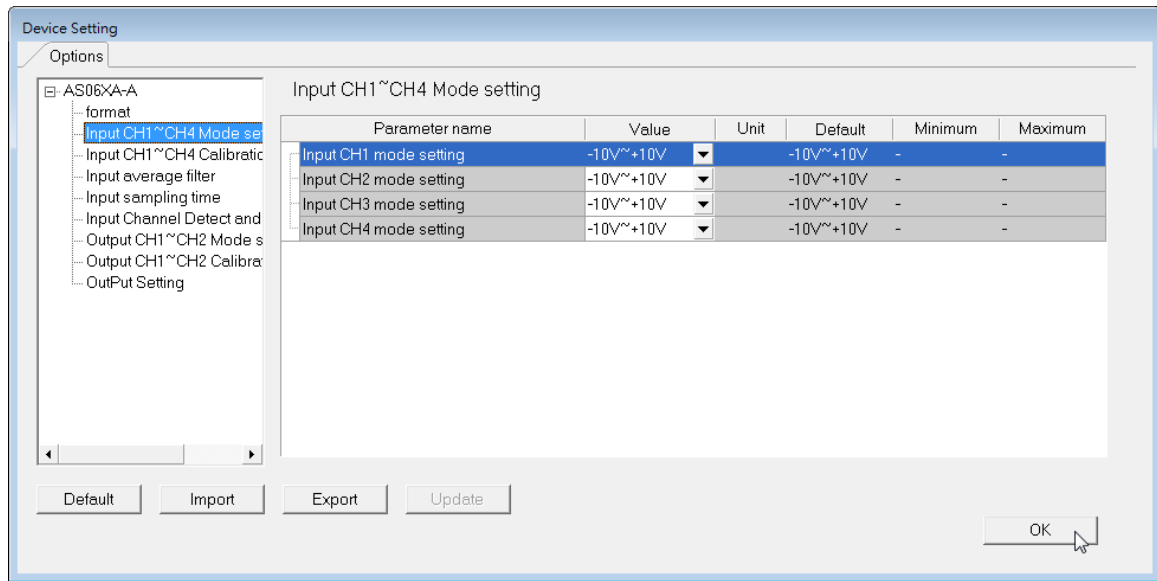

- (5) Click **Download** on the toolbar to download the parameters. (The parameters can not be downloaded when the CPU module runs.)

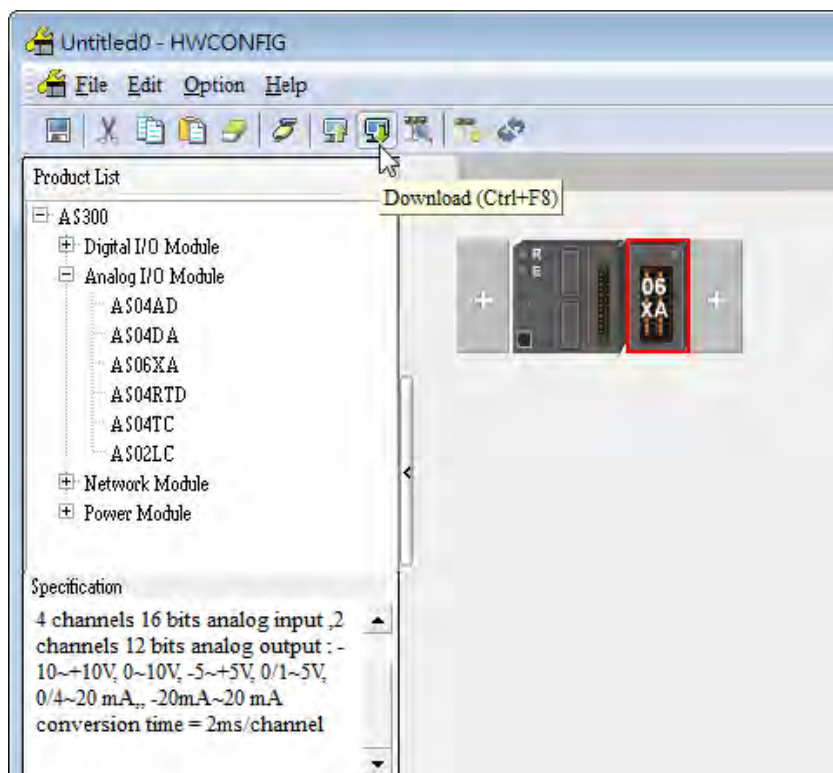

4.3.2 Checking the Version of a Module

- (1) On the **Option** menu, click **Online Mode**.

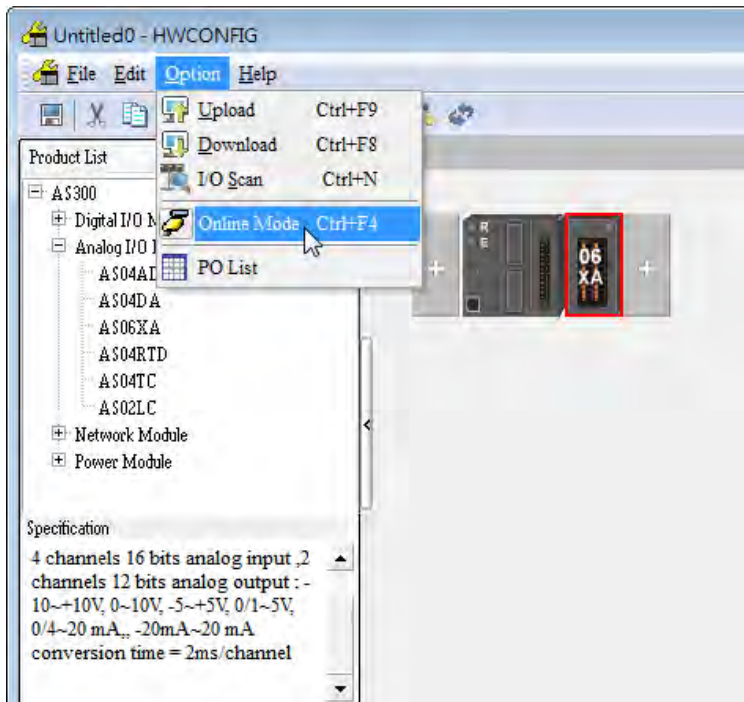

- (2) Double-click the module to see the Device Setting page. The version of the firmware and that of the hardware are displayed.

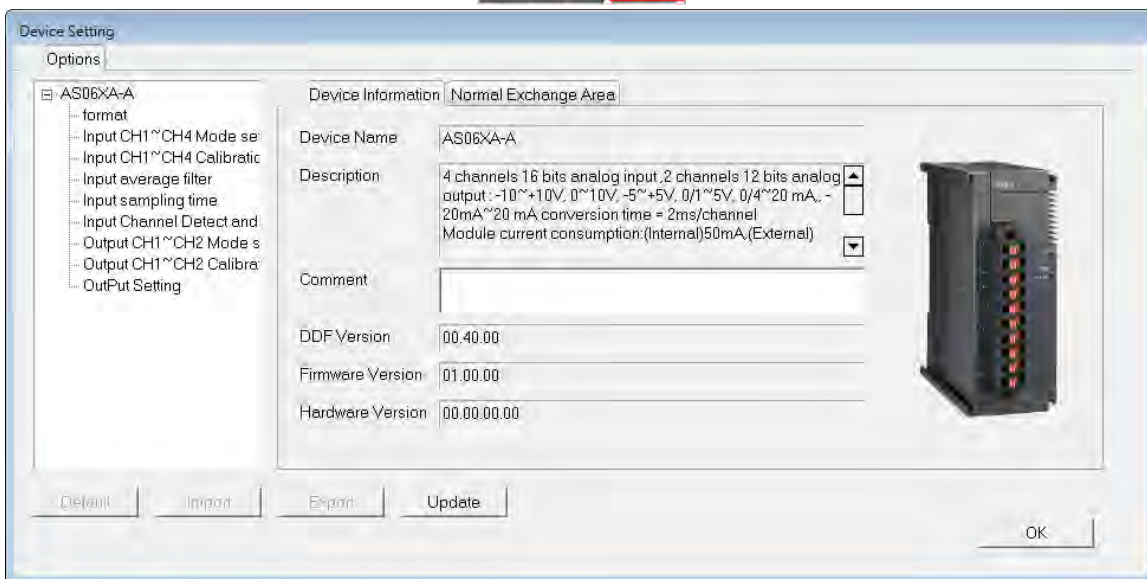

4.3.3 Online Mode

(1) Click **Online Mode** on the toolbar.

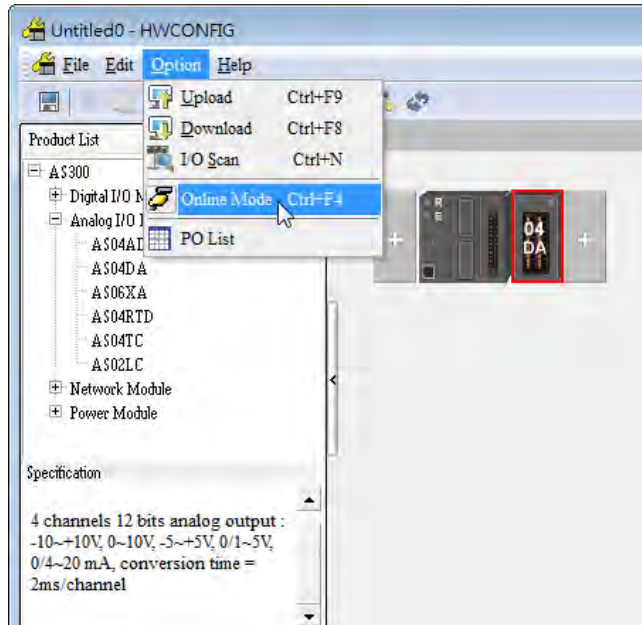

(2) Right-click the module.

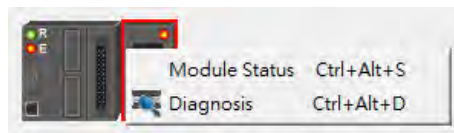

(3) The module status can be shown.

Channel	Value (32 bits)	Data Type
Error code	6145	DECIMAL
CH1 Input	0	DECIMAL
CH2 Input	0	DECIMAL
CH3 Input	0	DECIMAL
CH4 Input	0	DECIMAL
CH1 Output	0	DECIMAL
CH2 Output	0	DECIMAL

4.3.4 Importing/Exporting a Parameter File

(1) After **Export** is clicked, the parameters will be saved as a CSV file (.csv).

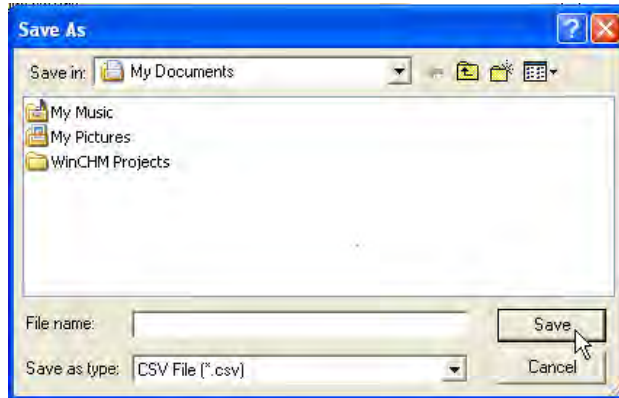

(2) Click **Import**, and then select the CSV file.

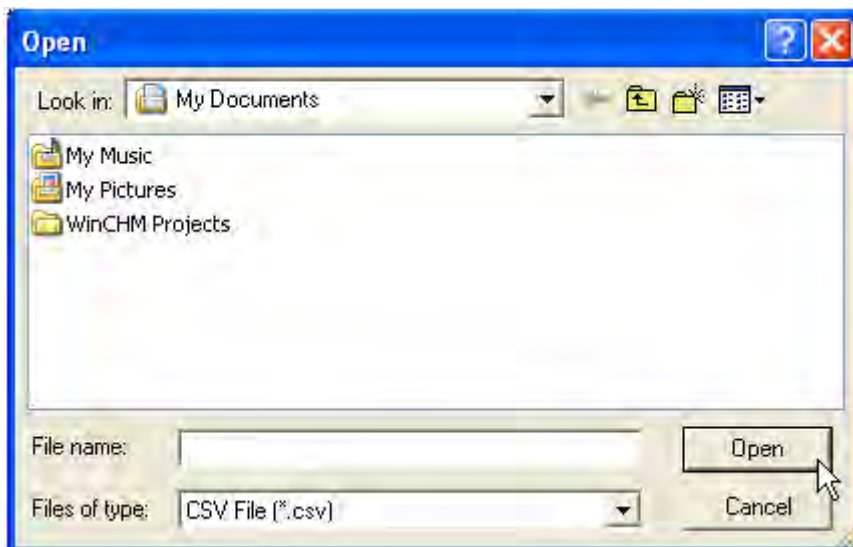

4.3.5 Parameters

(1) The input modes of the channels

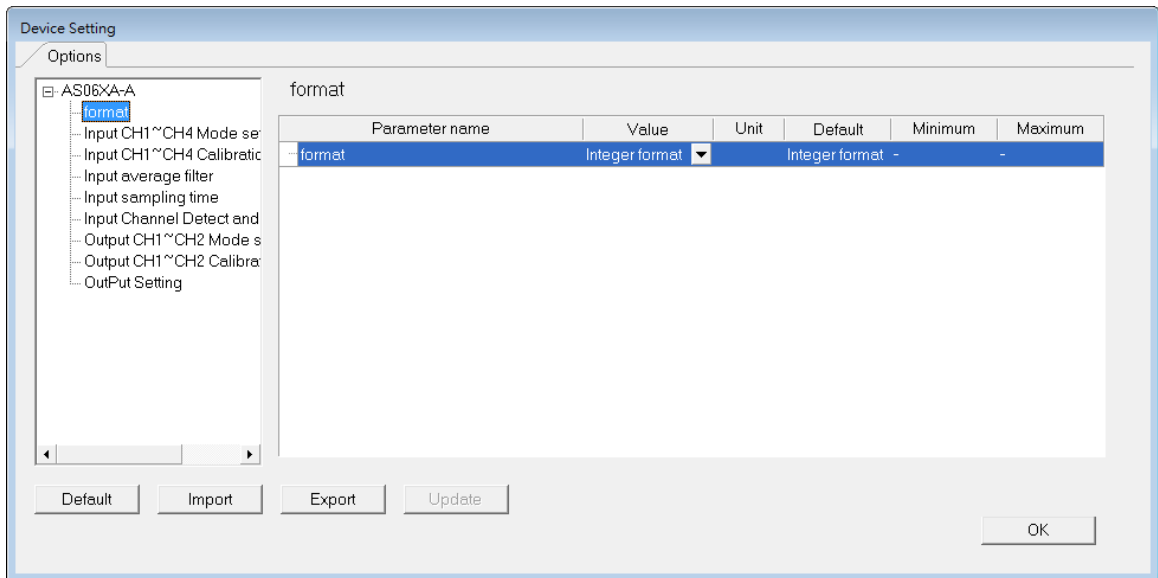

(2) Input CH1~CH4 Mode settings

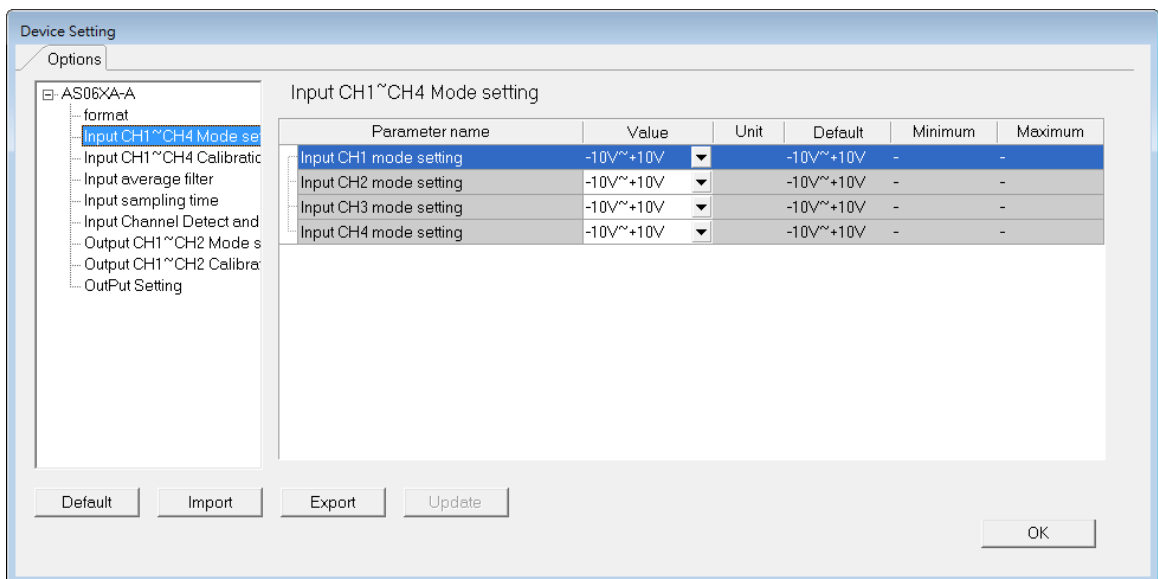

(3) Input CH1~CH4 calibration

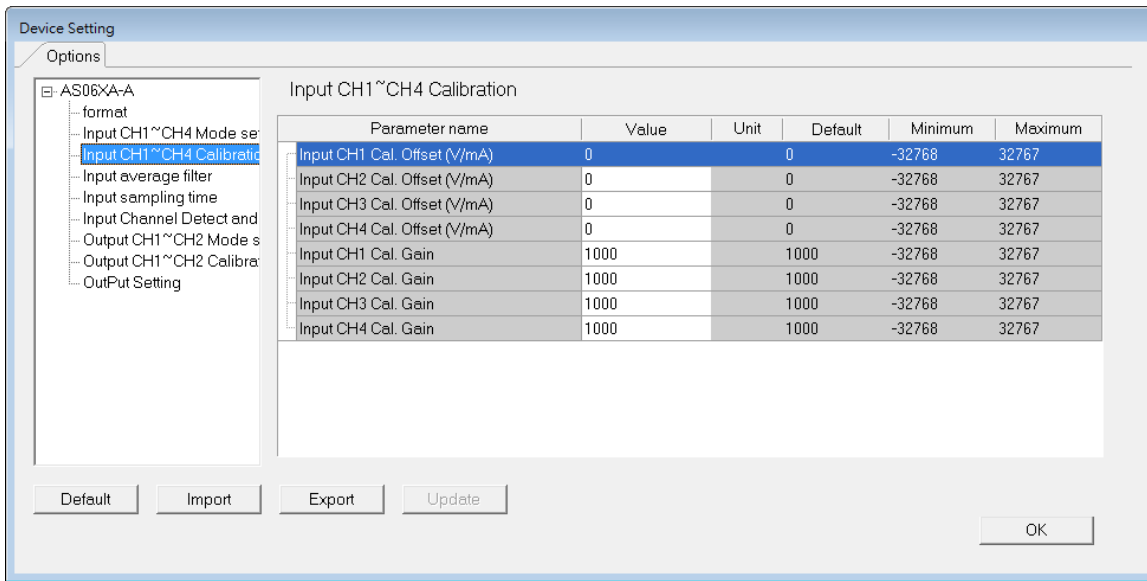

4

(4) Input average filter

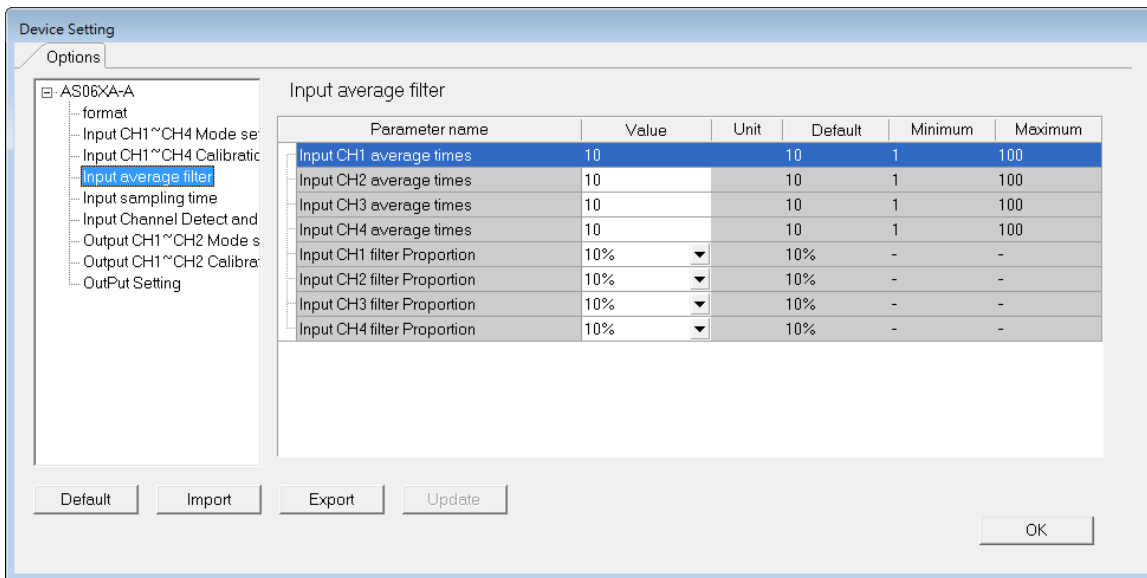

(5) Input sampling time

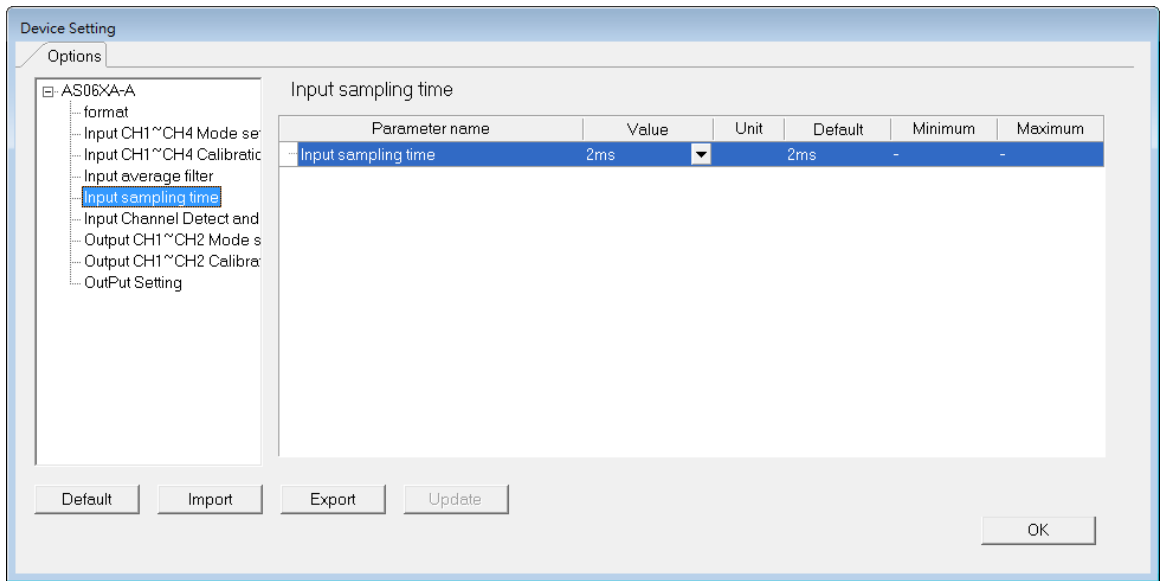

(6) Input channel detect and alarm settings

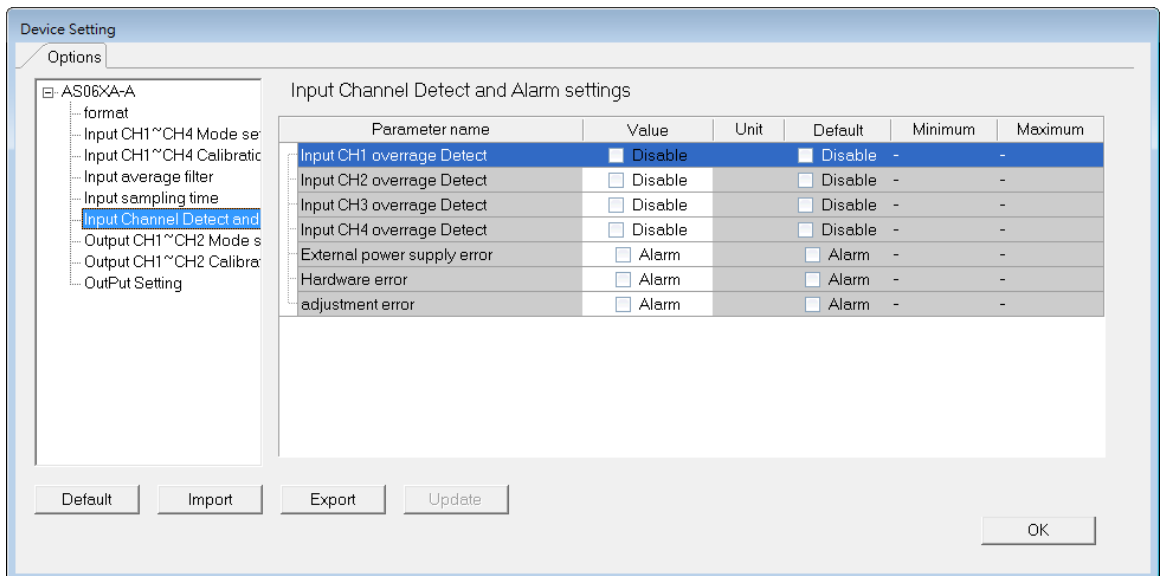

(7) Output CH1~CH2 mode settings

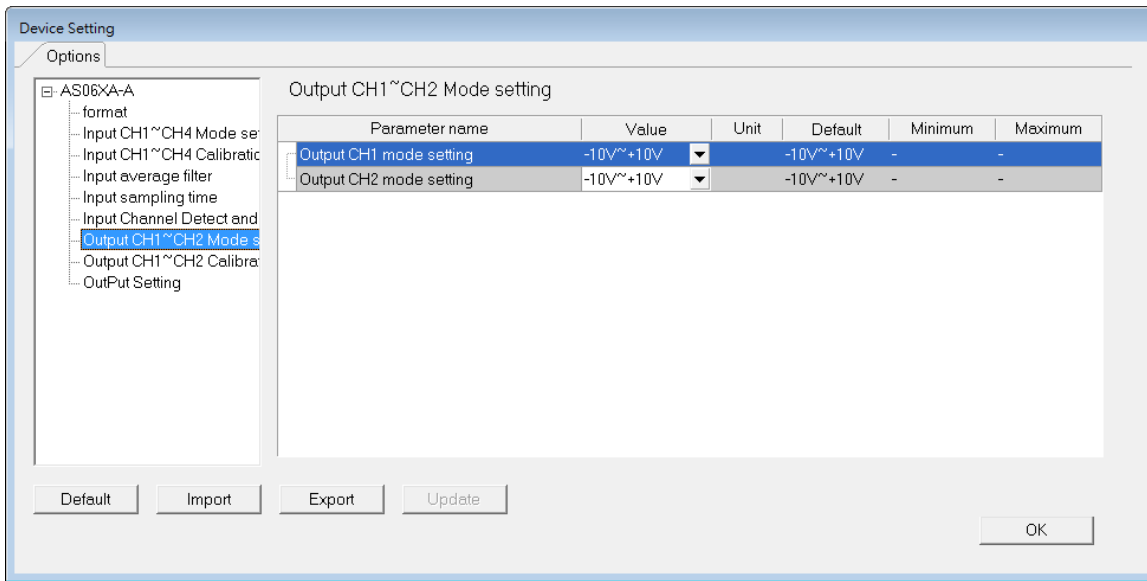

(8) Output CH1~2 calibration

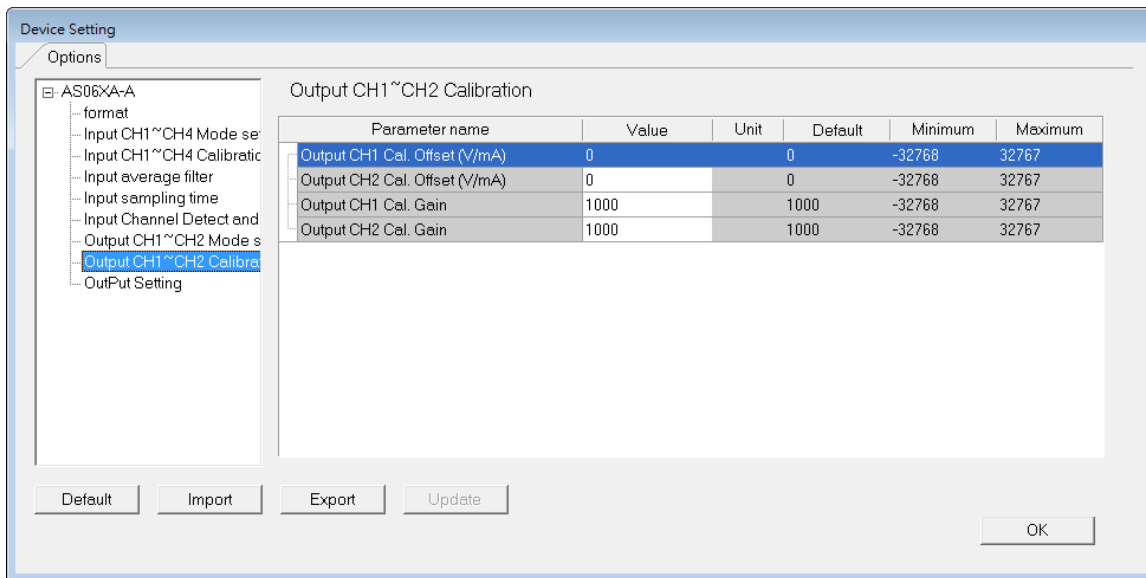

(9) Output Setting

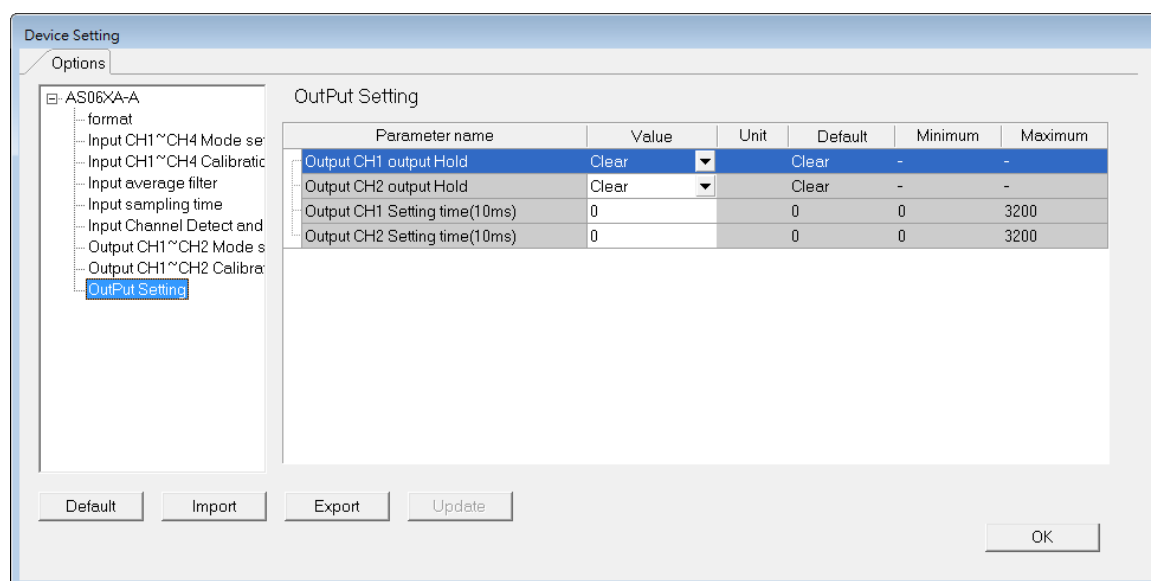

4.4 Troubleshooting

4.4.1 Error Codes

Error Code	Description	A↔D LED indicator	ERROR LED indicator
16#1605	Hardware failure	OFF	ON
16#1607	The external voltage is abnormal.	OFF	ON
16#1608	The factory calibration is abnormal.	OFF	ON
16#1801	The external voltage is abnormal.	OFF	Blinking
16#1802	Hardware failure	OFF	Blinking
16#1804	The factory calibration is abnormal.	OFF	Blinking
16#1808	The signal received by channel 1 exceeds the range of inputs which can be received by the hardware.	Run: blinking Stop: OFF	Blinking
16#1809	The signal received by channel 2 exceeds the range of inputs which can be received by the hardware.		
16#180A	The signal received by channel 3 exceeds the range of inputs which can be received by the hardware.		
16#180B	The signal received by channel 4 exceeds the range of inputs which can be received by the hardware.		

4.4.2 Troubleshooting Procedure

Description	Procedure
The external voltage is abnormal.	Check whether the external 24 V power supply to the module is normal.
Hardware failure	Return the module to the factory for repair.
Internal error The factory correction is abnormal.	Please contact the factory.
The signal received by channel 1 exceeds the range of inputs which can be received by the hardware.	Check the signal received by channel 1
The signal received by channel 2 exceeds the range of inputs which can be received by the hardware.	Check the signal received by channel 2.
The signal received by channel 3 exceeds the range of inputs which can be received by the hardware.	Check the signal received by channel 3.
The signal received by channel 4 exceeds the range of inputs which can be received by the hardware.	Check the signal received by channel 4.

Chapter 5 Temperature Measurement Module AS04RTD

Table of Contents

5.1 Overview	5-2
5.1.1 Characteristics.....	5-2
5.1.2 Characteristics.....	5-2
5.2 Specifications and Functions.....	5-3
5.2.1 Specifications	5-3
5.2.2 Profile.....	5-4
5.2.3 Arrangement of Terminals.....	5-5
5.2.4 Control Registers	5-6
5.2.5 Functions.....	5-9
5.2.6 Control Mode.....	5-14
5.2.7 Wiring	5-18
5.2.8 LED Indicators	5-20
5.2 HWCONFIG in ISPSOft.....	5-21
5.3.1 Initial Setting	5-21
5.3.2 Checking the Version of a Module.....	5-24
5.3.3 Online Mode	5-25
5.3.4 Importing/Exporting a Parameter File	5-26
5.3.5 Parameters	5-27
5.4 Troubleshooting.....	5-30
5.4.1 Error Codes	5-30
5.4.2 Troubleshooting Procedure	5-31
5.4.3 State of the Conneciton	5-31

5.1 Overview

5.1.1 Characteristics

The specifications for a temperature measurement module, the operation, and the programming are described in this section. AS04RTD is a temperature measurement module. It converts the temperatures received from its four thermocouples into digital signals. Users can select the degree Celsius or the degree Fahrenheit as a unit of measurement for temperature.

5.1.2 Characteristics

(1) **A sensor is selected according to practical application.**

Pt100/Ni100/Pt1000/Ni1000/JPt100/LG-Ni1000/Cu50/Cu100/0~300Ω/0~3000Ω sensor

(2) **High-speed conversion**

Two-wire/Three-wire configuration: 200 ms/channel

(3) **High accuracy**

Conversion accuracy: The error is $\pm 0.1\%$ of an input. (The ambient temperature is $25 \pm 5^\circ\text{C}$.)

(4) **Disconnection detection**

When a sensor is disconnected, AS04RTD gives an alarm or a warning.

(5) **PID control**

An object can be maintained at a desired temperature through a PID control action.

(6) **A module can be set by means of utility software.**

HWCONFIG is built-in utility software in ISPSOFT. Users can set modes and parameters in HWCONFIG to complete hardware configuration without spending time writing a program to set registers corresponding to functions.

5.2 Specifications and Functions

5.2.1 Specifications

- **Electrical specifications**

Number of analog inputs	4	
Applicable sensor	2-WIRE & 3-WIRE Pt100/Ni100/Pt1000/Ni1000/ JPt100/LG-Ni1000/Cu50/Cu100/0~300Ω/0~3000Ω Pt100 : DIN 43760-1980 JIS C1604-1989 ; 100Ω 3850 PPM/°C Pt1000 : DIN EN60751 ; 1 kΩ 3850 PPM/°C Ni100/Ni1000 : DIN 43760 JPt100 : JIS C1604-1989 LG-Ni1000 Cu50/Cu100	
Supply voltage	24 V DC (20.4 V DC~28.8 V DC) (-15%~+20%)	
Connector type	Removable terminal block	
Overall accuracy	Pt100/Ni100/Pt1000/Ni1000/JPt100	25°C/77°F: The error allowed is $\pm 0.1\%$ of full scale. -20~60°C/-4~140°F: The error allowed is $\pm 0.5\%$ of full scale.
	LG-Ni1000	25°C/77°F: The error allowed is $\pm 0.1\%$ of full scale.
	Cu50	25°C/77°F: The error allowed is $\pm 4\%$ of full scale.
	Cu100	25°C/77°F: The error allowed is $\pm 2\%$ of full scale.
Conversion time	Two-wire/Three-wire configuration: 200 ms/channel	
Isolation	An analog circuit is isolated from a digital circuit by a digital integrated circuit/an optocoupler, and the analog channels are isolated from one another by optocouplers. Isolation between a digital circuit and the ground: 500 V DC Isolation between an analog circuit and the ground: 500 V DC Isolation between an analog circuit and the digital circuit: 500 V DC Isolation between the 24 V DC and the ground: 500 V DC	

● Functional specifications

Analog-to-digital conversion	Centigrade (°C)	Fahrenheit (°F)	Input impedance
Rated input range	Pt100 : -180°C~800°C Ni100 : -80°C~170°C Pt1000 : -180°C~800°C Ni1000 : -80°C~170°C JPt100 : -180°C~500°C LG-Ni100 : -50°C~180°C Cu50 : -50°C~150°C Cu100 : -50°C~150°C	Pt100 : -292°F~1,472°F Ni100 : -112°F~338°F Pt1000 : -292°F~1,472°F Ni1000 : -112°F~338°F JPt100 : -112°F~338°F LG-Ni100 : -58°F~356°F Cu50 : -58°F~302°F Cu100 : -58°F~302°F	0~300Ω 0~3000Ω
Average function	Range: 1~100		
Self-diagnosis	Disconnection detection		

5.2.2 Profile

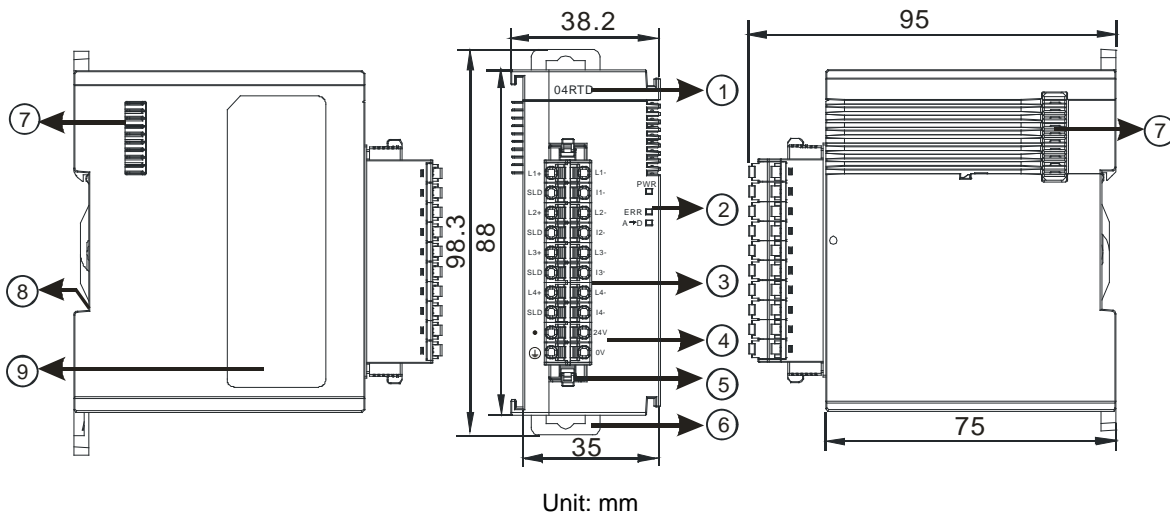

Number	Name	Description
1	Model name	Model name of the module
2	RUN LED indicator	Operating status of the module ON: The module is running. OFF: The module stops running.
	ERROR LED indicator	Error status of the module ON: A serious error occurs in the module. OFF: The module is normal. Blink: A slight error occurs in the module.

Number	Name	Description
	Digital to analog conversion indicator	Indicating the digital to analog conversion status Blinking: conversion is taking place OFF: stop conversion
3	Removable terminal block	The inputs are connected to transducers. The outputs are connected to loads which will be driven.
4	Arrangement of the input/output terminals	Arrangement of the terminals
5	Clip	Removing the terminal block
6	DIN rail clip	Securing the module onto the DIN rail
7	Module connecting set	Connecting the modules
8	Ground clip	

5.2.3 Arrangement of Terminals

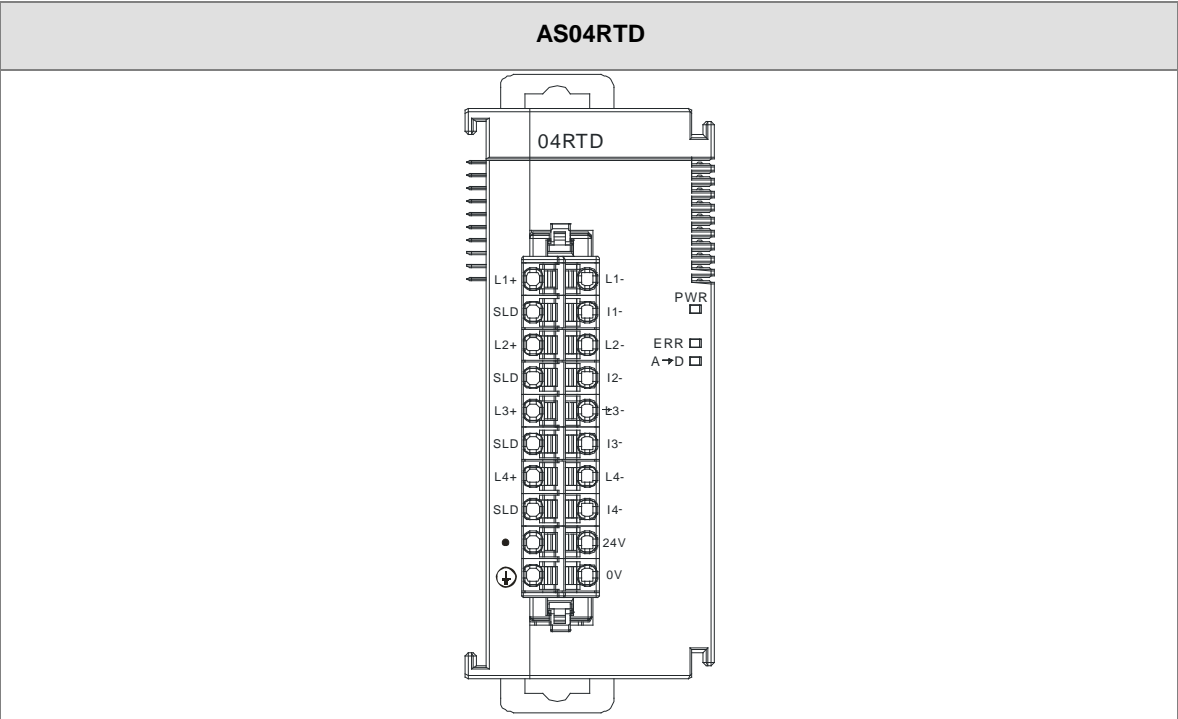

5.2.4 Control Registers

CR#	Name	Description	Defaults
0	Format setup	0: integer format 1: floating point format	0
1	Channel 1 mode setup	0: closed 1 : 0~300Ω (default)	1
2	Channel 2 mode setup	2 : 0~3000Ω 3 : Pt100	
3	Channel 3 mode setup	4 : JPt100 5 : Pt1000	
4	Channel 4 mode setup	6 : Ni100 7 : Ni1000	
		8 : LG-Ni1000 9 : Cu50 10 : Cu100	
5	Channel 1 offset	Setting range: -32768~32767	0
6	Channel 2 offset		
7	Channel 3 offset		
8	Channel 4 offset		
9	Channel 1 gain	Setting range: -32768~32767	1000
10	Channel 2 gain		
11	Channel 3 gain		
12	Channel 4 gain		
13	Channel 1 average times	Setting range: 1~100	10
14	Channel 2 average times		
15	Channel 3 average times		
16	Channel 4 average times		
17	Channel 1 filter average percentage	Setting range: 0~3, unit: ±10%	1
18	Channel 2 filter average percentage		
19	Channel 3 filter average percentage		
20	Channel 4 filter average percentage		

CR#	Name	Description	Defaults
21	Units of temperature	0: Fahrenheit 1: Celsius	0
22	Channel alarm setup	0: open channel alarm 1: close channel alarm bit0: Channel 1 bit1: Channel 2 bit2: Channel 3 bit3: Channel 4 0: warning 1: alarm bit8: Error occurs in the module power bit9: Error occurs in the module hardware bit10: Error occurs in calibration	0
201	Instruction set	16#0101: record the peak value again for channel 1 16#0102: record the peak value again for channel 2 16#0104: record the peak value again for channel 3 16#0108: record the peak value again for channel 4 16#010F: record the peak value again for channel 1~4 16#0201: enable to record for channel 1 16#0202: enable to record for channel 2 16#0204: enable to record for channel 3 16#0208: enable to record for channel 4 16#020F: enable to record for channels 1~4 16#0211: disable to record for channel 1 16#0212: disable to record for channel 2 16#0214: disable to record for channel 3 16#0218: disable to record for channel 4	0

CR#	Name	Description	Defaults
		16#021F: disable to record for channel 1~4 16#0502: restore to its default settings	
210	The maximum peak value for channel 1	Integer format; the maximum peak value for analog inputs	-
211	The maximum peak value for channel 2		-
212	The maximum peak value for channel 3		-
213	The maximum peak value for channel 4		-
214	The minimum peak value for channel 1	Integer format; the minimum peak value for analog inputs	-
215	The minimum peak value for channel 2		-
216	The minimum peak value for channel 3		-
217	The minimum peak value for channel 4		-
222	The time to record for channel 1	Unit: 10ms, setting range 1~100 Setting the time to record the digital value for the channels	1
223	The time to record for channel 2		1
224	The time to record for channel 3		1
225	The time to record for channel 4		1
240	The number of records for channel 1	Range: 0~500, display the current records	0
241	The number of records for channel 2		0
242	The number of records for channel 3		0
243	The number of records for channel 4		0
4000~ 4499	Records for channel 1	500 records for channel 1	--
4500~ 4999	Records for channel 2	500 records for channel 2	--
5000~ 5499	Records for channel 3	500 records for channel 3	--
5500~ 5999	Records for channel 4	500 records for channel 4	--

5

5.2.5 Functions

HWCONFIG, built-in utility software in ISPSOft, can be used to set a module. Users can set modes and parameters by means of HWCONFIG.

- **Analog input**

Item	Function	Description
1	Enabling/Disabling a channel	1. Users can enable or disable a channel. 2. If a channel is disabled, the total conversion time is decreased.
2	Units of temperature	Users can select the unit of temperature, Fahrenheit or Celsius.
3	Calibration	Users can calibrate a linear curve.
4	Average	Conversion values are averaged and filtered.
5	Disconnection detection	If the channel is open, the module can detect if it is disconnected. If the input is open-circuited, the module will give an alarm or a warning.
6	Channel detect and alarm	If an input signal exceeds a range of inputs which can be received by hardware, the module will give an alarm or a warning. This function can be disabled.
7	The limit detections for channels	Saving the maximum/minimum values for channels
8	Records for channels	Saving the analog curves for channels
9	PID algorithm	PID control modes

1. Enabling/Disabling a channel

An analog signal is converted into a digital signal at a speed of 200ms a channel. If a channel is not used, users can disable it to decrease the total conversion time.

2. Units of temperature

Users can select unit of temperature, Fahrenheit or Celsius according to their needs.

3. Calibration

- To make a curve meet actual needs, users can calibrate the curve by changing an offset and a gain. A calibration range depends on a range of inputs which can be received by hardware. The formula is as below.

$$Output = \frac{(Input \times Gain)}{1000} + Offset$$

Example:

The gain is 1000, and the offset is 0. The corresponding value for the original signal 0°C to +100°C is 0~1000. When using the offset 100, the calibrated value for the original signal 0°C to +100°C is 100~1100.

Gain = 1000, Offset = 0

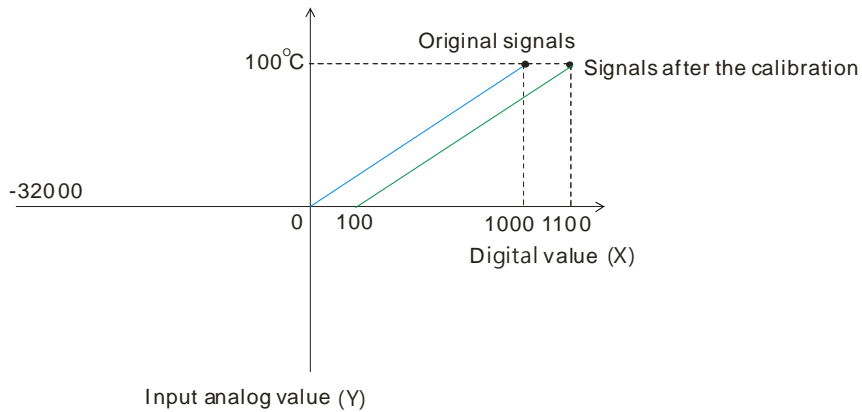

5

4. Average

The average value can be set in the range of 1~100. It is a steady value obtained from the sum of the read values. However, due to unavoidable external factors, the read values may be an acute pulse, resulting in fierce changes in the average value. The filtering function thus exclude the read value that is an acute pulse from the sum-up and equalization, so the average value obtained will not be affected by the acute read value. The filter percentage is set in the range of 0~3, and the unit is 10%. Setting 0 in the filter range, the system will sum up all the read values and equalize to obtain the average value; setting 1 in the filter range, the system will exclude the 10% of the maximum and minimum value and then equalize to obtain the average value.

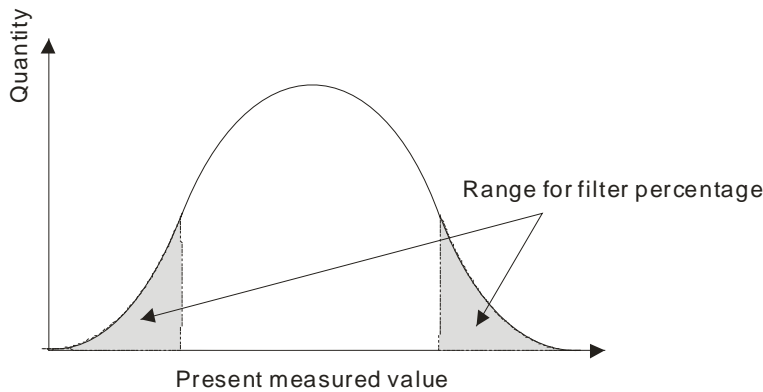

5. Disconnection detection

If the channel is open, the module can detect if it is disconnected. If the input is open-circuited, the module will give an alarm or a warning.

6. Channel detection

If an input signal exceeds a range of inputs which can be received by hardware, an error message appears. This function can be disabled and then the module will not send an alarm or warning when the input signal exceeding the range of inputs.

7. The limit detections for channels

Saving the maximum/minimum values for channels and users can know the peak to peak value from the maximum/minimum values

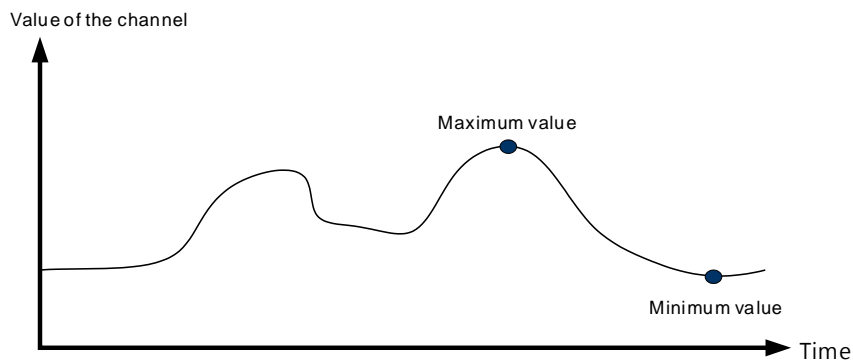

8. Records for channels

Record the input value of the cyclic sampling for each channel, up to 500 pieces can be recorded and the recording time is 10ms.

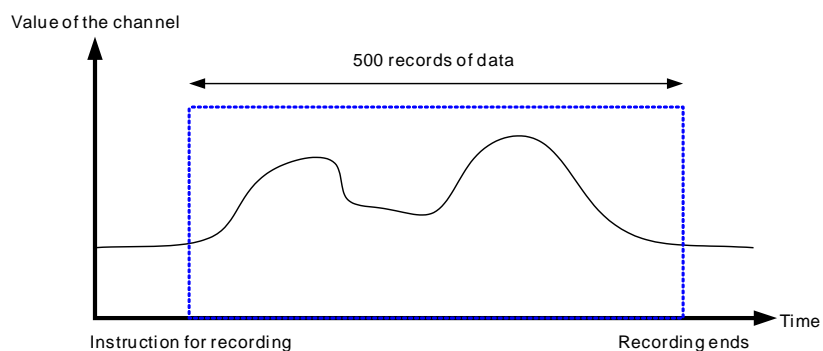

9. PID control

When the PV is in the range of ERR_DBW, the PLC will run the PID operation according to the E value. When the PV is over the SV, the cross status will be established and the E value will be seen as 0 while

running the PID operation until the PV goes over the range of ERR_DBW. If PID_DE is True, the PLC will run the derivative of PV. When the cross status is established, the Delta PV will be seen as 0 while running the derivative of PID operation. As the example shown below, the PLC will run the PID operation in the section A and will see the values of E and Delta PV as 0 while running the PID operation.

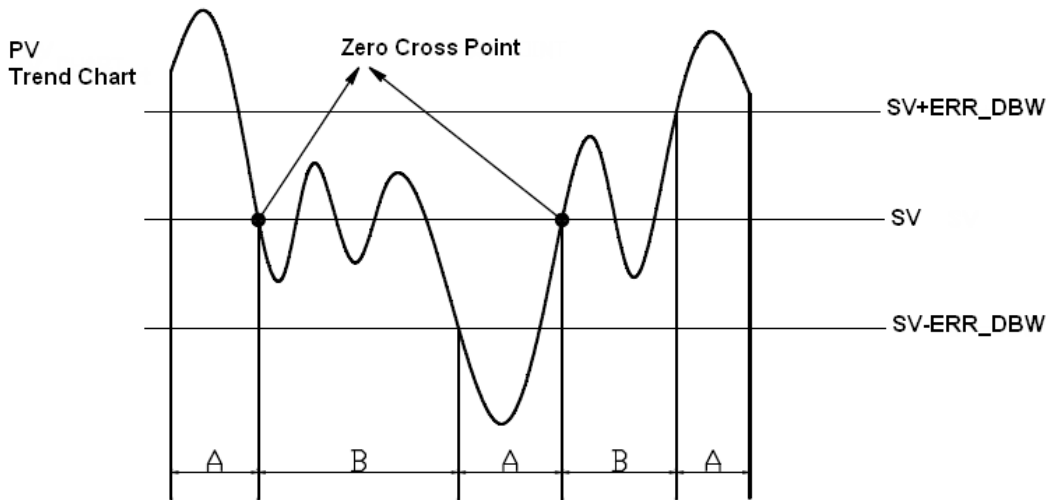

PID formula:

1. When the PID_MODE is set to 0, the mode is set to auto:

- Independent Formula & Derivative of E (PID_EQ=False & PID_DE=False)

$$CV = K_p E + K_i \int_0^t E dt + K_d \frac{dE}{dt} + BIAS$$

$$E = SV - PV \quad or \quad E = PV - SV$$

- Independent Formula & Derivative of PV (PID_EQ=False & PID_DE=Ture)

$$CV = K_p E + K_i \int_0^t E dt - K_d \frac{dPV}{dt} + BIAS$$

$$E = SV - PV$$

or

$$CV = K_p E + K_i \int_0^t E dt + K_d \frac{dPV}{dt} + BIAS$$

$$E = PV - SV$$

- **Dependent Formula & Derivative of E** (PID_EQ=True & PID_DE=False)

$$CV = K_c \left[E + \frac{1}{T_i} \int_0^t E dt + T_d \frac{dE}{dt} \right] + BIAS$$

$$E = SV - PV \quad \text{or} \quad E = PV - SV$$

- **Dependent Formula & Derivative of PV** (PID_EQ=True & PID_DE=True)

$$CV = K_c \left[E + \frac{1}{T_i} \int_0^t E dt - T_d \frac{dPV}{dt} \right] + BIAS$$

$$E = SV - PV$$

or

$$CV = K_c \left[E + \frac{1}{T_i} \int_0^t E dt + T_d \frac{dPV}{dt} \right] + BIAS$$

$$E = PV - SV$$

※ All the CVs stated above are the MVs in the formula.

- When the PID_MODE is set to 1, it is the auto tuning mode. When auto tuning is done, the value will become 0 and switch to the auto tuning mode automatically.

PID Control Block Diagram:

PID Block Diagram (Independent)

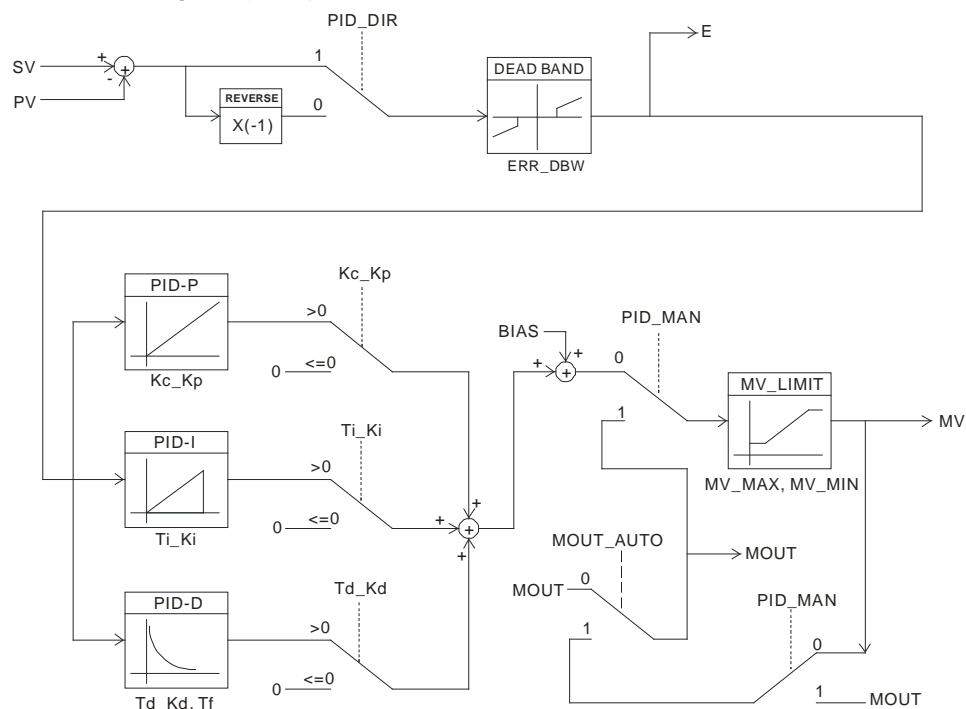

PID Block Diagram (Dependent)

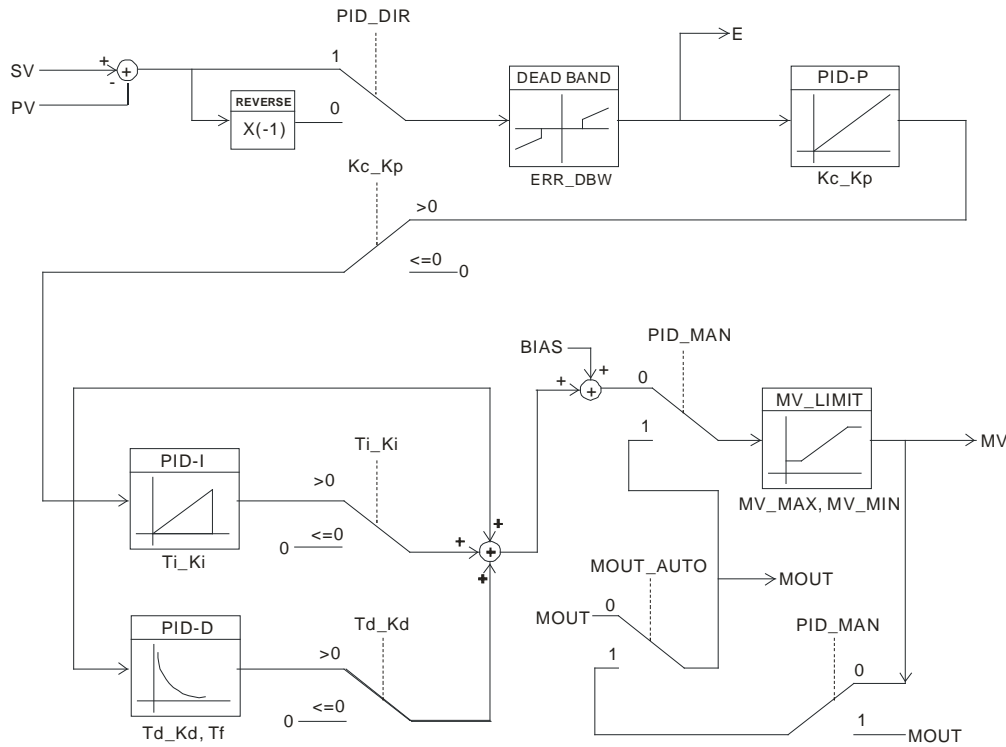

Note:

1. When tuning these 3 parameters, Kc_Kp, Ti_Ki and Td_Kd (**PID_MODE=0**), set the Kc_Kp value first (according to their experiences), and set the Ti_Ki and Td_Kd value to 0. When it can be controlled, users can increase the values of Ti_Ki and Td_Kd. When the value of Kc_Kp is 1, it means that the proportional gain is 100%. That is, the error is increased by a factor of one. When the proportional gain is less than 100%, the error is decreased. When the proportional gain is greater than 100%, the error is increased.
2. The parameters which have been tuned automatically are not necessarily suitable for every controlled environment. Therefore, users can further modify the automatically-tuned parameters. However, it is suggested to modify the values of Ti_Ki or Td_Kd only.

5.2.6 Control Mode

Users can set the output cycle according to the surroundings. (If the temperature is steady, the output cycle can be longer.)

Formula of the output cycle:

➤ Output cycle width = MV (%) x output cycle

Users can execute the instruction GPWN to set output cycle width and output cycle (sampling time) to do cycle control by.

Example:

If the output cycle is 200ms, after the PID algorithm is implemented, the output value is 50%.

➤ Output cycle width = 50 %×2000ms = 1000ms

Thus the instruction General pulse width modulation (GPWM) can be set as output cycle width is 1000 and output cycle is 2000.

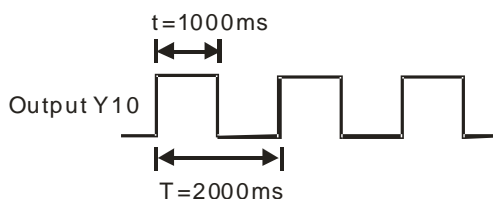

CR#				Operand	Function	Description	Setting range
CH1	CH2	CH3	CH4				
#600	#630	#660	#690	PID_RUN	Enabling the PID algorithm	1: The PID algorithm is implemented. 0: The output value (MV) is reset to 0, and the PID algorithm is not implemented.	0
#601	#631	#661	#691	SV	SV	Target value	0
#602	#632	#662	#692	PID_MODE	PID control mode	0: Automatic control When PID_MAN is switched from True to False, the output value (MV) then is involved in the automatic algorithm. 1: The parameters are tuned automatically for the temperature control. When the tuning of the parameters is complete, the device is automatically set to 0, and is filled in with appropriate parameters Kc_Kp, Ti_Ki, Td_Kd and Tf.	0
#603	#633	#663	#693	PID_MAN	PID A/M mode	0: Auto; the MV is output according to the PID algorithm. 1: Manual; the MV is output according to the MOUT. When PID_MODE is	0

CR#				Operand	Function	Description	Setting range
CH1	CH2	CH3	CH4				
						set to 1, the setting is ineffective.	
#604	#634	#664	#694	MOUT_AUTO	MOUT automatic change mode	0: Normal ; the MOUT deos not vary with the MV. 1 : Auto; the MOUT varies with the MV.	0
#605	#635	#665	#695	Auto tuning dead band	Auto tuning non-action zone	Setting range: 0~32000, used when SV±dead band in the auto tuning mode.	0
#606 #607	#636 #637	#666 #667	#696 #697	Kc_Kp	Calculated proportional coefficient (Kc or Kp)	Kc_Kp are floating-point numbers. If the P coefficient is less than 0, the Kc_Kp will be 0. Independently, if Kc_Kp is 0, it will not be controlled by P.	3.846
#608 #609	#638 #639	#668 #669	#698 #699	Ti_Ki	Integral coefficient (Ti or Ki)	Ti_Ki are floating-point numbers. If the calculated coefficient I is less than 0, Ti_Ki will be 0. If Ti_Ki is 0, it will not be controlled by I.	0.013
#610 #611	#640 #641	#670 #671	#700 #701	Td_Kd	Derivative coefficient (Td or Kd)	Td_Kd are floating-point numbers. If the calculated coefficient D is less than 0, Td_Kd will be 0. If Ti_Ki is 0, it will not be controlled by D.	190.0 78
#612 #613	#642 #643	#672 #673	#702 #703	Tf	Derivate-action time constant	If the derivate-action time constant is less than 0, Tf will be 0 and it will not be controlled by the derivate-action time constant. (Derivative Smoothing)	4.941
#614	#644	#674	#704	PID_EQ	PID formula types	0: Independent Formula 1: Dependent Formula	0
#615	#645	#675	#705	PID_DE	The calculation of the PID derivative error	0: Using the variations in the error (E) to calculate the control value of the derivative (Derivative of E). 1: Using the variations in the PV to calculate the control value of the derivative (Derivative of PV).	0

CR#				Operand	Function	Description	Setting range
CH1	CH2	CH3	CH4				
#616	#646	#676	#706	PID_DIR	PID forward/ reverse direction	0: heating action (E=SV-PV) 1: cooling action (E=PV-SV)	0
#617	#647	#677	#707	ERR_DBW	Range within which the error value is counted as 0.	The error value (E) is the difference between the SV and the PV. When the setting value is 0, the function is not enabled; otherwise the CPU module will check whether the present error is less than the absolute value of ERR_DBW, and check whether the present error meets the cross status condition. If the present error is less than the absolute value of ERR_DBW, and meets the cross status condition, the present error will be counted as 0, and the PID algorithm will be implemented, otherwise the present error will be brought into the PID algorithm according to the normal processing.	0
#618	#648	#678	#708	α value	Integral sum		31
#619	#649 #	#679	#709	β value	Integral sum	Setting range: 0~100, unit: 0.01	0
#620	#650	#680	#710	MOUT	Manual output value (MOUT)	When set to PID Manual, the MV value will be outputted as the manually set MOUNT value, between MV_MAX and MV_MIN. Setting range: 0~1000 (0~100%)	0
#621	#651	#681	#711	BIAS	Feedforward output value	Feedforward output value, used for the PID feedforward.	0
#622 #623	#652 #653	#682 #683	#712 #713	MV	Output value (MV)	The floating- point format; setting range: 0~100; unit: %	--

CR#				Operand	Function	Description	Setting range
CH1	CH2	CH3	CH4				
#624	#654	#684	#714	I_MV	Accumulated integral value	The floating- point format. Accumulated integral value temporarily stored is usually for reference. When the MV is out of the range 0~100%, the accumulated integral value in I_MV is unchanged.	--
#625	#655	#685	#715				
#626	#656	#686	#716	CYCLE	Sampling time (T_s)	When the instruction is scanned, the PID algorithm is implemented according to the sampling time, and the MV is refreshed. If T_s is less than 1, it will be counted as 1. If T_s is larger than 1,000, it will be counted as 1,000. Unit: 100ms	1

5.2.7 Wiring

● Precautions

In order to make the functions of an analog-to-digital module perfect and ensure the reliability of a system at the same time, external wiring which prevents noise is necessary. Before installing cables, users need to follow the precautions below.

- (1) To prevent a surge and induction, an AC cable and input signal cables which are connected to AS04RTD must be separate cables.
- (2) A cable must not be installed near a main circuit, a high-voltage cable, or a cable connected to a load which is not a PLC. Besides, a cable must not be bound to a main circuit, a high-voltage cable, or a cable connected to a load which is not a PLC. Otherwise, effects that noise, induction, and a surge have will increase.
- (3) Please connect a shielded cable and a hermetically sealed cable with the ground separately.
- (4) Terminals with insulation sleeves can not be arranged as a terminal block. It is recommended that the terminals be covered with insulation tubes.

- External wiring

(1) AS04RTD

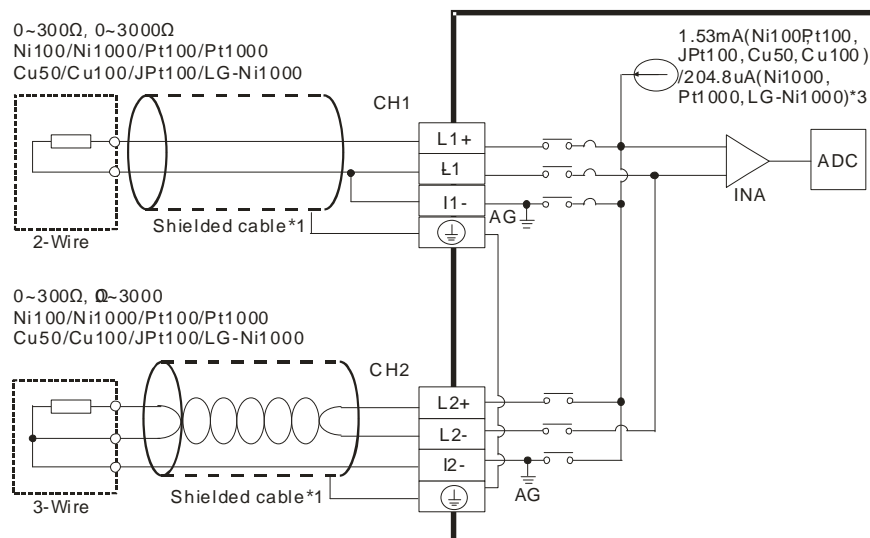

- *1. The cables or the shielded twisted pair cables for Ni100/Ni1000, Pt100/Pt1000, Cu50/Cu100, JPt100, LG-Ni1000 temperature sensors are used, and should be kept separate from other power cables and cables which generate noise. Please use a three-wire temperature sensor. If users want to use a two-wire temperature sensor, L_n+ and I_n+ have to be short-circuited, and L_n- and I_n- have to be short-circuited. (n is in the range of 1 to 4.)
- *2. If users want to measure the resistance in the range of 0 Ω to 300 Ω, they can use a two-wire or three-wire sensor instead of a four-wire sensor.
- *3. User need to select an appropriate sensor. If a Ni100 temperature sensor, a Pt100 sensor, a JPt100, Cu50/Cu100 or a resistance sensor is used, the internal excitation current is 1.53 mA. If a Ni1000 temperature sensor, a Pt1000 temperature sensor or LG-Ni1000 sensor is used, the internal excitation current is 204.8 μA.

5.2.8 LED Indicators

Number	Name	Description
1	RUN LED indicator	Operating status of the module ON: The module is running. OFF: The module stops running.
2	ERROR LED indicator	Error status of the module ON: A serious error occurs in the module. OFF: The module is normal. Blink: A slight error occurs in the module.
3	Digital to analog conversion indicator	Indicating the digital to analog conversion status Blinking: conversion is taking place OFF: stop conversion

5.2 HWCONFIG in ISPSOft

5.3.1 Initial Setting

- (1) Start ISPSOft, and then double-click **HWCONFIG**.

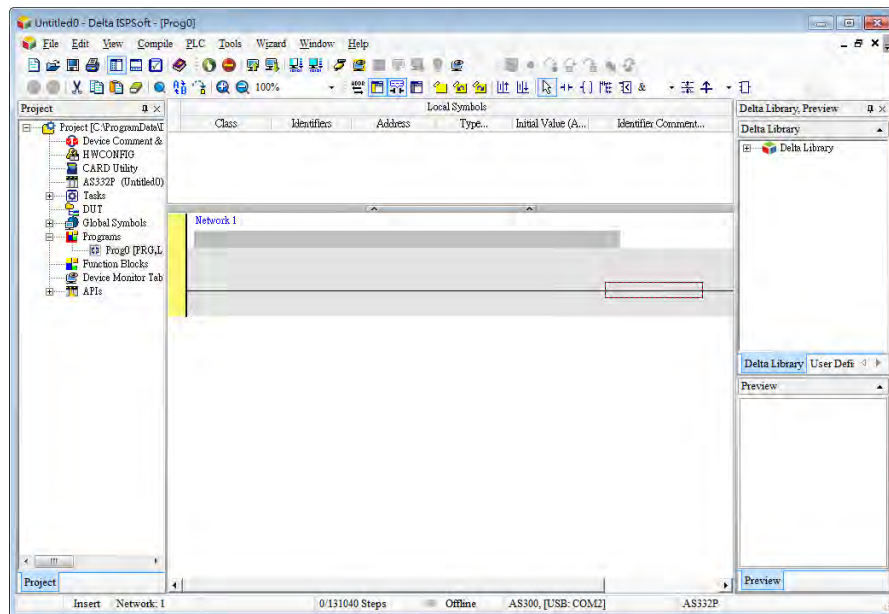

- (2) Selecting a module.

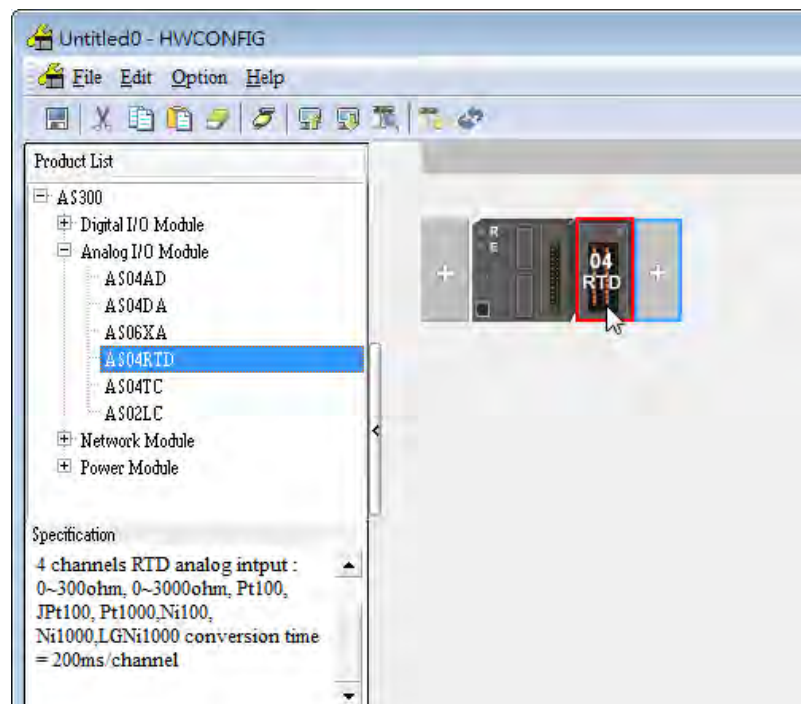

(3) Double-click the module to open the Device Setting page.

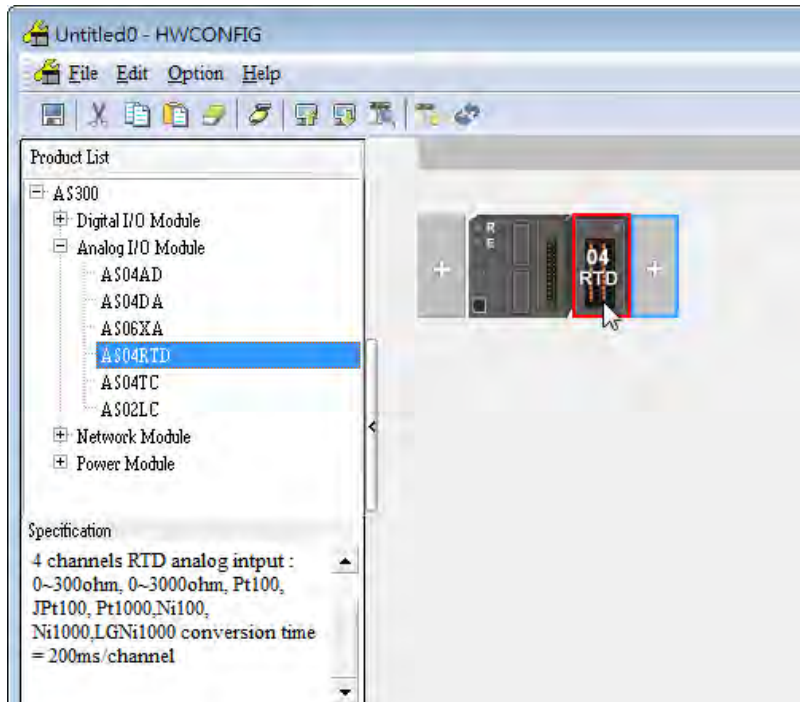

5

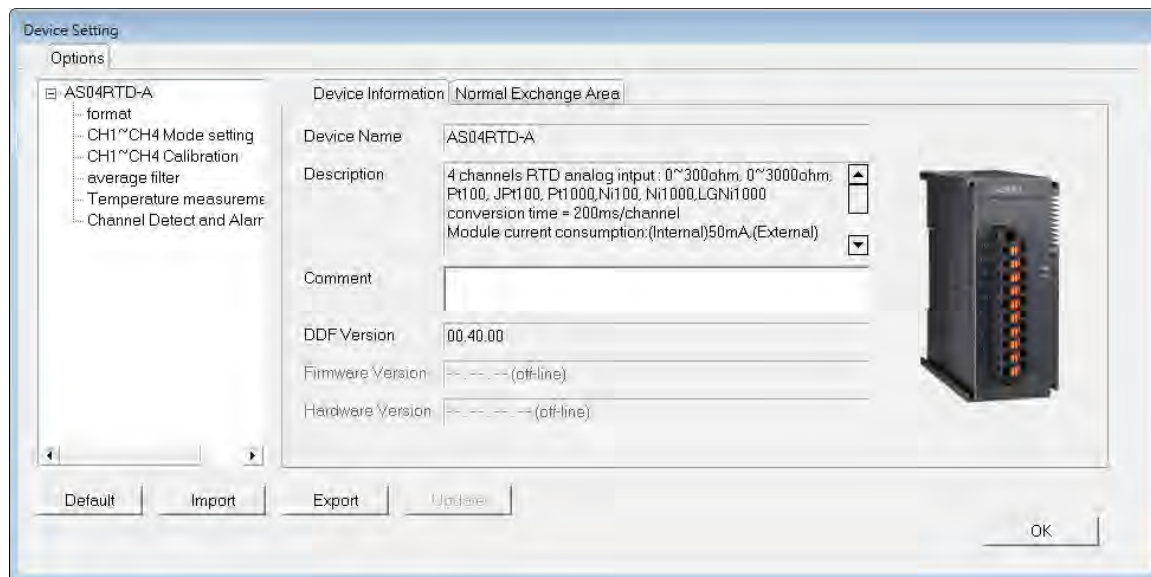

- (4) Set the parameters, and then click **OK**.

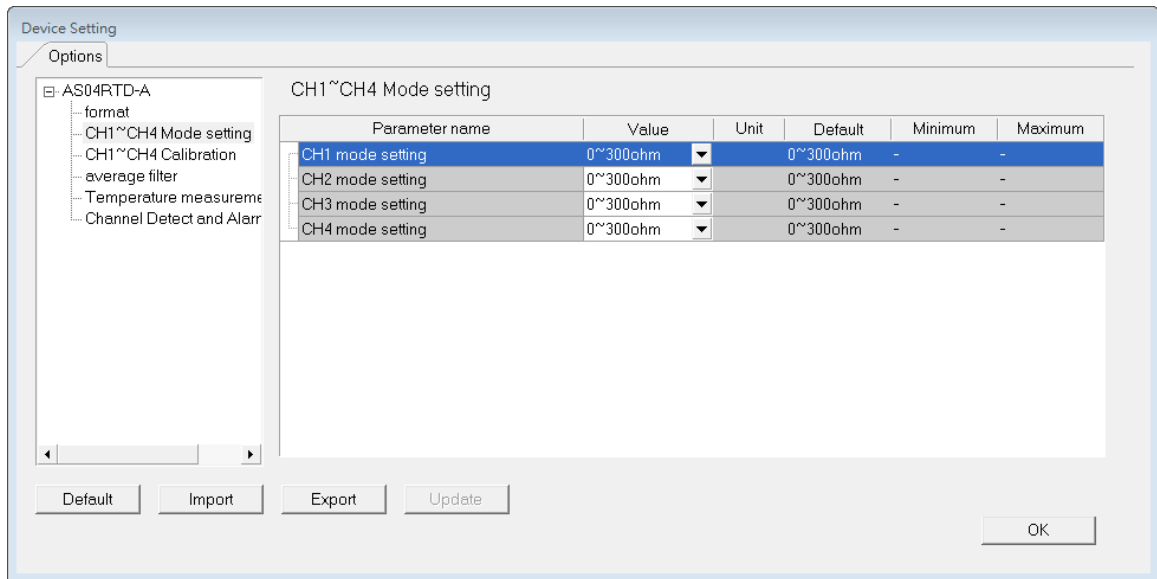

- (5) Click **Download** on the toolbar to download the parameters. (The parameters can not be downloaded when the CPU module runs.)

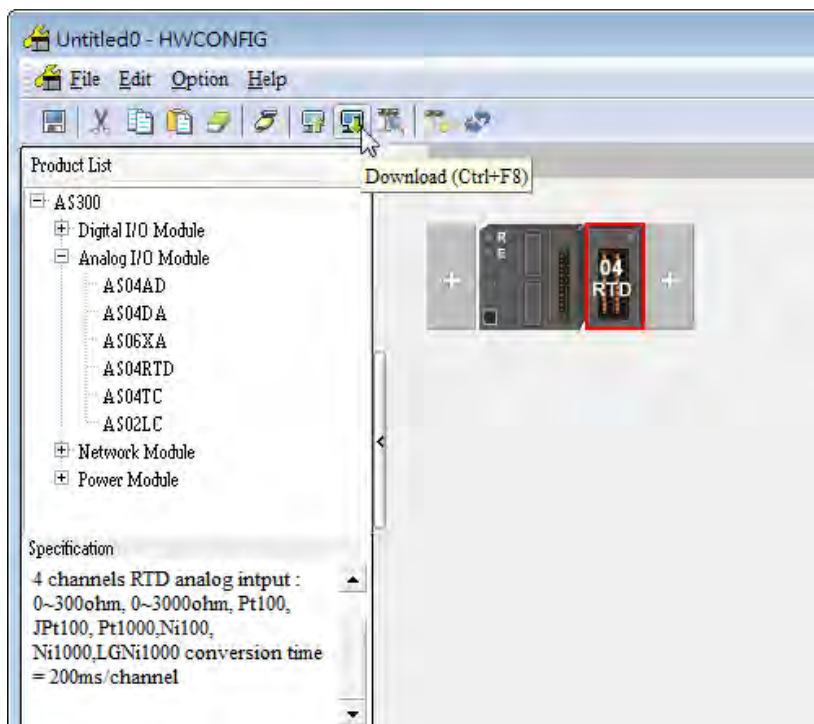

5.3.2 Checking the Version of a Module

(1) On the **Option** menu, click **Online Mode**.

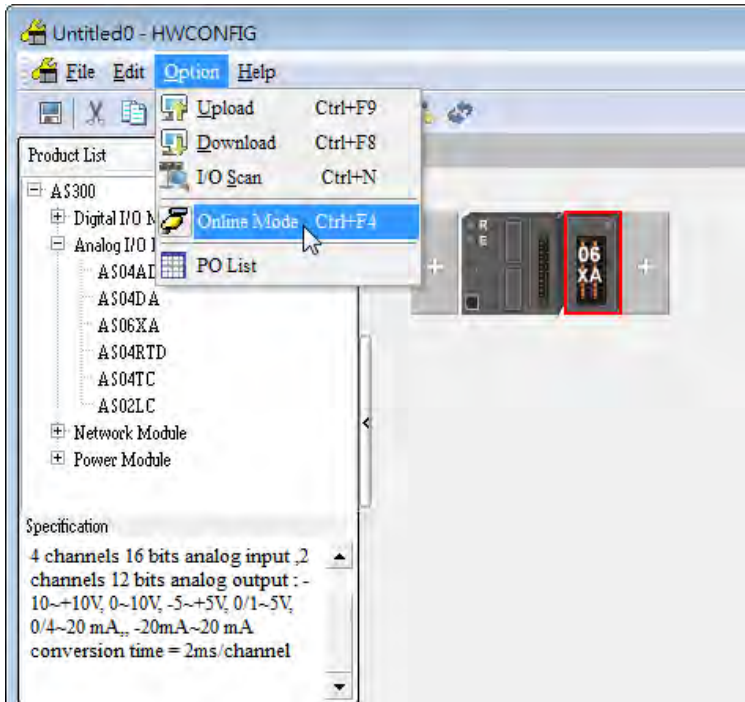

(2) Double-click the module to see the Device Setting page. The version of the firmware and that of the hardware are displayed.

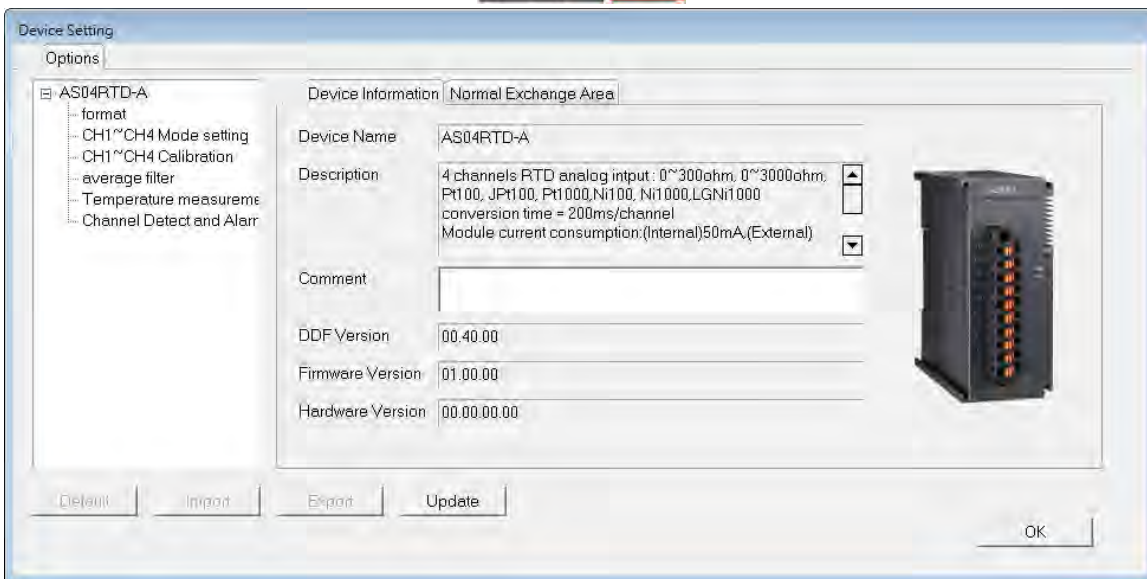

5.3.3 Online Mode

- (1) Click **Online Mode** on the toolbar.

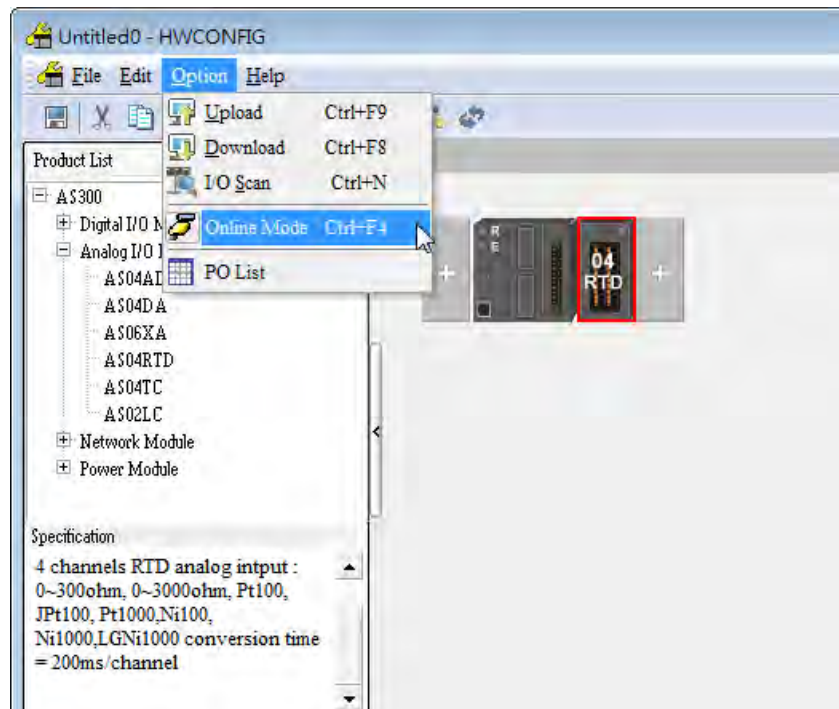

- (2) Right-click the module.

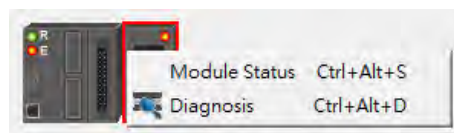

- (3) The module status can be shown.

Channel	Value (32 bits)	Data Type
Error code	6145	DECIMAL
CH1 Input	0	DECIMAL
CH2 Input	0	DECIMAL
CH3 Input	0	DECIMAL
CH4 Input	0	DECIMAL

5.3.4 Importing/Exporting a Parameter File

(1) After **Export** is clicked, the parameters will be saved as a CSV file (.csv).



5

(2) Click **Import**, and then select the CSV file.

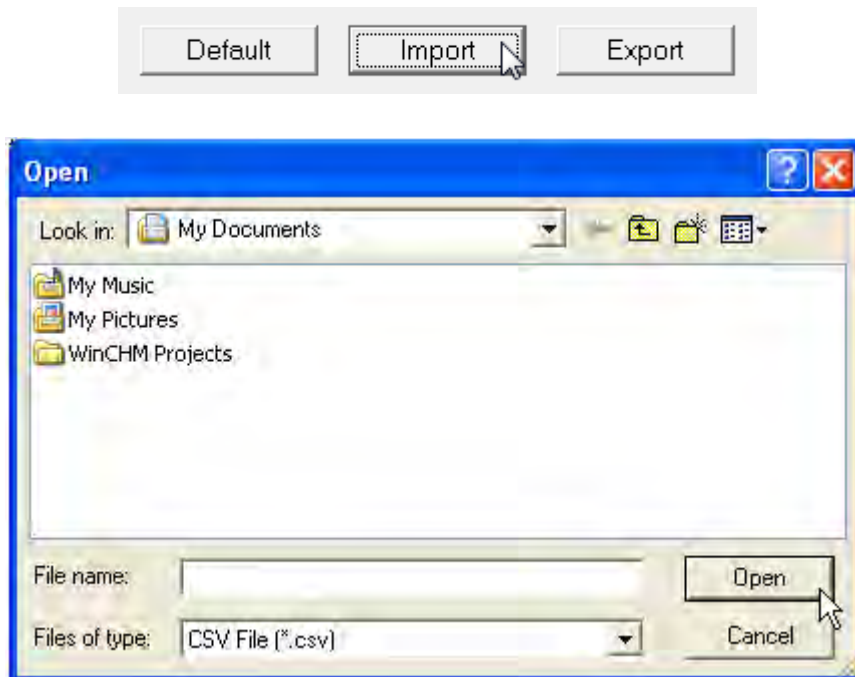

5.3.5 Parameters

(1) The input modes of the channels

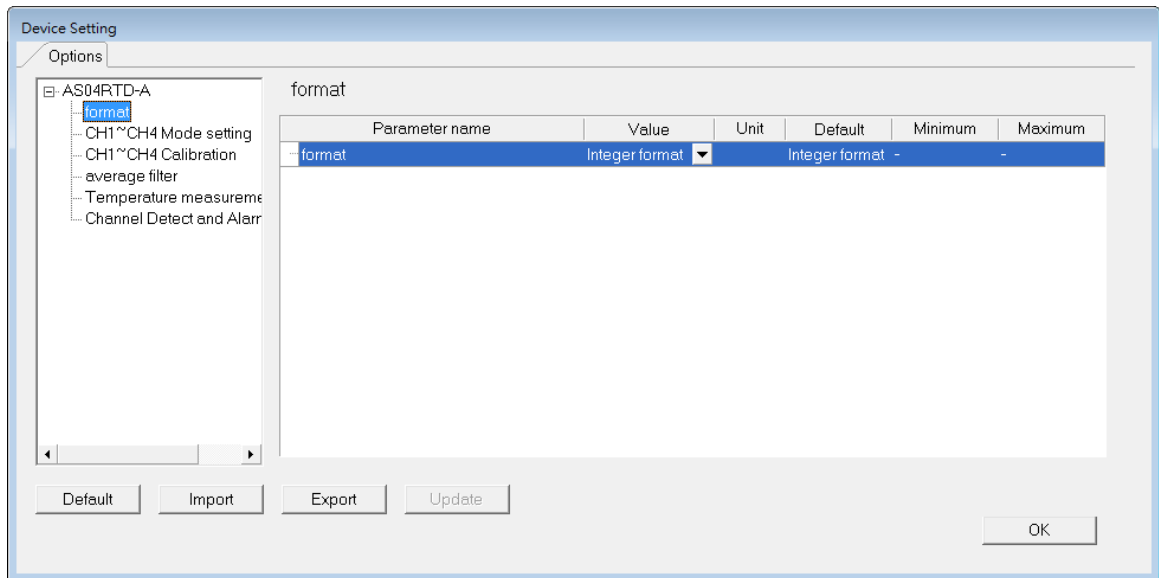

(2) Input CH1~CH4 Mode settings

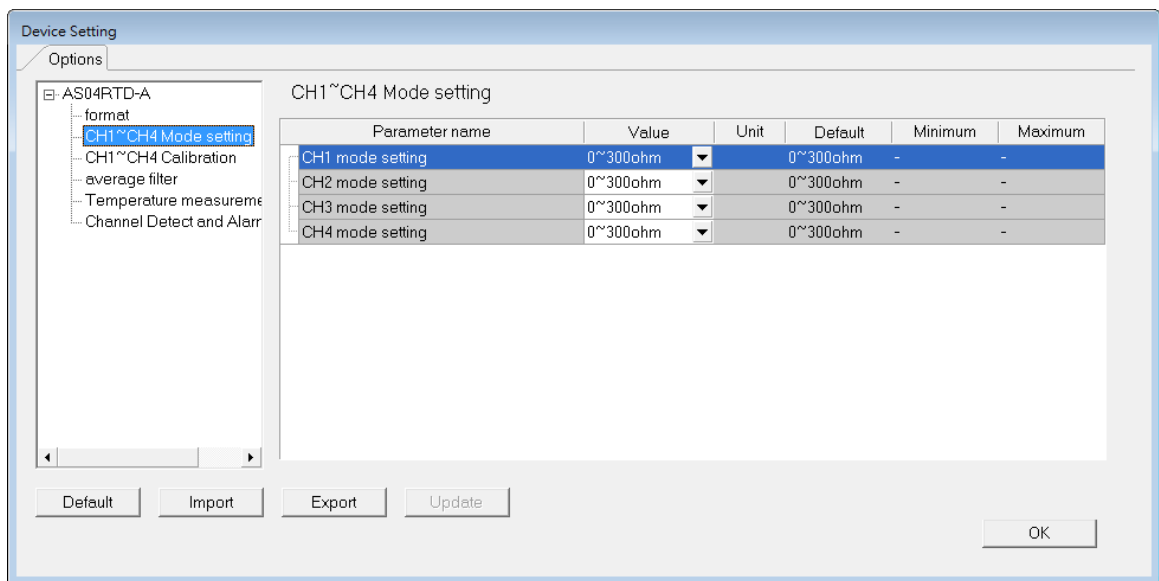

(3) Input CH1~CH4 calibration

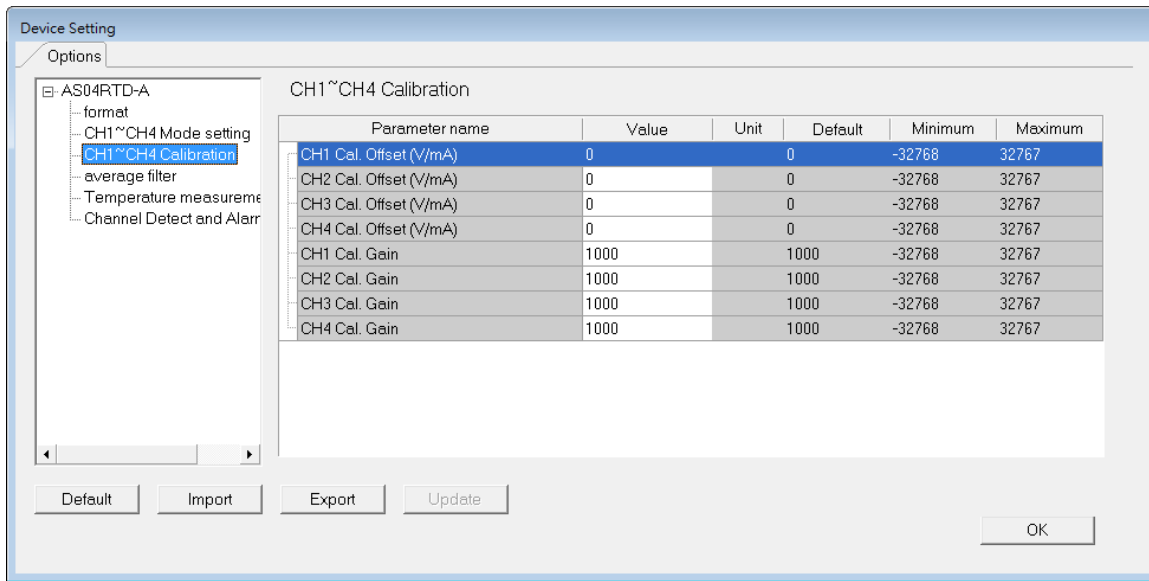

(4) Input average filter

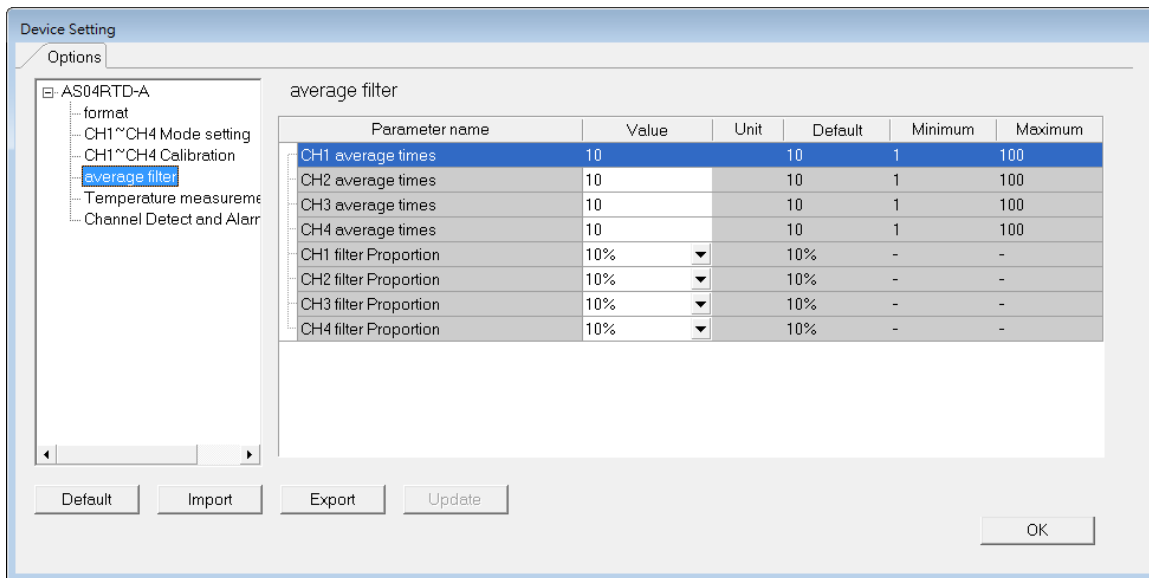

(5) Temperature measurement

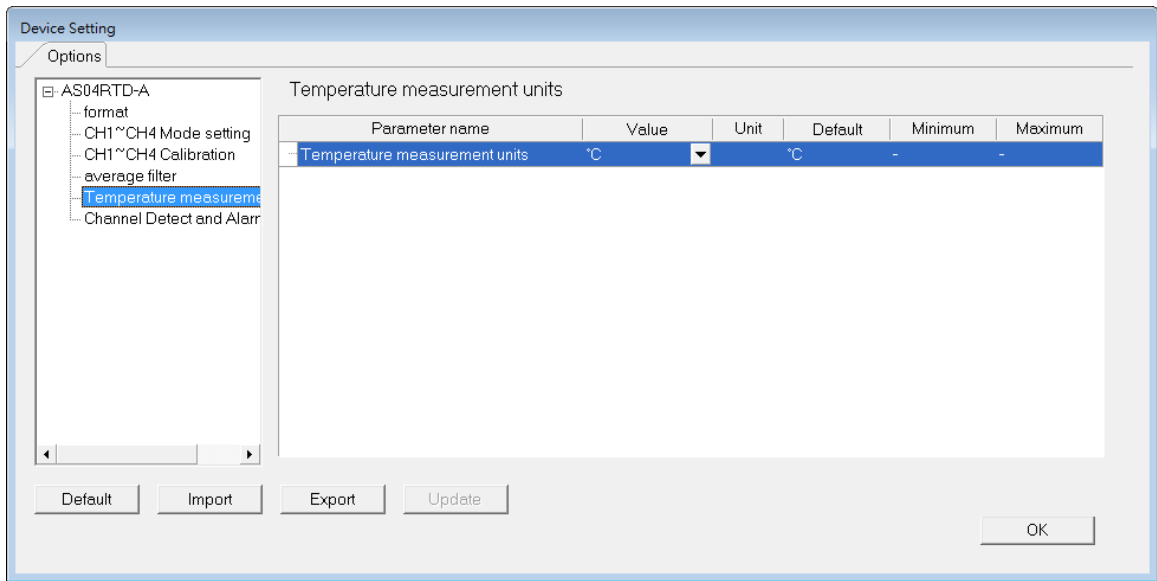

(6) Input channel detect and alarm settings

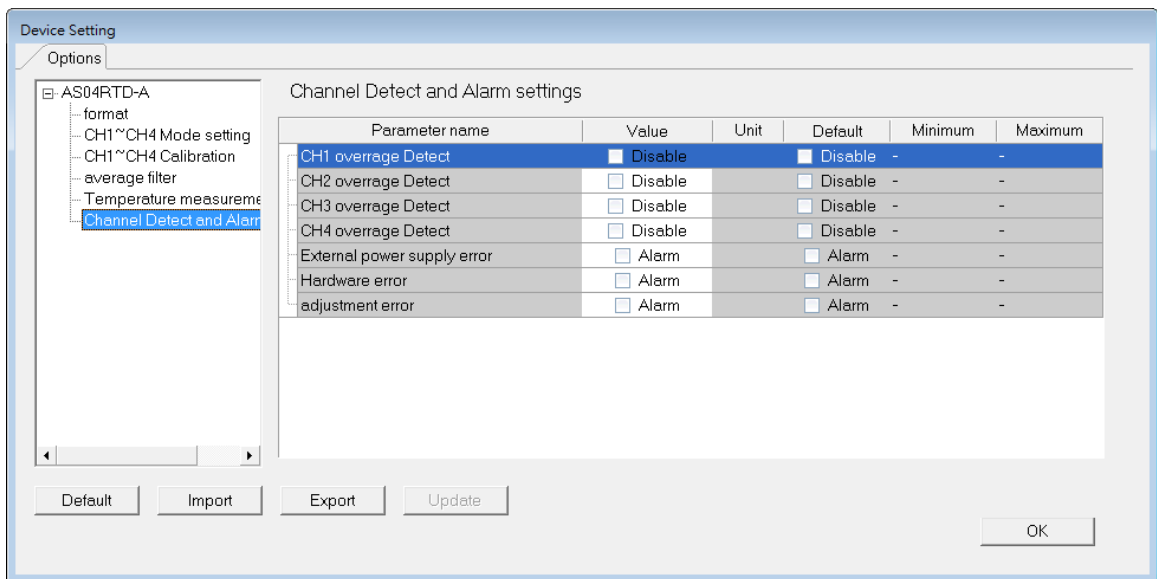

5.4 Troubleshooting

5.4.1 Error Codes

Error Code	Description	A↔D LED indicator	ERROR LED indicator
16#1605	Hardware failure	OFF	ON
16#1607	The external voltage is abnormal.	OFF	ON
16#1608	The factory calibration is abnormal.	OFF	ON
16#1801	The external voltage is abnormal.	OFF	Blinking
16#1802	Hardware failure	OFF	Blinking
16#1804	The factory calibration is abnormal.	OFF	Blinking
16#1808	The signal received by channel 1 exceeds the range of inputs which can be received by the hardware.	Run: blinking Stop: OFF	Blinking
16#1809	The signal received by channel 2 exceeds the range of inputs which can be received by the hardware.		
16#180A	The signal received by channel 3 exceeds the range of inputs which can be received by the hardware.		
16#180B	The signal received by channel 4 exceeds the range of inputs which can be received by the hardware.		

5.4.2 Troubleshooting Procedure

Description	Procedure
The external voltage is abnormal.	Check whether the external 24 V power supply to the module is normal.
Hardware failure	Return the module to the factory for repair.
Internal error The factory correction is abnormal.	Please contact the factory.
The signal received by channel 1 exceeds the range of inputs which can be received by the hardware.	Check the signal received by channel 1
The signal received by channel 2 exceeds the range of inputs which can be received by the hardware.	Check the signal received by channel 2.
The signal received by channel 3 exceeds the range of inputs which can be received by the hardware.	Check the signal received by channel 3.
The signal received by channel 4 exceeds the range of inputs which can be received by the hardware.	Check the signal received by channel 4.

5.4.3 State of the Connection

State of connection			Channel value
L+	L-	I-	
●	●	●	The maximum value for the channel
●	●		The maximum value for the channel
●		●	The maximum value for the channel
●			The maximum value for the channel
	●	●	The maximum value for the channel
	●		The maximum value for the channel
		●	The minimum value for the channel
●: Disconnection			

MEMO

Chapter 6 Temperature Measurement Module AS04TC

Table of Contents

6.1 Overview	6-2
6.1.1 Characteristics	6-3
6.2 Specifications and Functions	6-4
6.2.1 Specifications	6-4
6.2.2 Profile.....	6-5
6.2.3 Arrangement of Terminals	6-6
6.2.4 Control Registers	6-6
6.2.5 Functions	6-10
6.2.6 Control Mode.....	6-15
6.2.7 Wiring	6-19
6.2.8 LED Indicators.....	6-20
6.3 HWCONFIG in ISPSOft	6-21
6.3.1 Initial Setting	6-21
6.3.2 Checking the Version of a Module.....	6-24
6.3.3 Online Mode	6-25
6.3.4 Importing/Exporting a Parameter File	6-26
6.3.5 Parameters	6-27
6.4 Troubleshooting	6-30
6.4.1 Error Codes.....	6-30
6.4.2 Troubleshooting Procedure	6-31

6.1 Overview

The specifications for AS04TC-A, the operation, and the programming are described in this chapter. AS04TC-A are temperature measurement modules. They convert temperatures received from thermocouples (type J, K, R, S, T, E, N, B, $\pm 100\text{mV}$ voltage inputs) into digital signals. Users can select the degree Celsius (resolution: 0.1°C) or the degree Fahrenheit (resolution: 0.1°F) as a unit of measurement for temperature.

An introduction of thermocouples

The Seebeck effect is used in a thermocouple to measure a temperature difference. Generally speaking, a thermocouple consists of two conductors of different materials that produce a voltage in the vicinity of the point where the two conductors are in contact. The voltage produced is dependent on the difference of temperature of the junction to other parts of those conductors, and is in the range of several ten microvolts to several thousand microvolts. Therefore, the voltage produced needs to be amplified.

A thermocouple creates a voltage when there is a temperature difference. When a differential operation is performed on two pieces of data, external noise is eliminated. The stability of thermocouples is better than thermistors, resistance thermometers, and thermal resistors. Therefore, thermocouples are widely used in industry.

A thermocouple consists of a circuit having two wires of different metals or metal alloys welded together or joined at both ends. One of the junctions—normally the cold junction—is maintained at a known reference temperature, and the other junction is at the temperature to be sensed. A temperature gradient across the junction of the wires gives rise to an electric potential by the Seebeck effect. The voltage produced is proportional to the difference of temperature of the junction to other parts of those conductors.

The voltage can be derived from:

$$V = \int_{T_1}^{T_2} (Q_A - Q_B) dT \quad (\text{A})$$

where Q_A and Q_B are the thermopowers (Seebeck coefficient) of the metals A and B, and T_1 and T_2 are the temperatures of the two junctions.

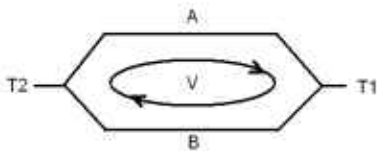

Principle of operation

In fact, Q_A and Q_B are almost unrelated to temperature. Therefore, formula (A) above can be approximated as (B) below.

$$V = \alpha(T_2 - T_1) \quad (\text{B})$$

There are two types of thermocouple thermometers. They are wrapped thermocouples and bare thermocouples. A wrapped thermocouple is wrapped in protective metal, and is similar to an electric spoon in appearance. Wrapped thermocouples are used to measure temperature of liquid, and bare thermocouples are used to measure temperature of gas.

6.1.1 Characteristics

(1) **A sensor is selected according to practical application.**

Type J thermocouples, type K thermocouples, type R thermocouples, type S thermocouples, type T thermocouples, type E thermocouples, type N thermocouples, and ± 100 mV voltage inputs.

(2) **A module is selected according to practical application.**

AS04TC-A: There are four channels. Inputs received by a channel are temperatures.

(3) **High-speed conversion**

A temperature is converted into a digital signal at a speed of 200 ms a channel.

(4) **High accuracy**

Conversion accuracy: The error is $\pm 0.1\%$ of an input. (The ambient temperature is $25 \pm 5^\circ\text{C}$.)

(5) **Disconnection detection**

When a sensor is disconnected, the module gives an alarm or a warning.

(6) **PID control**

An object can be maintained at a desired temperature through a PID control action.

(7) **A module can be set by means of utility software.**

HWCONFIG is built-in utility software in ISPSOFT. Users can set modes and parameters in HWCONFIG to complete hardware configuration without spending time writing a program to set registers corresponding to functions.

6.2 Specifications and Functions

6.2.1 Specifications

- Electrical specifications

Module name	AH04TC-A
Number of analog inputs	4
Applicable sensor	Type J, type K, type R, type S, type T, type E, type N, and type B thermocouples; ± 100 mV voltage inputs
Supply voltage	24 V DC (20.4 V DC~28.8 V DC) (-15%~+20%)
Connector type	Removable terminal block
Overall accuracy	25°C/77°F: The error allowed is $\pm 0.5\%$ of full scale. -20~60°C/-4~140°F: The error allowed is $\pm 1\%$ of full scale.
Conversion time	200 ms/channel
Isolation	An analog circuit is isolated from a digital circuit by a digital integrated circuit/an optocoupler, and the analog channels are isolated from one another by optocouplers. Isolation between a digital circuit and the ground: 500 VDC Isolation between an analog circuit and the ground: 500 VDC Isolation between an analog circuit and a digital circuit: 500 VDC Isolation between the 24 V DC and the ground: 500 VDC Isolation between analog channels: 120 VAC

- Functional specifications

Analog-to-digital conversion	Centigrade (°C)	Fahrenheit (°F)	Voltage input
Rated input range	Type J: -100°C~1,150°C Type K: -100°C~1,350°C Type R: 0°C~1,750°C Type S: 0°C~1,750°C Type T: -150°C~390°C Type E: -150°C~980°C Type N: -150°C~1,280°C Type B: 200°C~1,800°C	Type J: -148°F~2,102°F Type K: -148°F~2,462°F Type R: 32°F~3,182°F Type S: 32°F~3,182°F Type T: -238°F~734°F Type E: -238°F~1,796°F Type N: -238°F~2,336°F Type B: 32°F~3,182°F	± 100 mV
Average function	Range: 1~100		
Self-diagnosis	Disconnection detection		

6.2.2 Profile

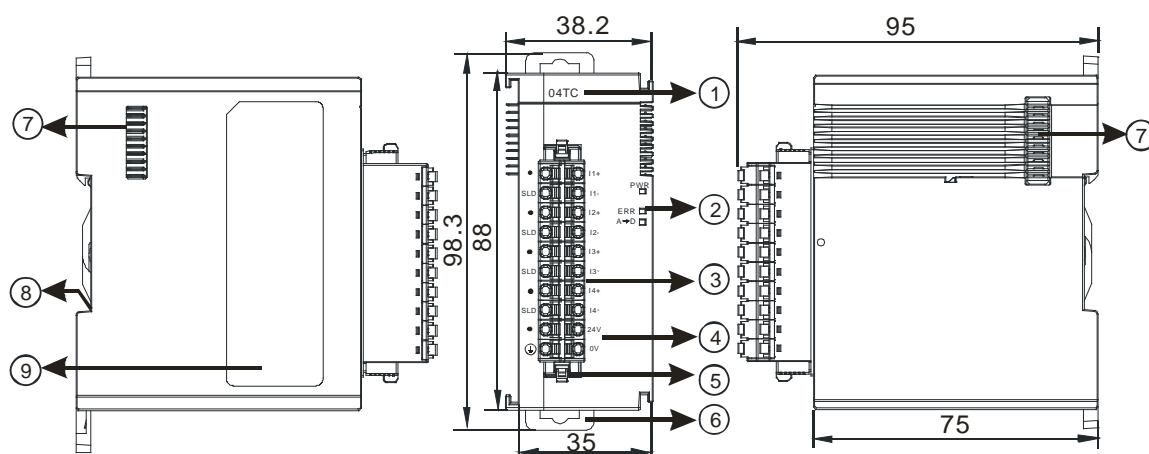

Unit: mm

Number	Name	Description
1	Model name	Model name of the module
2	RUN LED indicator	Operating status of the module ON: The module is running. OFF: The module stops running.
	ERROR LED indicator	Error status of the module ON: A serious error occurs in the module. OFF: The module is normal. Blink: A slight error occurs in the module.
	Digital to analog conversion indicator	Indicating the digital to analog conversion status Blinking: conversion is taking place OFF: stop conversion
3	Removable terminal block	The inputs are connected to transducers. The outputs are connected to loads which will be driven.
4	Arrangement of the input/output terminals	Arrangement of the terminals
5	Clip	Removing the terminal block
6	DIN rail clip	Securing the module onto the DIN rail
7	Module connecting set	Connecting the modules
8	Ground clip	

6.2.3 Arrangement of Terminals

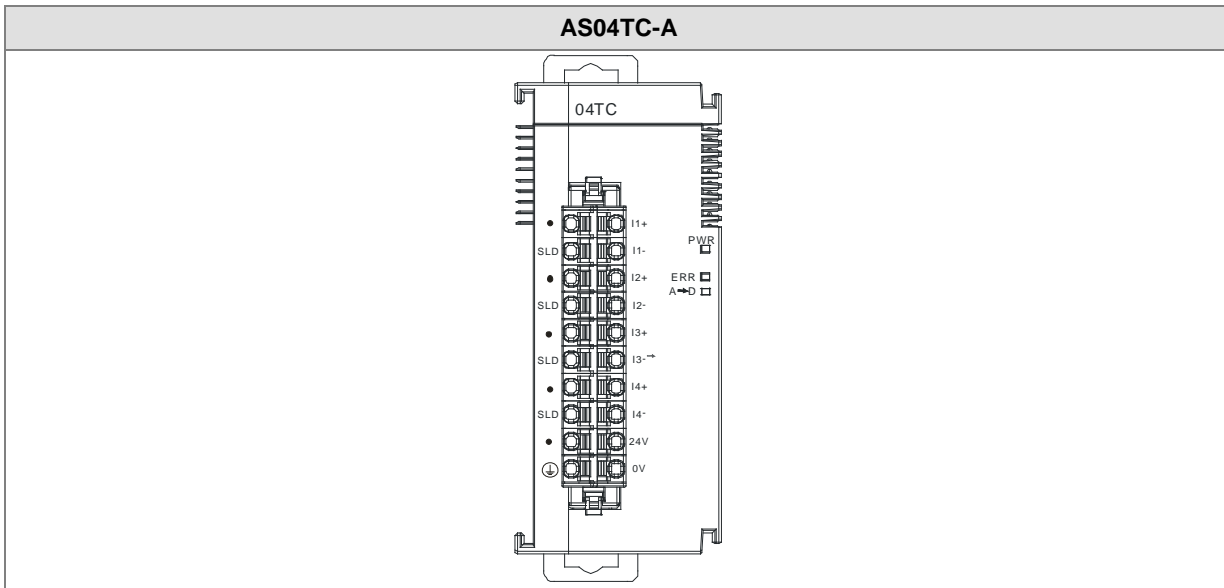

6.2.4 Control Registers

CR#	Name	Description	Defaults
0	Format setup	0: integer format 1: floating point format	0
1	Channel 1 mode setup	0: closed 1 : -100mV~100mV	1
2	Channel 2 mode setup	2 : J-Type 3 : K-Type	
3	Channel 3 mode setup	4 : R-Type 5 : S-Type 6 : T-Type	
4	Channel 4 mode setup	7 : E-Type 8 : N-Type 9 : B-Type	
5	Channel 1 offset	Setting range: -32768~32767	
6	Channel 2 offset		
7	Channel 3 offset		
8	Channel 4 offset		
9	Channel 1 gain	Setting range: -32768~32767	1000
10	Channel 2 gain		

CR#	Name	Description	Defaults
11	Channel 3 gain		
12	Channel 4 gain		
13	Channel 1 average times	Setting range: 1~100	10
14	Channel 2 average times		
15	Channel 3 average times		
16	Channel 4 average times		
17	Channel 1 filter average percentage	Setting range: 0~3, unit: $\pm 10\%$	1
18	Channel 2 filter average percentage		
19	Channel 3 filter average percentage		
20	Channel 4 filter average percentage		
21	Units of temperature	0: Fahrenheit 1: Celsius	0
22	Channel alarm setup	0: open channel alarm 1: close channel alarm bit0: Channel 1 bit1: Channel 2 bit2: Channel 3 bit3: Channel 4 0: warning 1: alarm bit8: Error occurs in the module power bit9: Error occurs in the module hardware bit10: Error occurs in calibration bit11: Error occurs in CJC temperature	0
201	Instruction set	16#0101: record the peak value again for channel 1 16#0102: record the peak value again for	0

CR#	Name	Description	Defaults
		channel 2 16#0104: record the peak value again for channel 3 16#0108: record the peak value again for channel 4 16#010F: record the peak value again for channel 1~4 16#0201: enable to record for channel 1 16#0202: enable to record for channel 2 16#0204: enable to record for channel 3 16#0208: enable to record for channel 4 16#020F: enable to record for channels 1~4 16#0211: disable to record for channel 1 16#0212: disable to record for channel 2 16#0214: disable to record for channel 3 16#0218: disable to record for channel 4 16#021F: disable to record for channel 1~4 16#0502: restore to its default settings	
210	The maximum peak value for channel 1	Interger format; the maximum peak value for analog inputs	-
211	The maximum peak value for channel 2		-
212	The maximum peak value for channel 3		-
213	The maximum peak value for channel 4		-
214	The minimum peak value for channel 1	Interger format; the minimum peak value for analog inputs	-
215	The minimum peak value for channel 2		-
216	The minimum peak value for channel 3		-
217	The minimum peak value for channel 4		-

6

CR#	Name	Description	Defaults
222	The time to record for channel 1	Unit: 100ms, setting range 1~100 Setting the time to record the digital value for the channels	1
223	The time to record for channel 2		1
224	The time to record for channel 3		1
225	The time to record for channel 4		1
240	The number of records for channel 1	Range: 0~500, display the current records	0
241	The number of records for channel 2		0
242	The number of records for channel 3		0
243	The number of records for channel 4		0
4000~ 4499	Records for channel 1	500 records for channel 1	--
4500~ 4999	Records for channel 2	500 records for channel 2	--
5000~ 5499	Records for channel 3	500 records for channel 3	--
5500~ 5999	Records for channel 4	500 records for channel 4	--

6.2.5 Functions

Item	Function	Description
1	Enabling/Disabling a channel	1. Users can enable or disable a channel. 2. If a channel is disabled, the total conversion time is decreased.
2	Units of temperature	Users can select the unit of temperature, Fahrenheit or Celsius.
3	Calibration	Users can calibrate a linear curve.
4	Average	Conversion values are averaged and filtered.
5	Disconnection detection	If the channel is open, the module can detect if it is disconnected. If the input is open-circuited, the module will give an alarm or a warning.
6	Channel detect and alarm	If an input signal exceeds a range of inputs which can be received by hardware, the module will give an alarm or a warning. This function can be disabled.
7	The limit detections for channels	Saving the maximum/minimum values for channels
8	Records for channels	Saving the analog curves for channels
9	PID algorithm	PID control modes

1. Enabling/Disabling a channel

An analog signal is converted into a digital signal at a speed of 200ms a channel. If a channel is not used, users can disable it to decrease the total conversion time.

2. Units of temperature

Users can select unit of temperature, Fahrenheit or Celsius according to their needs.

3. Calibration

- To make a curve meet actual needs, users can calibrate the curve by changing an offset and a gain. A calibration range depends on a range of inputs which can be received by hardware. The formula is as below.

$$Output = \frac{(Input \times Gain)}{1000} + Offset$$

Example:

The gain is 1000, and the offset is 0. The corresponding value for the original signal 0°C to +100°C is 0~1000. When using the offset 100, the calibrated value for the original signal 0°C to +100°C is 100~1100.

Gain = 1000, Offset = 0

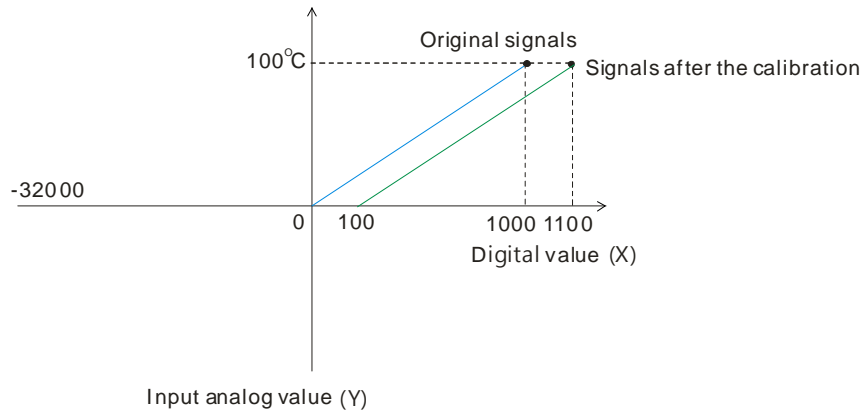

4. Average

The average value can be set in the range of 1~100. It is a steady value obtained from the sum of the read values. However, due to unavoidable external factors, the read values may be an acute pulse, resulting in fierce changes in the average value. The filtering function thus exclude the read value that is an acute pulse from the sum-up and equalization, so the average value obtained will not be affected by the acute read value. The filter percentage is set in the range of 0~3, and the unit is 10%. Setting 0 in the filter range, the system will sum up all the read values and equalize to obtain the average value; setting 1 in the filter range, the system will exclude the 10% of the maximum and minimum value and then equalize to obtain the average value.

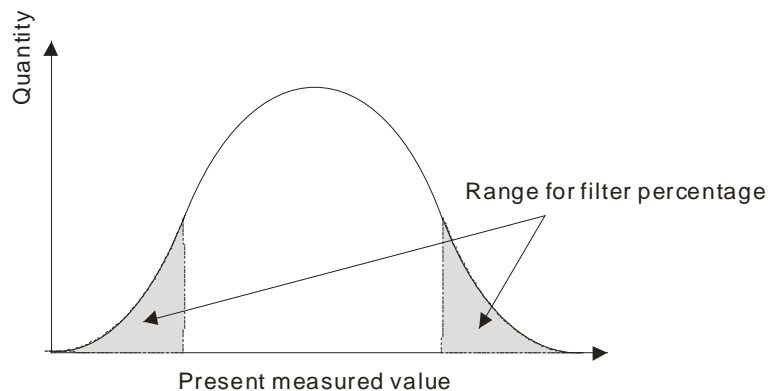

5. Disconnection detection

If the channel is open, the module can detect if it is disconnected. If the input is open-circuited, the module will give an alarm or a warning.

6. Channel detection

If an input signal exceeds a range of inputs which can be received by hardware, an error message will appear and the Error LED will blink. This function can be disabled and then the module will not send an alarm or warning, the Error LED will not blink either, when the input signal exceeding the range of inputs.

7. The limit detections for channels

Saving the maximum/minimum values for channels and users can know the peak to peak value from the maximum/minimum values

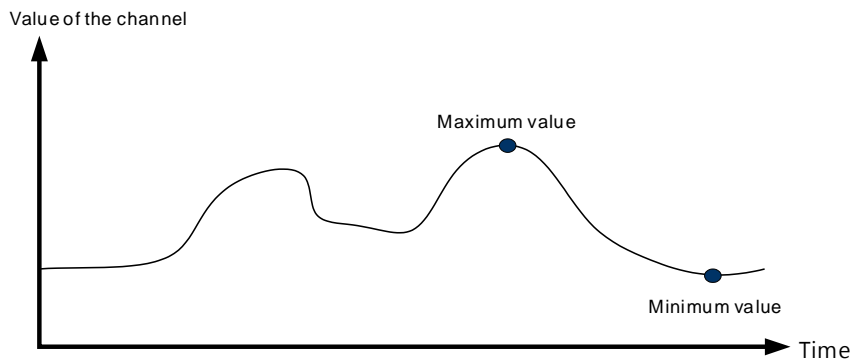

8. Records for channels

Record the input value of the cyclic sampling for each channel, up to 500 pieces can be recorded and the recording time is 10ms. If the conversion time is 2ms, and 4 channels are open, the recording time will be $8\text{ms} \times 500$ pieces (4 seconds in total).

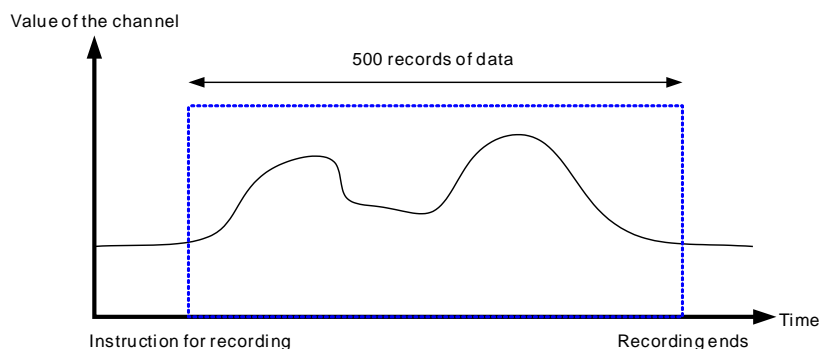

9. PID control

When the PV is in the range of ERR_DBW, the PLC will run the PID operation according to the E value. When the PV is over the SV, the cross status will be established and the E value will be seen as 0 while running the PID operation until the PV goes over the range of ERR_DBW. If PID_DE is True, the PLC will run the derivative of PV. When the cross status is established, the Delta PV will be seen as 0 while running the derivative of PID operation. As the example shown below, the PLC will run the PID operation in the section A and will see the values of E and Delta PV as 0 while running the PID operation.

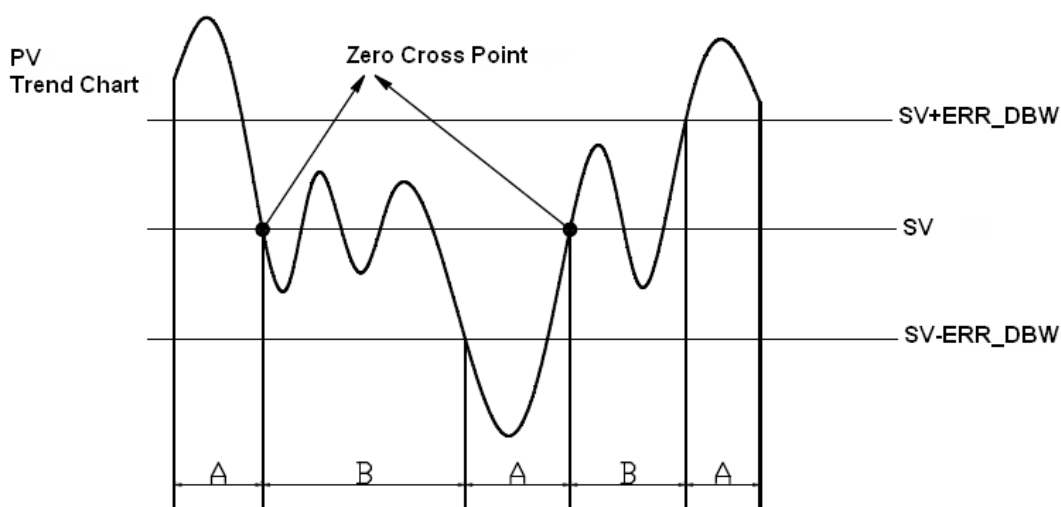

PID formula:

1. When the PID_MODE is set to 0, the mode is set to auto:

- Independent Formula & Derivative of E (PID_EQ=False & PID_DE=False)

$$CV = K_p E + K_i \int_0^t E dt + K_d \frac{dE}{dt} + BIAS$$

$$E = SV - PV \quad \text{or} \quad E = PV - SV$$

- Independent Formula & Derivative of PV (PID_EQ=False & PID_DE=True)

$$CV = K_p E + K_i \int_0^t E dt - K_d \frac{dPV}{dt} + BIAS$$

$$E = SV - PV$$

or

$$CV = K_p E + K_i \int_0^t E dt + K_d \frac{dPV}{dt} + BIAS$$

$$E = PV - SV$$

- Dependent Formula & Derivative of E (PID_EQ=True & PID_DE=False)

$$CV = K_c \left[E + \frac{1}{T_i} \int_0^t E dt + T_d \frac{dE}{dt} \right] + BIAS$$

$$E = SV - PV \quad \text{or} \quad E = PV - SV$$

- **Dependent Formula & Derivative of PV** (PID_EQ=True & PID_DE=True)

$$CV = K_c \left[E + \frac{1}{T_i} \int_0^t E dt - T_d \frac{dPV}{dt} \right] + BIAS$$

$$E = SV - PV$$

or

$$CV = K_c \left[E + \frac{1}{T_i} \int_0^t E dt + T_d \frac{dPV}{dt} \right] + BIAS$$

$$E = PV - SV$$

※ All the CVs stated above are the MVs in the formula.

- When the PID_MODE is set to 1, it is the auto tuning mode. When auto tuning is done, the value will become 0 and switch to the auto tuning mode automatically.

PID Control Block Diagram:

PID Block Diagram (Independent)

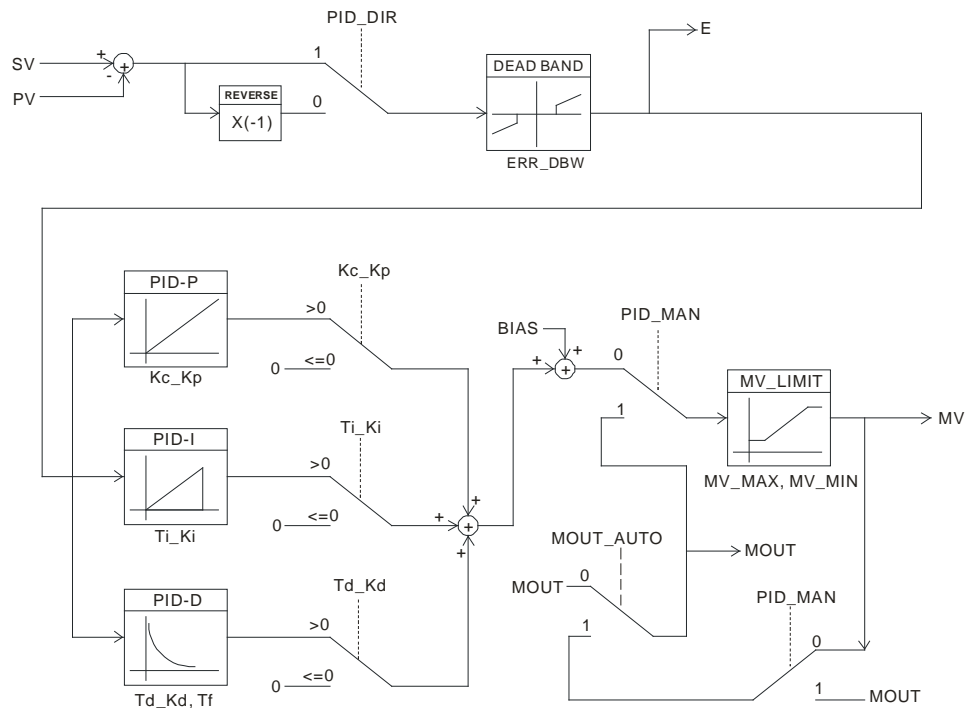

PID Block Diagram (Dependent)

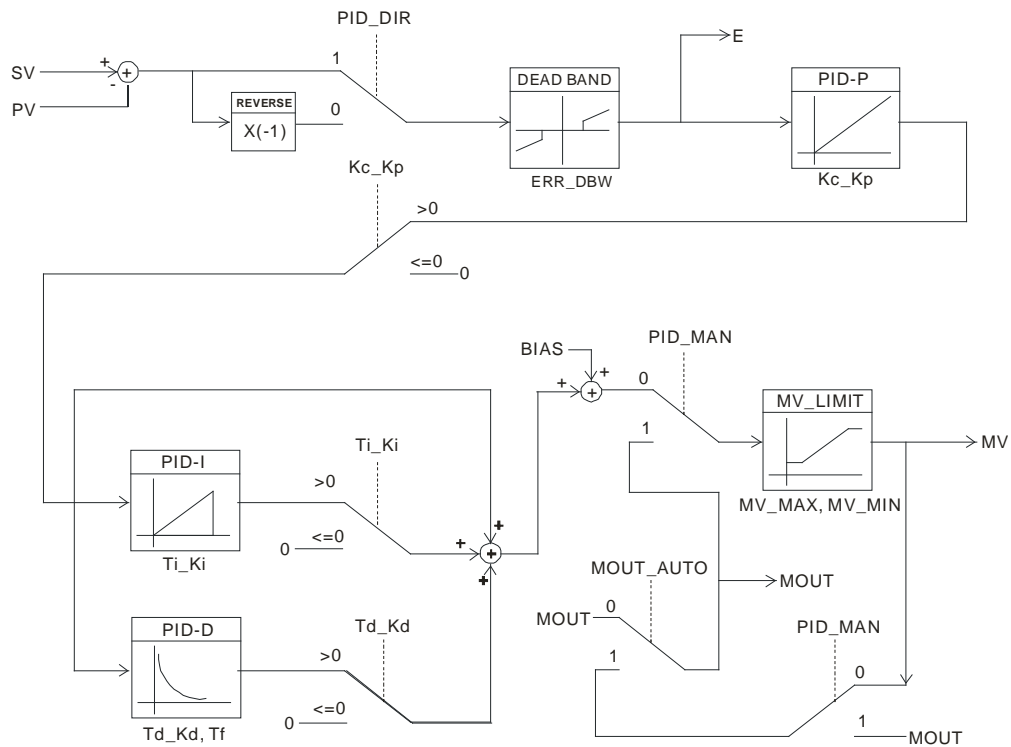

Note:

1. When tuning these 3 parameters, Kc_Kp, Ti_Ki and Td_Kd (**PID_MODE=0**), set the Kc_Kp value first (according to their experiences), and set the Ti_Ki and Td_Kd value to 0. When it can be controlled, users can increase the values of Ti_Ki and Td_Kd. When the value of Kc_Kp is 1, it means that the proportional gain is 100%. That is, the error is increased by a factor of one. When the proportional gain is less than 100%, the error is decreased. When the proportional gain is greater than 100%, the error is increased.
2. The parameters which have been tuned automatically are not necessarily suitable for every controlled environment. Therefore, users can further modify the automatically-tuned parameters. However, it is suggested to modify the values of Ti_Ki or Td_Kd only.

6.2.6 Control Mode

Users can set the output cycle according to the surroundings. (If the temperature is steady, the output cycle can be longer.)

Formula of the output cycle:

➤ Output cycle width = MV (%) x output cycle

Users can execute the instruction GPWN to set output cycle width and output cycle (sampling time) to do cycle control by.

Example:

If the output cycle is 200ms, after the PID algorithm is implemented, the output value is 50%.

➤ Output cycle width = 50 %×2000ms = 1000ms

Thus the instruction General pulse width modulation (GPWM) can be set as output cycle width is 1000 and output cycle is 2000.

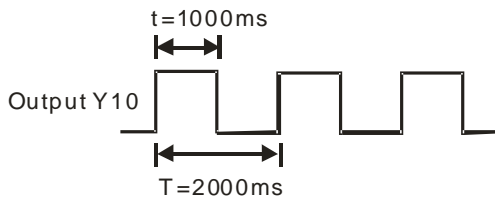

CR#				Operand	Function	Description	Setting range
CH1	CH2	CH3	CH4				
#600	#630	#660	#690	PID_RUN	Enabling the PID algorithm	1: The PID algorithm is implemented. 0: The output value (MV) is reset to 0, and the PID algorithm is not implemented.	0
#601	#631	#661	#691	SV	SV	Target value	0
#602	#632	#662	#692	PID_MODE	PID control mode	0: Automatic control When PID_MAN is switched from True to False, the output value (MV) then is involved in the automatic algorithm. 1: The parameters are tuned automatically for the temperature control. When the tuning of the parameters is complete, the device is automatically set to 0, and is filled in with appropriate parameters Kc_Kp, Ti_Ki, Td_Kd and Tf.	0
#603	#633	#663	#693	PID_MAN	PID A/M mode	0: Auto; the MV is output according to the PID algorithm. 1: Manual; the MV is output	0

6

CR#				Operand	Function	Description	Setting range
CH1	CH2	CH3	CH4				
						according to the MOUT. When PID_MODE is set to 1, the setting is ineffective.	
#604	#634	#664	#694	MOUT_AUTO	MOUT automatic change mode	0: Normal ; the MOUT deos not vary with the MV. 1 : Auto; the MOUT varies with the MV.	0
#605	#635	#665	#695	Auto tuning dead band	Auto tuning non-action zone	Setting range: 0~32000, used when SV±dead band in the auto tuning mode.	0
#606	#636	#666	#696	Kc_Kp	Calculated proportional coefficient (Kc or Kp)	Kc_Kp are floating-point numbers. If the P coefficient is less than 0, the Kc_Kp will be 0. Independently, if Kc_Kp is 0, it will not be controlled by P.	3.846
#607	#637	#667	#697				
#608	#638	#668	#698	Ti_Ki	Integral coefficient (Ti or Ki)	Ti_Ki are floating-point numbers. If the calculated coefficient I is less than 0, Ti_Ki will be 0. If Ti_Ki is 0, it will not be controlled by I.	0.013
#609	#639	#669	#699				
#610	#640	#670	#700	Td_Kd	Derivative coefficient (Td or K _d)	Td_Kd are floating-point numbers. If the calculated coefficient D is less than 0, Td_Kd will be 0. If Ti_Ki is 0, it will not be controlled by D.	190.0 78
#611	#641	#671	#701				
#612	#642	#672	#702	Tf	Derivate-action time constant	If the derivate-action time constant is less than 0, Tf will be 0 and it will not be controlled by the derivate-action time constant. (Derivative Smoothing)	4.941
#613	#643	#673	#703				
#614	#644	#674	#704	PID_EQ	PID formula types	0: Independent Formula 1: Dependent Formula	0
#615	#645	#675	#705	PID_DE	The calculation of the PID derivative error	0: Using the variations in the error (E) to calculate the control value of the derivative (Derivative of E).	0

CR#				Operand	Function	Description	Setting range
CH1	CH2	CH3	CH4				
						1: Using the variations in the PV to calculate the control value of the derivative (Derivative of PV).	
#616	#646	#676	#706	PID_DIR	PID forward/ reverse direction	0: heating action (E=SV-PV) 1: cooling action (E=PV-SV)	0
#617	#647	#677	#707	ERR_DBW	Range within which the error value is counted as 0.	The error value (E) is the difference between the SV and the PV. When the setting value is 0, the function is not enabled; otherwise the CPU module will check whether the present error is less than the absolute value of ERR_DBW, and check whether the present error meets the cross status condition. If the present error is less than the absolute value of ERR_DBW, and meets the cross status condition, the present error will be counted as 0, and the PID algorithm will be implemented, otherwise the present error will be brought into the PID algorithm according to the normal processing.	0
#618	#648	#678	#708	α value	Integral sum		31
#619	#649 #	#679	#709	β value	Integral sum	Setting range: 0~100, unit: 0.01	0
#620	#650	#680	#710	MOUT	Manual output value (MOUT)	When set to PID Manual, the MV value will be outputted as the manually set MOUNT value, between MV_MAX and MV_MIN. Setting range: 0~1000 (0~100%)	0
#621	#651	#681	#711	BIAS	Feedforward output value	Feedforward output value, used for the PID feedforward.	0

CR#				Operand	Function	Description	Setting range
CH1	CH2	CH3	CH4				
#622	#652	#682	#712	MV	Output value (MV)	The floating- point format; setting range: 0~100; unit: %	--
#623	#653	#683	#713				
#624	#654	#684	#714	I_MV	Accumulated integral value	The floating- point format. Accumulated integral value temporarily stored is usually for reference. When the MV is out of the range 0~100%, the accumulated integral value in I_MV is unchanged.	--
#625	#655	#685	#715				
#626	#656	#686	#716	CYCLE	Sampling time (T _s)	When the instruction is scanned, the PID algorithm is implemented according to the sampling time, and the MV is refreshed. If T _s is less than 1, it will be counted as 1. If T _s is larger than 1,000, it will be counted as 1,000. Unit: 100ms	1

6.2.7 Wiring

● Precautions

In order to make the functions of an analog-to-digital module perfect and ensure the reliability of a system at the same time, external wiring which prevents noise is necessary. Before installing cables, users need to follow the precautions below.

- (1) To prevent a surge and induction, an AC cable and input signal cables which are connected to AS04TC-A must be separate cables.
- (2) A cable must not be installed near a main circuit, a high-voltage cable, or a cable connected to a load which is not a PLC. Besides, a cable must not be bound to a main circuit, a high-voltage cable, or a cable connected to a load which is not a PLC. Otherwise, effects that noise, induction, and a surge have will increase.
- (3) Please connect a shielded cable and a hermetically sealed cable with the ground separately.
- (4) Terminals with insulation sleeves can not be arranged as a terminal block. It is recommended that the terminals be covered with insulation tubes.

● External wiring

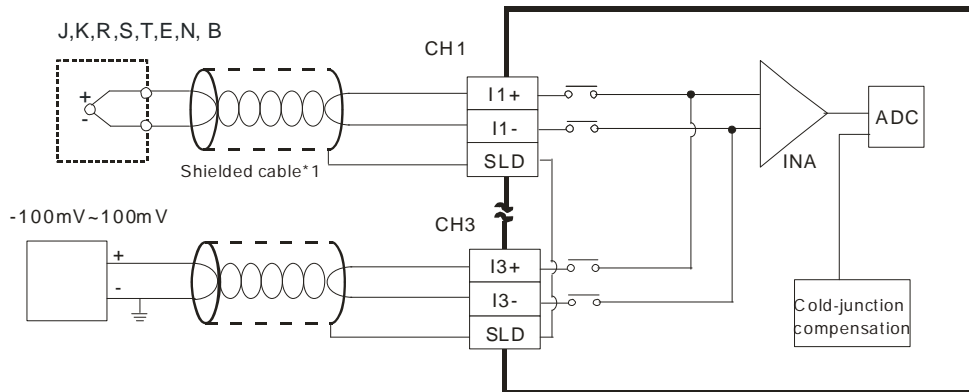

*1. The cables or the shielded twisted pair cables for Type J, type K, type R, type S, type T, type E, type N and type B thermocouples are used, and should be kept separate from other power cables and cables which generate noise.

6.2.8 LED Indicators

Number	Name	Description
1	RUN LED indicator	Operating status of the module ON: The module is running. OFF: The module stops running.
2	ERROR LED indicator	Error status of the module ON: A serious error occurs in the module. OFF: The module is normal. Blink: A slight error occurs in the module.
3	Digital to analog conversion indicator	Indicating the digital to analog conversion status Blinking: conversion is taking place OFF: stop conversion

6

6.3 HWCONFIG in ISPSOft

6.3.1 Initial Setting

- (1) Start ISPSOft, and then double-click **HWCONFIG**.

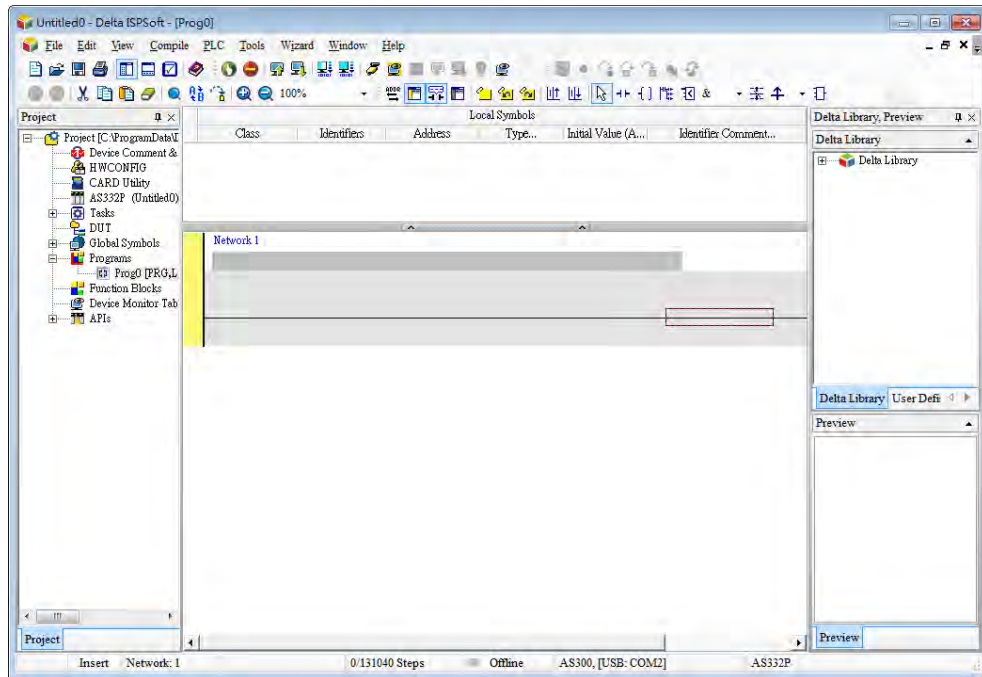

- (2) Selecting a module.

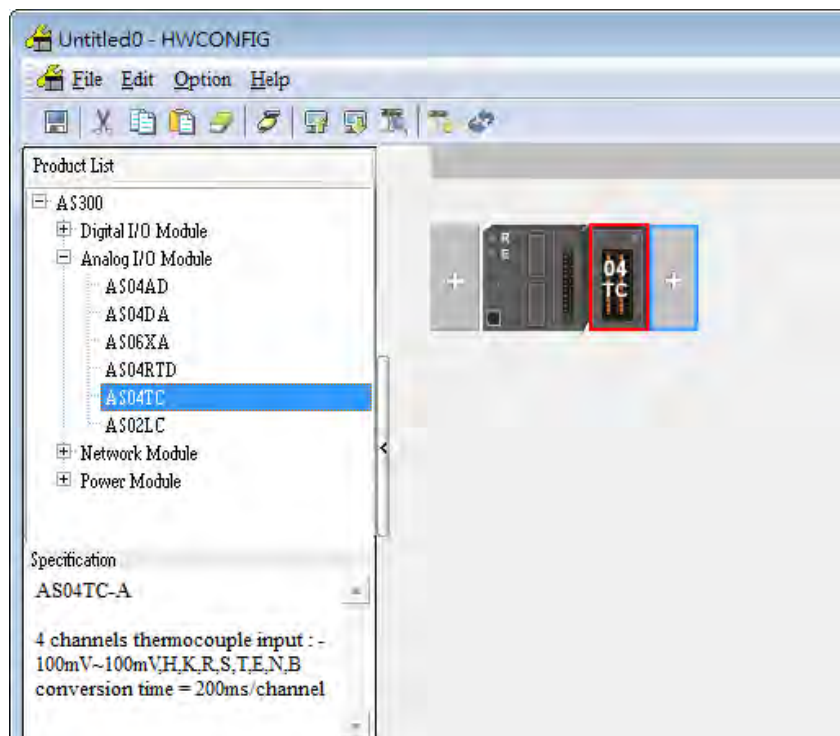

(3) Double-click the module to open the Device Setting page.

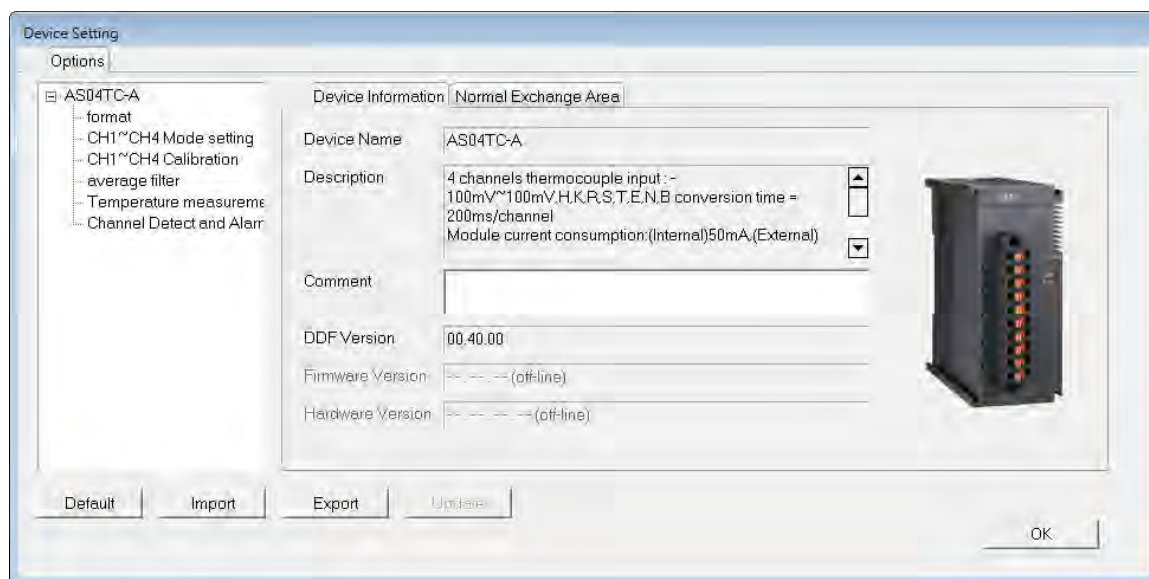
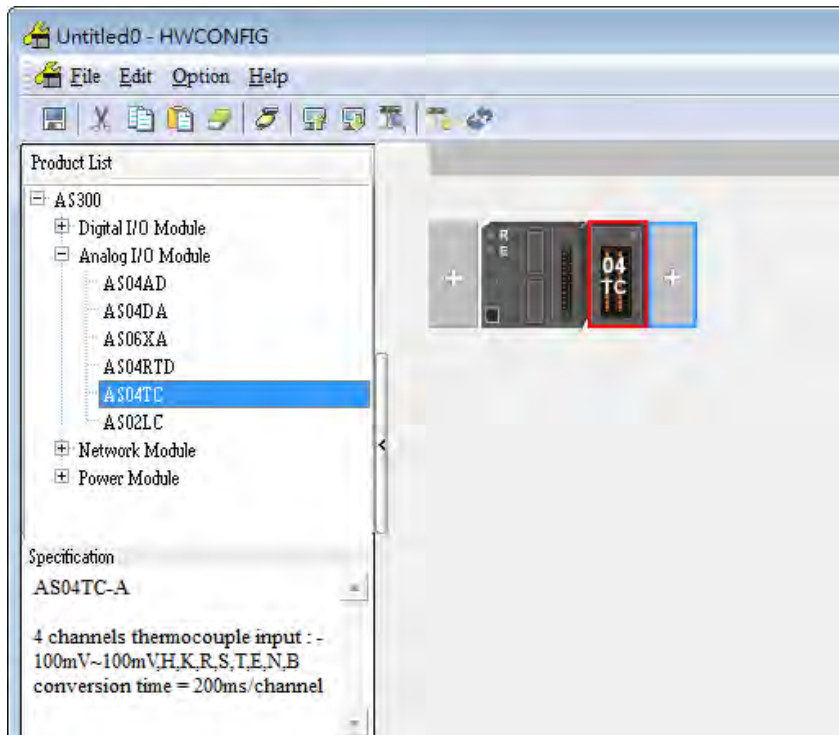

6

(4) Set the parameters, and then click **OK**.

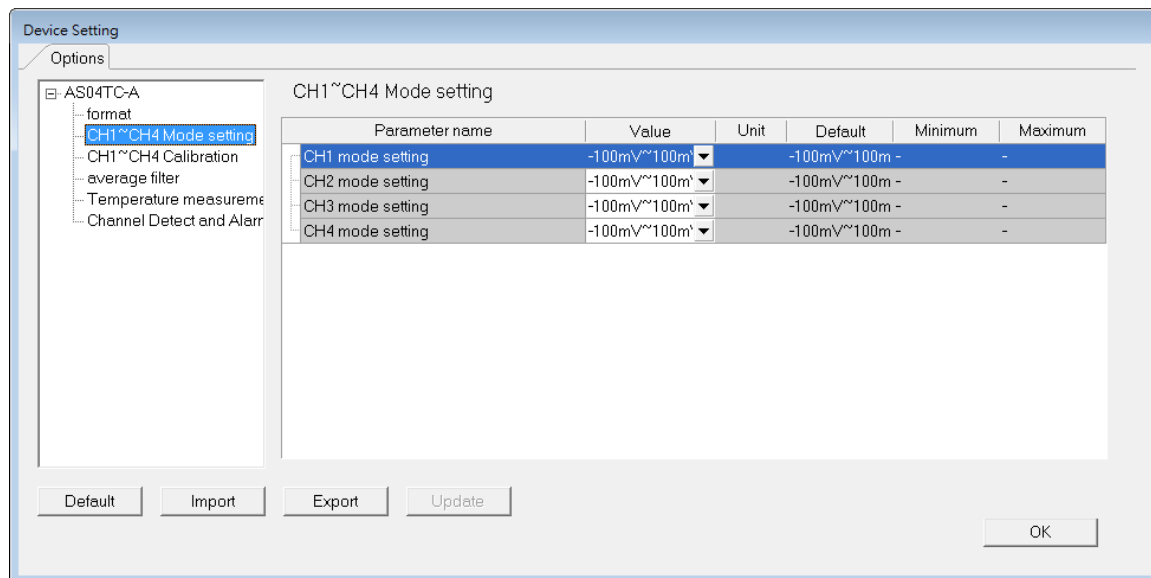

(5) Click **Download** on the toolbar to download the parameters. (The parameters can not be downloaded when the CPU module runs.)

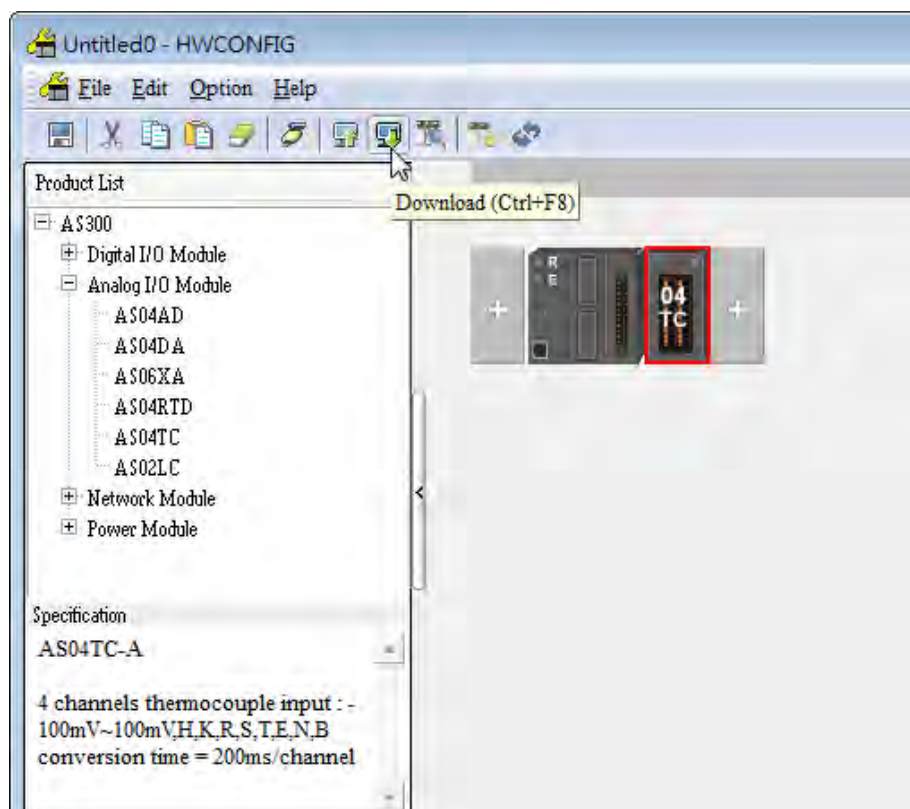

6.3.2 Checking the Version of a Module

(1) On the **Option** menu, click **Online Mode**.

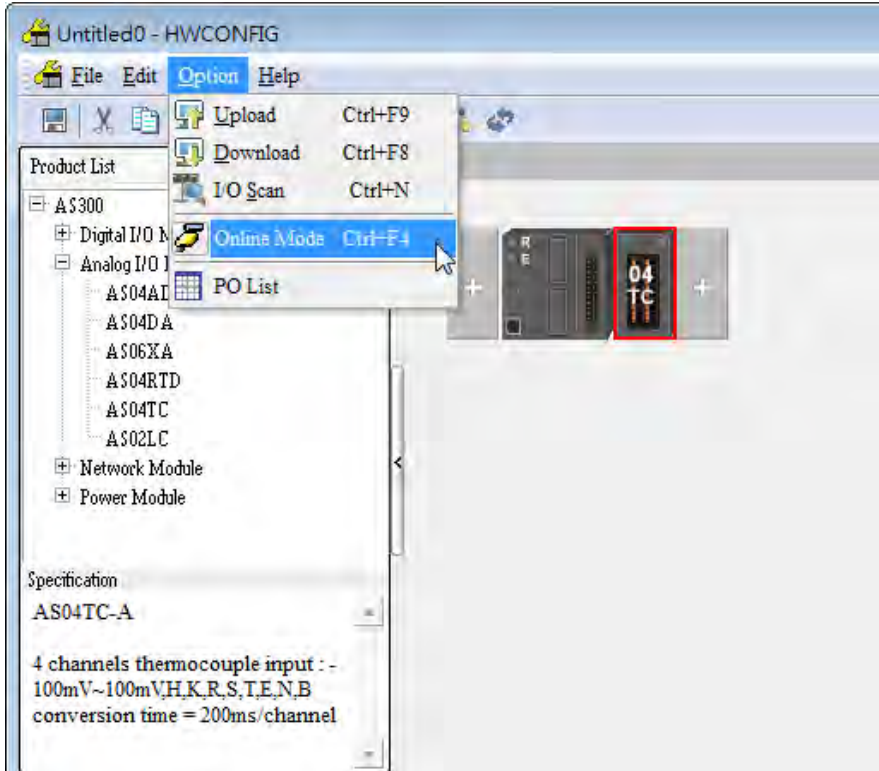

(2) Double-click the module to see the Device Setting page. The version of the firmware and that of the hardware are displayed.

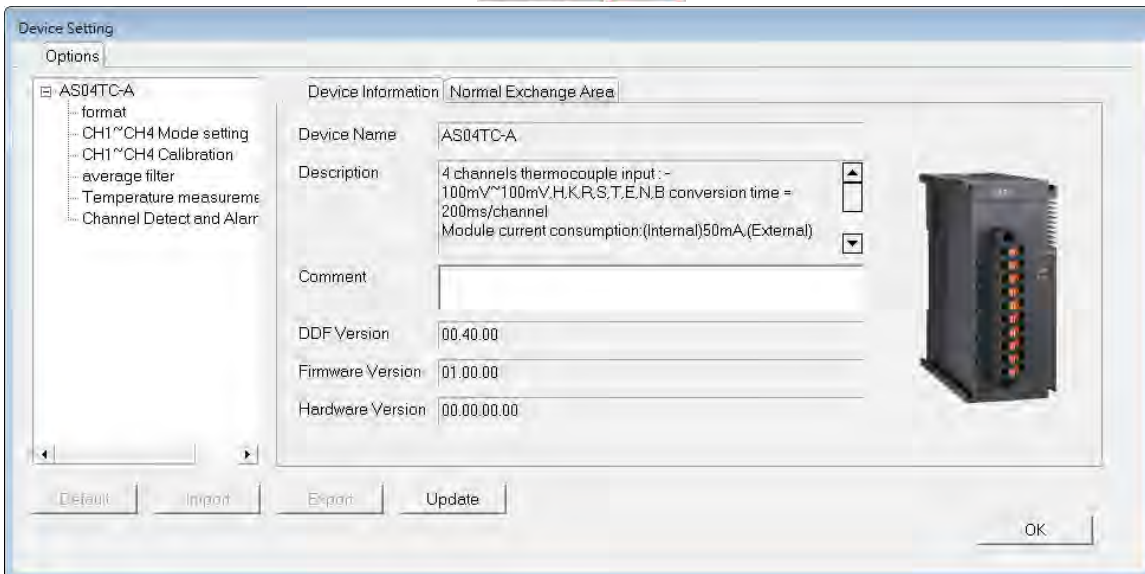

6.3.3 Online Mode

- (1) Click **Online Mode** on the toolbar.

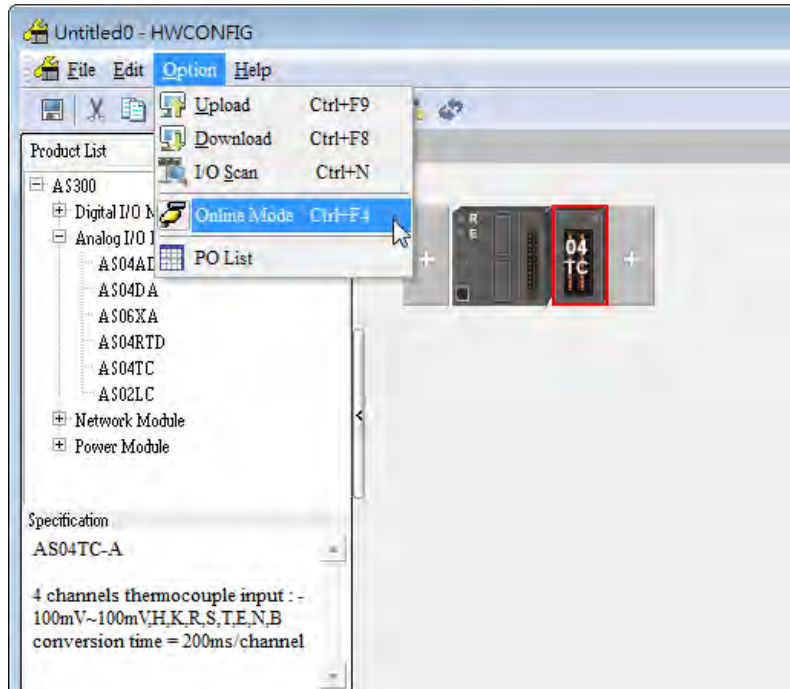

- (2) Right-click the module.

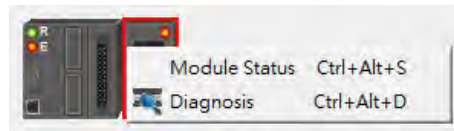

- (3) The module status can be shown.

Channel	Value (32 bits)	Data Type
Error code	6145	DECIMAL
CH1 Input	0	DECIMAL
CH2 Input	0	DECIMAL
CH3 Input	0	DECIMAL
CH4 Input	0	DECIMAL

6.3.4 Importing/Exporting a Parameter File

(1) After **Export** is clicked, the parameters will be saved as a CSV file (.csv).

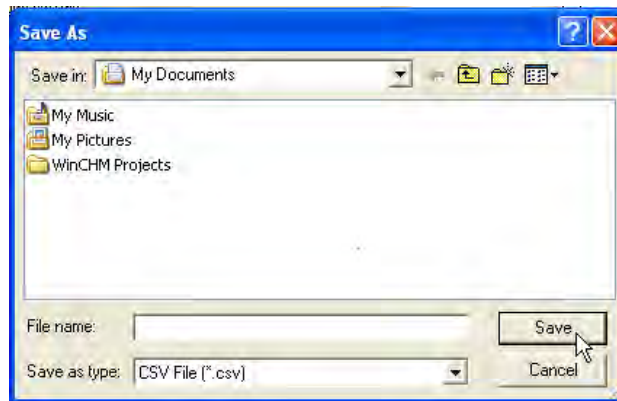

(2) Click **Import**, and then select the CSV file.

6

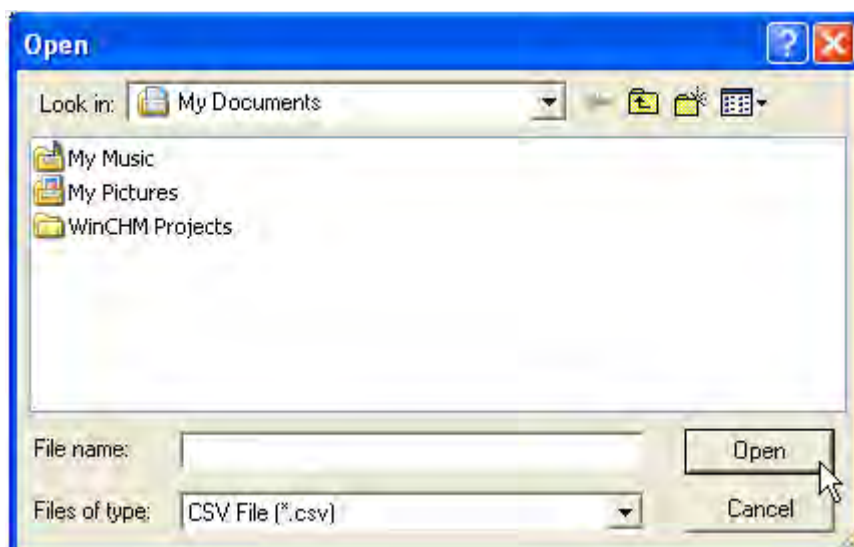
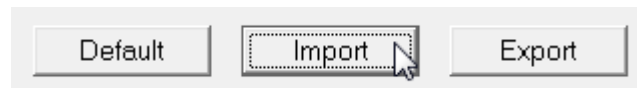

6.3.5 Parameters

(1) The input modes of the channels

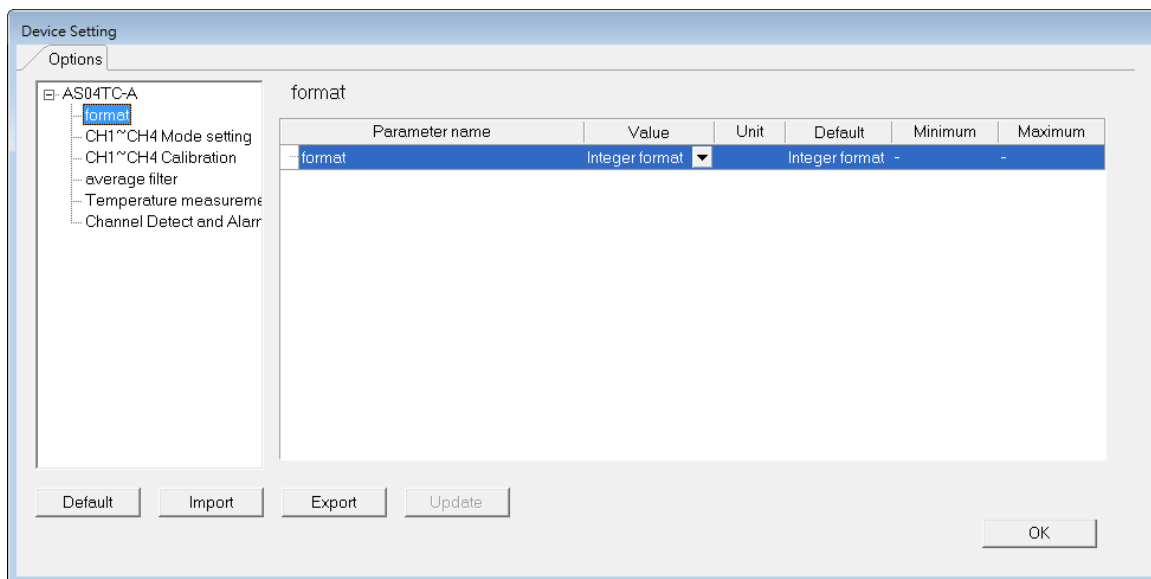

(2) Input CH1~CH4 Mode settings

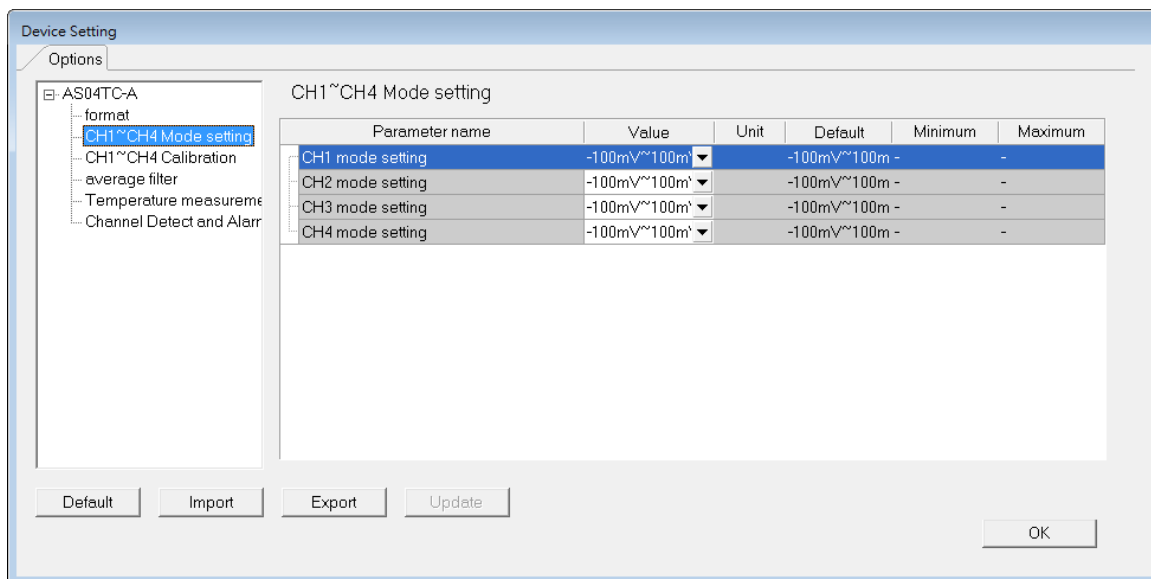

(3) Input CH1~CH4 calibration

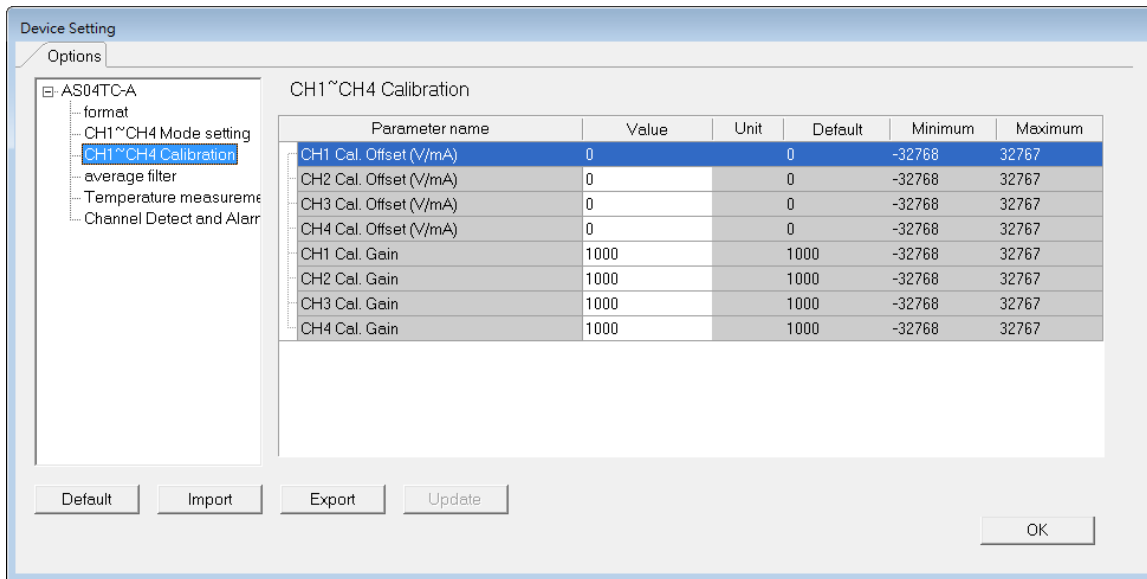

(4) Input average filter

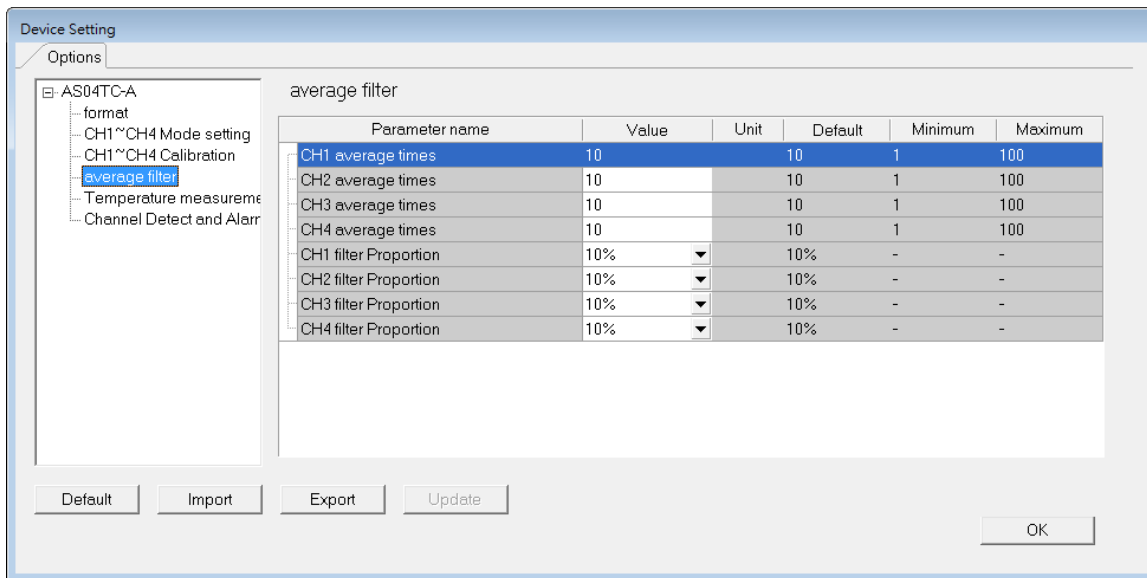

(5) Temperature measurement

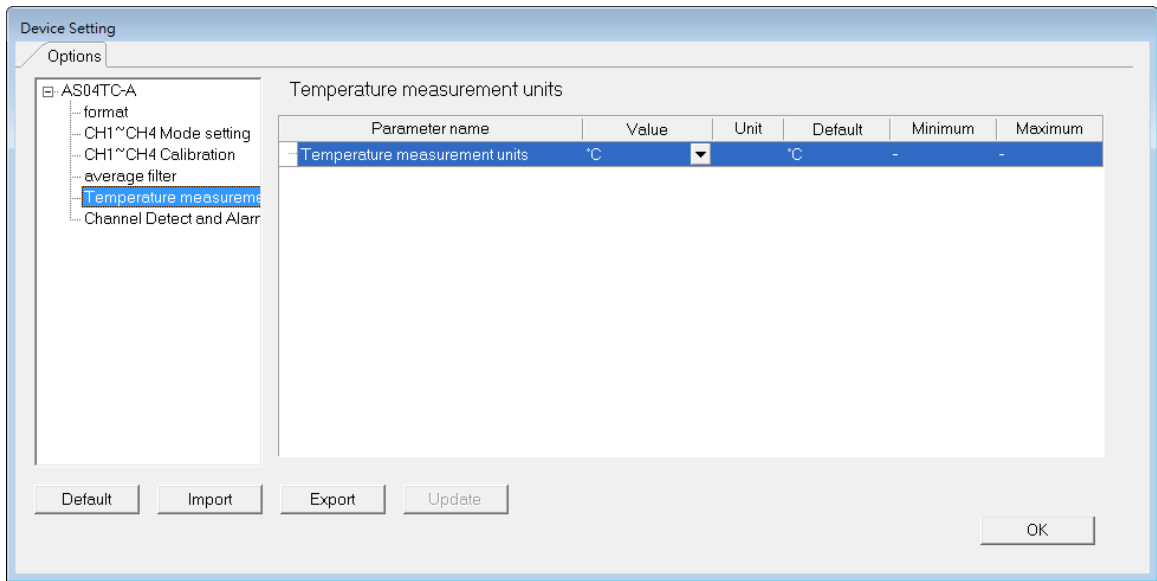

(6) Input channel detect and alarm settings

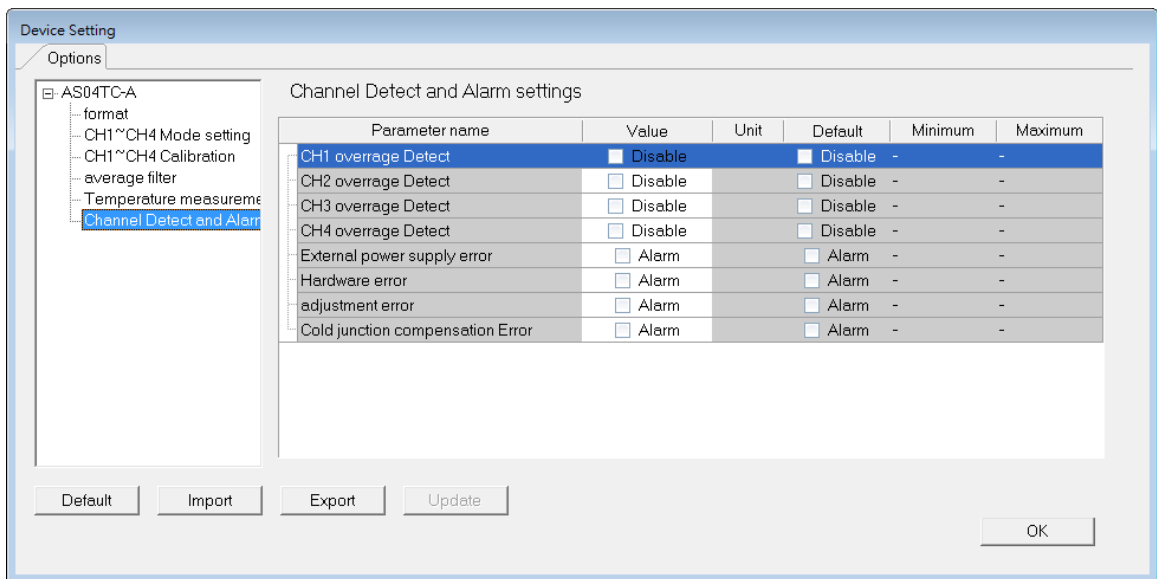

6.4 Troubleshooting

6.4.1 Error Codes

Error Code	Description	A↔D LED indicator	ERROR LED indicator
16#1605	Hardware failure	OFF	ON
16#1607	The external voltage is abnormal.	OFF	ON
16#1608	The factory calibration is abnormal.	OFF	ON
16#1801	The external voltage is abnormal.	OFF	Blinking
16#1802	Hardware failure	OFF	Blinking
16#1804	The factory calibration is abnormal.	OFF	Blinking
16#1808	The signal received by channel 1 exceeds the range of inputs which can be received by the hardware.	Run: blinking Stop: OFF	Blinking
16#1809	The signal received by channel 2 exceeds the range of inputs which can be received by the hardware.		
16#180A	The signal received by channel 3 exceeds the range of inputs which can be received by the hardware.		
16#180B	The signal received by channel 4 exceeds the range of inputs which can be received by the hardware.		

6.4.2 Troubleshooting Procedure

Description	Procedure
The external voltage is abnormal.	Check whether the external 24 V power supply to the module is normal.
Hardware failure	Return the module to the factory for repair.
Internal error The factory correction is abnormal.	Please contact the factory.
The signal received by channel 1 exceeds the range of inputs which can be received by the hardware.	Check the signal received by channel 1
The signal received by channel 2 exceeds the range of inputs which can be received by the hardware.	Check the signal received by channel 2.
The signal received by channel 3 exceeds the range of inputs which can be received by the hardware.	Check the signal received by channel 3.
The signal received by channel 4 exceeds the range of inputs which can be received by the hardware.	Check the signal received by channel 4.

MEMO

Chapter 7 Load Cell Module AS02LC

Table of Contents

7.1	Overview	7-2
7.2	Specifications	7-2
7.2.1	Specifications	7-2
7.2.2	Profile.....	7-3
7.2.3	Arrangement of Terminals.....	7-4
7.2.4	Control Registers	7-4
7.2.5	Functions.....	7-11
7.2.6	Wiring	7-16
7.3	Adjustment.....	7-18
7.3.1	Steps in adjusting points.....	7-18
7.3.2	Adjustment settings / LC Wizard.....	7-19
7.3.3	Adjustment settings / Instructional calibration.....	7-23
7.3.4	LED Indicators.....	7-26
7.4	HWCONFIG in ISPSOft	7-27
7.4.1	Initial Setting	7-27
7.4.2	Checking the Version of a Module	7-29
7.4.3	Online Mode	7-30
7.4.4	Importing/Exporting a Parameter File.....	7-31
7.4.5	Parameters	7-32
7.5	Troubleshooting	7-35
7.5.1	Error Codes.....	7-35
7.5.2	Troubleshooting Procedure.....	7-35

7.1 Overview

The specifications for a load cell module, the operation, and the programming are described in this chapter. A load cell module AS02LC is applicable to 4-wire or 6-wire load cells with various eigenvalues. Therefore, its response time can be adjusted according to users' requirements. On this basis, the requirements of load application markets can be easily met. Moreover AS02LC-A can read and write data via AS series PLC by means of the instruction FROM/TO. To ensure that the product is correctly installed and operated, users need to read the manual carefully before they use. This manual only provides functional specifications, and introduces installation, basic operation and setting. User can refer to load cell related literature for more details on the principle of operation of a load cell.

7.2 Specifications

7.2.1 Specifications

Load cell module	Voltage output
Rated supply voltage/Power consumption	24 VDC (-15 to +20%)/5 W
Minimum/maximum voltage	18~31.2VDC
Maximum current consumption	150 mA
Input signal range	±40mVDC
Sensibility	+5 VDC +/-10%
Highest precision	0.04%
Communication interface	RS-232, RS-485
Applicable sensor type	4-wire or 6-wire load cell
Expanding a temperature coefficient	≤ ± 50 ppm/K v. E
Reducing a temperature coefficient to zero	≤ ± 0.4 μV/K
Linearity error	≤ 0.02%
Response time	2.5, 10, 16, 20, 50, 60, 100, 200, and 400ms
Eigenvalue applicable to a load cell	0~1, 0~2, 0~4, 0~6, 0~20, 0~40 and 0~80 mV/V
Maximum distance for connecting a load cell	100 meters
Maximum output current	5 VDC * 160 mA
Allowable load	40~4,010 Ω
Common-mode rejection ratio (CMRR @50/60 Hz)	≥100 dB
Dyanmic filter	K1~K5
Average weights	K1~K100
Isolation	Between a digital circuit and the ground: 500 V AC Between an analog circuit and the ground: 500 V AC Between an analog circuit and a digital circuit: 500 V AC

7.2.2 Profile

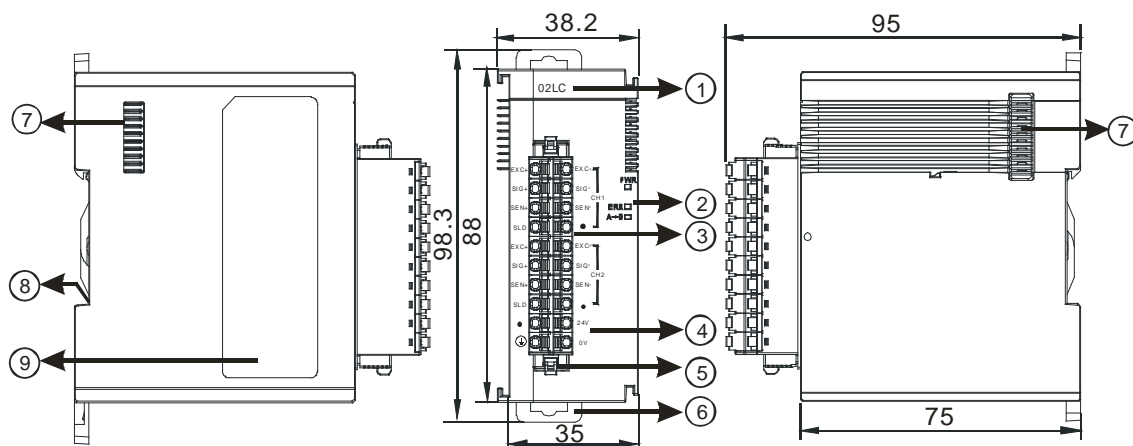

Unit: mm

Number	Name	Description
1	Model name	Model name of the module
2	RUN LED indicator	Operating status of the module ON: The module is running. OFF: The module stops running.
	ERROR LED indicator	Error status of the module ON: A serious error occurs in the module. OFF: The module is normal. Blink: A slight error occurs in the module.
	Digital to analog conversion indicator	Indicating the digital to analog conversion status Blinking: conversion is taking place OFF: stop conversion
3	Removable terminal block	The inputs are connected to transducers. The outputs are connected to loads which will be driven.
4	Arrangement of the input/output terminals	Arrangement of the terminals
5	Clip	Removing the terminal block
6	DIN rail clip	Securing the module onto the DIN rail
7	Module connecting set	Connecting the modules
8	Ground clip	

7.2.3 Arrangement of Terminals

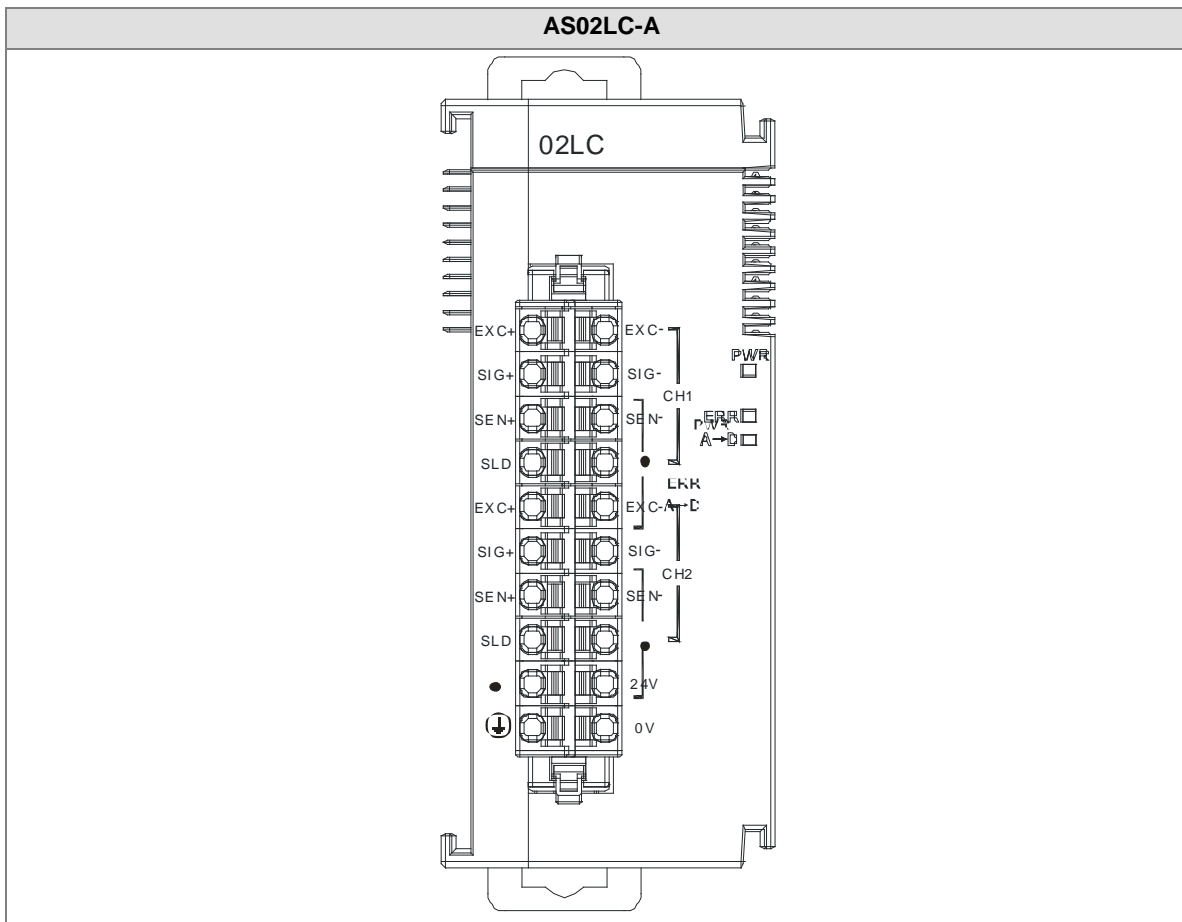

7.2.4 Control Registers

CR#	Name	Description	Defaults
0	Display of the nw/gw for channel 1	0: disabled 1: net weight 2: gross weight	1
1	Eigenvalue setup for channel 1	0 : 1 mV/V 1 : 2 mV/V 2 : 4 mV/V 3 : 6 mV/V 4 : 20 mV/V 5 : 40 mV/V 6 : 80 mV/V	1
2	Sampling cycle setup for channel 1	0 : 2.5ms 1 : 10ms	4

CR#	Name	Description	Defaults
		2 : 16ms 3 : 20ms 4 : 50ms 5 : 60ms 6 : 100ms 7 : 200ms 8 : 400ms	
3	Weight measured times in a stability range setup for channel 1	Setting range: K1 ~ K500	5
4	Stability range setup for channel 1	Floating-point number format; setting range K1~K10000	10
5			
6	Maximum weight setup for channel 1	Floating-point number format; setting the maximum measuring weight; when the weight measured exceeds the limit, an alarm will be triggered. The setting value should be greater than 1.	100,000
7			
8	Filter mode setup for channel 1	0: no filter(default) 1: maximum filter mode 2: average filter mode	0
9	Maximum filter setup for channel 1	Setting range: 0~8, the bigger the number the stronger the filter.	1
10	Average weight measured times for channel 1	Setting range: 1~100	10
11	Upper limit of the zero	Floating-point number format; determining the current weight as the zero point in the upper/lower range; when the lower range is bigger than the upper range, the lower range will be seen as the upper range and vice versa.	10
12	return for channel 1		
13	Lower limit of the zero		-10
14	return for channel 1		
15	Zero point tracking time for channel 1	Setting range: 1~500; unit: 100ms	10
16	Zero point tracking range	Floating-point number format; setting range: 0 ~ 10000; 0: disabled	0
17	for channel 1		
18	Calibration points for channel 1	Setting range: 2~20	2

CR#	Name	Description	Defaults
19~58	Calibrated weight for channel 1	Floating-point number format; calibrated weight of the calibration points 1~20	-
59	Display of the nw/gw for channel 2	0: disabled 1: net weight 2: gross weight	1
60	Eigenvalue setup for channel 2	0 : 1 mV/V 1 : 2 mV/V 2 : 4 mV/V 3 : 6 mV/V 4 : 20 mV/V 5 : 40 mV/V 6 : 80 mV/V	1
61	Sampling cycle setup for channel 2	0 : 2.5ms 1 : 10ms 2 : 16ms 3 : 20ms 4 : 50ms 5 : 60ms 6 : 100ms 7 : 200ms 8 : 400ms	4
62	Weight measured times in a stability range setup for channel 2	Setting range: K1 ~ K500	5
63	Stability range setup for channel 2	Floating-point number format; setting range K1~K10000	10
64			
65	Maximum weight setup for channel 2	Floating-point number format; setting the maximum measuring weight; when the weight measured exceeds the limit, an alarm will be triggered. The setting value should be greater than 1.	100,000
66			
67	Filter mode setup for channel 2	0: no filter(default) 1: maximum filter mode 2: average filter mode	0

CR#	Name	Description	Defaults
68	Maximum filter setup for channel 2	Setting range: 0~8, the bigger the number the stronger the filter.	1
69	Average weight measured times for channel 2	Setting range: 1~100	10
70	Upper limit of the zero return for channel 2	Floating-point number format; determining the current weight as the zero point in the upper/lower range; when the lower range is bigger than the upper range, the lower range will be seen as the upper range and vice versa.	10
71			
72	Lower limit of the zero return for channel 2		-10
73			
74	Zero point tracking time for channel 2	Setting range: 1~500; unit: 100ms	10
75	Zero point tracking range for channel 2	Floating-point number format; setting range: 0 ~ 10000; 0: disabled	0
76			
77	Calibration points for channel 2	Setting range: 2~20	2
78~117	Calibrated weight for channel 2	Floating-point number format; calibrated weight of the calibration points 1~20	-
118	Decimal place setup for channel 1	Setting range: 0~4	1
119	Decimal place setup for channel 2	Setting range: 0~4	1
120	Alarm setup	0: warning 1: alarm Bit1: Error occurs in the module power Bit2: Error occurs in the module hardware Bit3: Error occurs in driver board	0
200	State register	Refer to the explanation below	-
201	Instruction set	Refer to the explanation below	0
210	The maximum peak value for channel 1	Floating-number point format; the maximum peak value for channel 1	-
211			-
212	The maximum peak value for channel 2	Floating-number point format; the maximum peak value for channel 2	-
213			-
214	The minimum peak value	Floating-number point format; the minimum peak	-

CR#	Name	Description	Defaults
215	for channel 1	value for channel 1	-
216	The minimum peak value	Floating-number point format; the minimum peak	-
217	for channel 2	value for channel 2	-
222	The time to record for channel 1	Unit: 1ms, setting range 1~100 (1ms~1s)	50
223	The time to record for channel 2	Setting the time to record the digital value for the channels	50
240	The number of records for channel 1	Range: 0~500, display the current records	-
241	The number of records for channel 2		-
604	Tare measured by channel	Display the tare measured by channel 1	-
605	1		-
606	Tare measured by channel	Display the tare measured by channel 2	-
607	2		-
700~739	Theoretical calibration for channel 1	Floating-number point format; output voltage unit: mV	0
740~779	Theoretical calibration for channel 2	Floating-number point format; output voltage unit: mV	0
4000~4999	Records for channel 1	Floating-number point format; 500 records for channel 1	-
5000~5999	Records for channel 2	Floating-number point format; 500 records for channel 2	-

Normal Exchange Area

[Explanation]

Users can learn the error code, channel value, state code and the data registers which correspond to their instructions in Normal Exchange Area sheet of the Device Setting in HWCONFIG of ISPSOft.

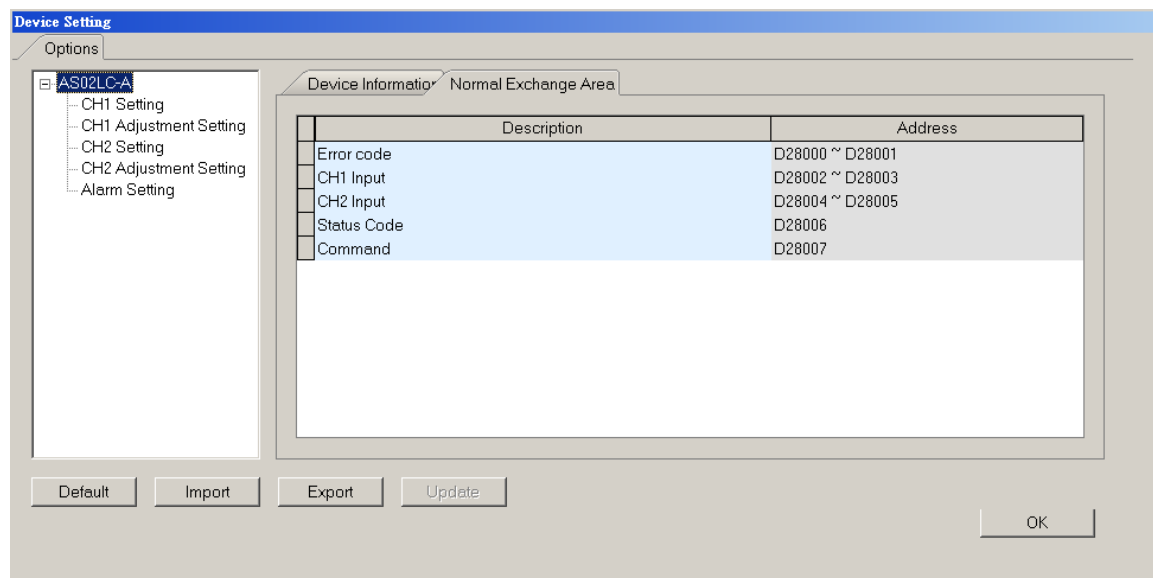

CR#200: Codes for the state register

[Explanation]

Bit	Code	Definition	Bit	Code	Definition
b0	16#0001	Error occurs in the module power	b1	16#0002	Error occurs in the module hardware
b2	16#0004	Error occurs in driver board	b3	16#0008	Calibration disabled
b4	16#0010	Reserved	b5	16#0020	Reserved
b6	16#0040	The weight measured by CH1 exceeds the maximum weight which can be measured, or the voltage of SEN is incorrect.	b7	16#0080	The weight measured by CH2 exceeds the maximum weight which can be measured, or the voltage of SEN is incorrect.
b8	16#0100	The weight measured by CH1 exceeds the maximum weight which can be measured.	b9	16#0200	The weight measured by CH2 exceeds the maximum weight which

Bit	Code	Definition	Bit	Code	Definition
					can be measured.
b10	16#0400	CH1 is adjusted incorrectly.	b11	16#0800	CH2 is adjusted incorrectly.
b12	16#1000	No weight is measured by CH1.	b13	16#2000	No weight is measured by CH2.
b14	16#4000	A weight measured by CH1 is in the stability range specified.	b15	16#8000	A weight measured by CH2 is in the stability range specified.

Note: The state shown is determined by the corresponding bit and it is possible to have more than 2 states at the same time.

CR#201: Instrucion set

[Explanation]

Input value	Description	Input value	Description
0	No action	16#0101	Start a new recording of the peak value for channel 1
1~20	Instucitons for calibrating the calibration points 1~20 in channel 1	16#0102	Start a new recording of the peak value for channel 1
21~40	Instucitons for calibrating the calibration points 1~20 in channel 1	16#010F	Start a new recording of the peak value for channel 1~2
98	Activate the weight calibration	16#0201	Start a new recording for channel 1
99	Inactivate the weight calibration	16#0202	Start a new recording for channel 2
100	Subtracting the tare measured by CH1	16#020F	Start a new recording for channel 1~2
101	Not subtracting the tare measured by CH1	16#0211	Stop recording for channel 1
102	Restoring the weight measured by CH1 to zero	16#0212	Stop recording for channel 1
103	Subtracting the tare measured by CH2	16#021F	Stop recording for channel 1~2
104	Not subtracting the tare measured by CH2	16#0301	Start a theoretical calibration for channels 1

Input value	Description	Input value	Description
105	Restoring the weight measured by CH2 to zero	16#0302	Start a theoretical calibration for channels 2
16#030F	Start a theoretical calibration for channels 1~2	16#0502	Restore to default settings

7.2.5 Functions

Item	Function	Description
1	Measuring a net weight	Various measuring modes for users to choose from.
2	Stability check	When an object is put on a load cell, users can check whether the present weight of the object is in a stability range specified.
3	Determining zero	If an object is removed from the load cell used, no weight is measured.
4	Filtering out weights	Filtering out the maximum/minimum weight measured or using a averaging weight for a more accurate value
5	Multi-point adjustment	Up to 20 points adjustment
6	Theoretical calibration	Calibration according to the output value of the sensor instead of the real weight calibration
7	Zero point tracking	Zero point tracking
8	The limit detections for channels	Saving the maximum/minimum values for channels
9	Records for channels	Saving the analog curves for channels

1. Measuring a net weight

Users can choose to measure the net weight or the gross weight of an object. A net weight is the weight of a product, that is, the actual weight of a product without its package. The weight of a package is a tare. A gross weight is a total weight, namely a net weight plus a tare.

- Tare: A tare is the weight of a package
- Net weight: A net weight is the weight of a product, that is, the actual weight of a product without its package.

- Gross weight: A gross weight is a total weight, namely the weight of a product itself (a net weight) plus the weight of a package (a tare).
- Gross weight=Net weight+Tare

Example: A product weighs 10 kilograms, and the carton in which the product is packed weighs 0.2 kilograms. The total weight gotten is 10 kilograms.

Net weight=10 kg

Tare=0.2 kg

Gross weight=10.2 kg

2. Stability check

When an object is put on a load cell, users can check whether the present weight of the object is in a stability range specified.

- If a weight measured is in a stability range specified by users, the corresponding bit will be set to 1.
- If a weight measured exceeds a range specified by users, the corresponding bit will be set to 0 until the number of weights measured in a stability range reaches the value set.

Example: The measurement time set is 10 milliseconds, the number of weights measured in a stability range is 10, and the stability range set is 1000 grams. If a variation exceeds 1000 grams, the corresponding bit will be set to 0. If the variations in 100 milliseconds (10x10 ms) are within 1000 grams, the corresponding bit will be set to 1. (Users should judge whether the present weight measured is in the stability range set before they perform control.)

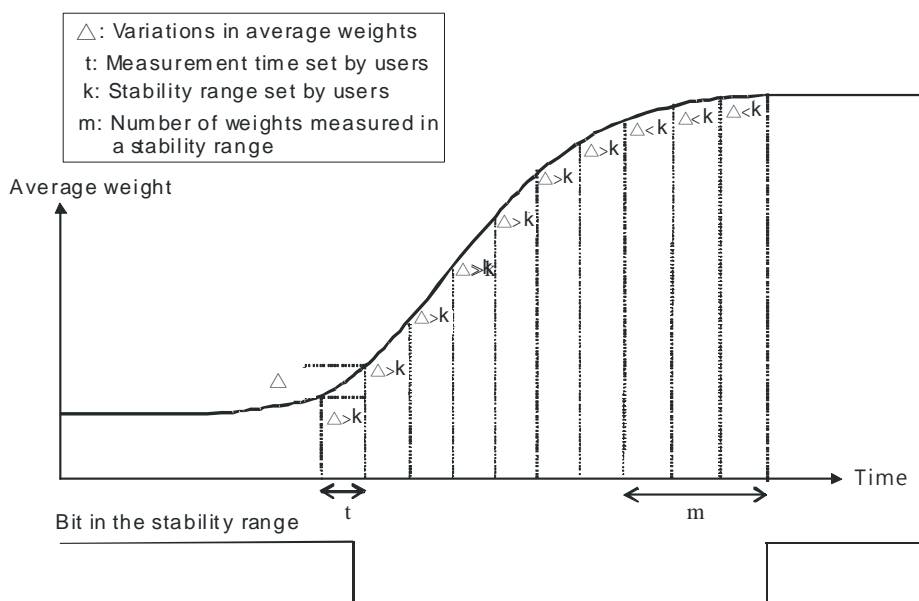

3. Determining zero point

If an object is removed from the load cell used, the corresponding bit will be set to 1, the corresponding bit will be set to 1, and users can perform the next control. (If a weight measured is in the zero range specified, the corresponding bit will be set to 1.)

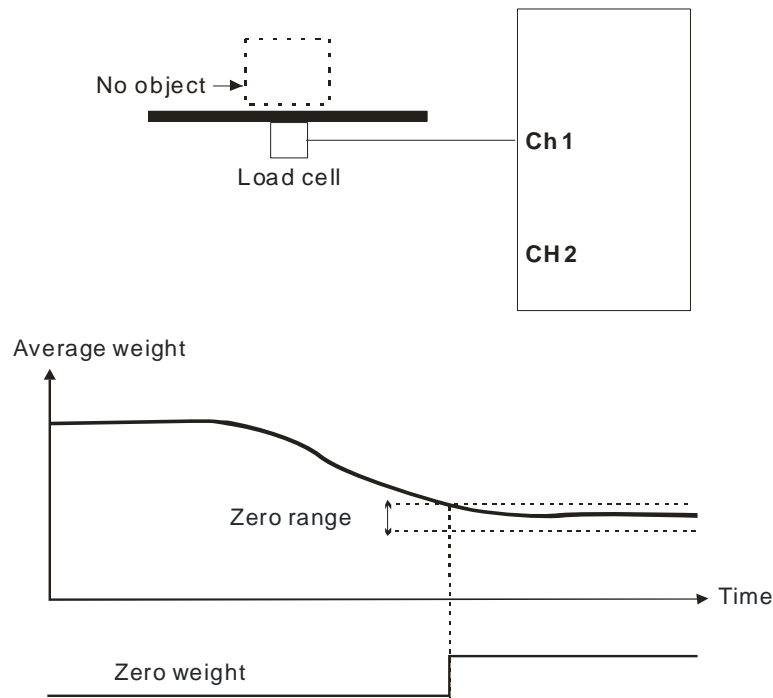

4. Filtering out weights

There are two ways to filter out weights.

- Filtering out the maximum/minimum weight measured: If there is a maximum weight or a minimum weight, users can filter out the maximum weight or the minimum weight. If the value set is bigger, more weights will be filtered out. Setting range: K0~K8
- Averaging weights: The values read are averaged so that a steady value is obtained. There may be peak values due to unavoidable external factors, and the average value obtained changes accordingly. The maximum number of values which can be averaged are 100.

5. Multi-point adjustment

The purpose of making adjustment is to make the weight measured by a cell correspond to the digital value displayed in a load cell module. Generally, two points are adjusted. After a system is set up, users can put no load on the scale. The weight measured is 0 grams when no load is put on the scale. The users can put a given weight on the scale, and set a digital value corresponding to the weight. The two points are adjusted. For example, if a load cell sensor which can measure a maximum weight of 10 kg is used, and 1 kg corresponds to K1000, the curve presented will be like the one shown below.

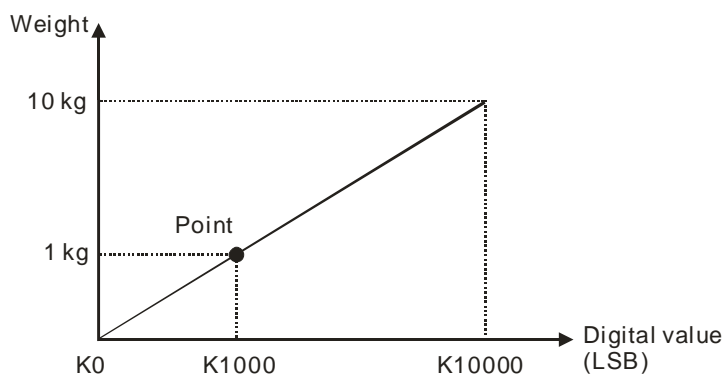

Adjusting two points

In addition to the adjustment of two points, a load cell supports the adjustment of multiple points (20 points at most). A characteristic curve is shown below.

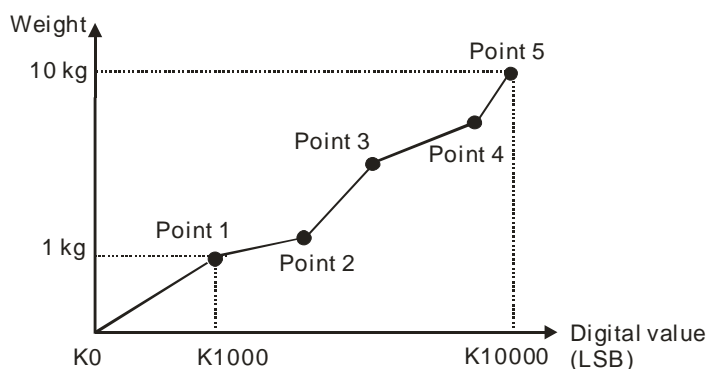

Adjusting multiple points

6. Theoretical calibration

Theoretical calibration is done according to the sensor specification to input the voltage value to correspond to weights. The registers for storing the voltage value are CR#700~739 for channel 1 and CR740~779 for channel 2. After the voltage values are inputted in the registers, users can use the instruction set 16#301~302 to execute the calibration.

Example: The sensor specification is 10Kg and its eigenvalue is 2mV/V. When the sensor is loaded with a 10Kg weight, the output is 10mV. The theoretical calibration steps are as below:

Step 1: Set up the eigenvalue.

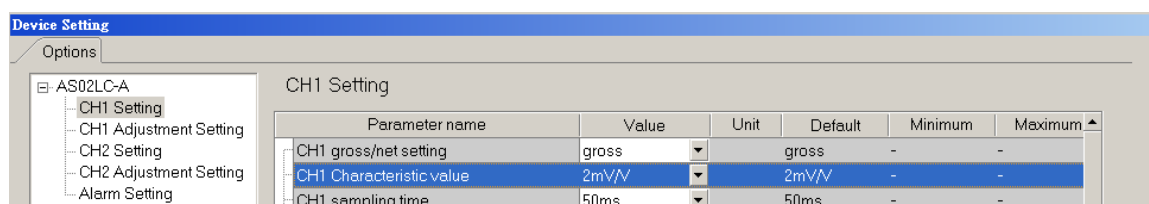

Step 2: Set up 2-point adjustment; when the sensor is loaded with a 10Kg weight, set up the value to 10.

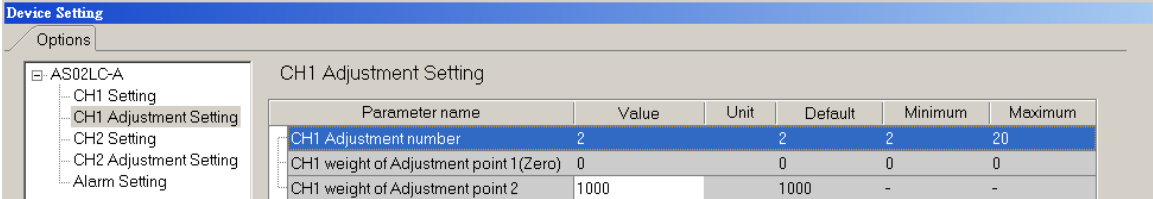

The screenshot shows the 'Device Setting' interface for 'AS02LC-A'. The 'Options' menu is open to 'CH1 Adjustment Setting'. A table displays the following parameters:

Parameter name	Value	Unit	Default	Minimum	Maximum
CH1 Adjustment number	2		2	2	20
CH1 weight of Adjustment point 1 (Zero)	0		0	0	0
CH1 weight of Adjustment point 2	1000		1000	-	-

Step 3: Set up the voltage calibraiton for the zero point to 0 (0mV) in the CR#700/701, and to 10.0 (10mV) in the CR702/703.

Step 4: Write 16#0301 into the instruction set CR#201 to execute a theoretical calibration for channels 1.

Step 5: Do not put any load on the sensor and write 16#102 into the instruction set CR#201 to reset the value to 0 for channel 1.

7. Zero-point tracking

Zero-point tracking means resetting the current value to 0. Users can reset the value to 0 within certain duration or weight. This is especially useful when the senso is not as accurated as before.

8. The limit detections for channels

Saving the maximum/minimum values for channles and users can know the peak to peak value from the maximum/minimum values

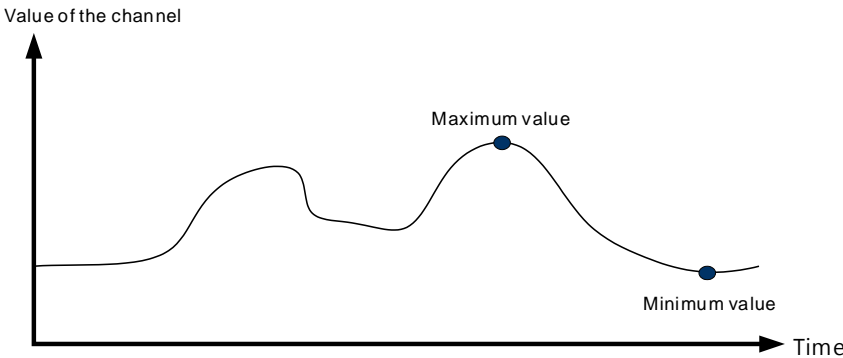

9. Records for channels

Record the input value of the cyclic sampling for each channel, up to 500 pieces can be recorded and the recording time is 10ms.

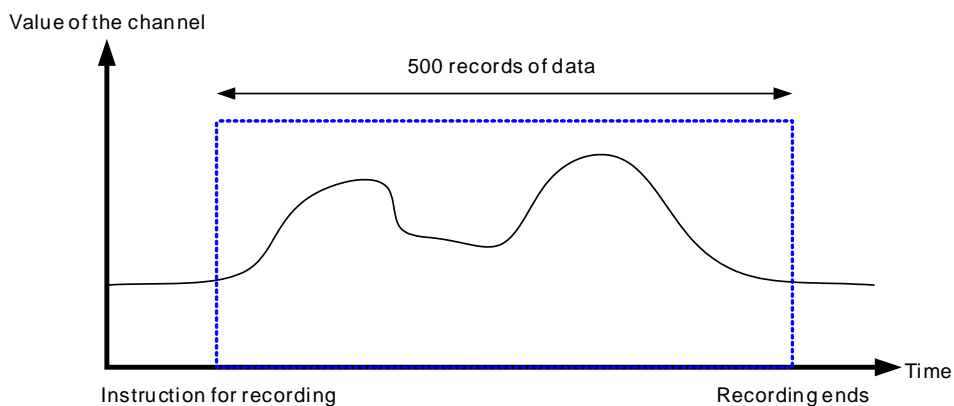

7.2.6 Wiring

- External wiring

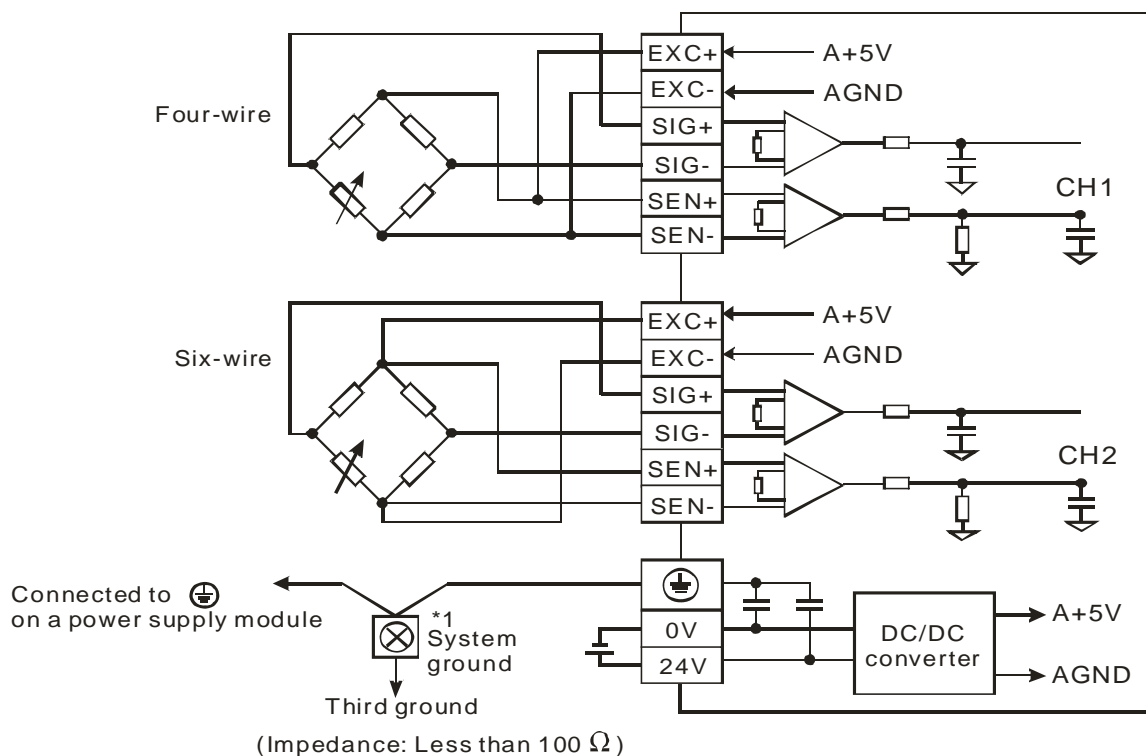

7

- Multiple load cells connected in parallel are connected to a single load cell module.

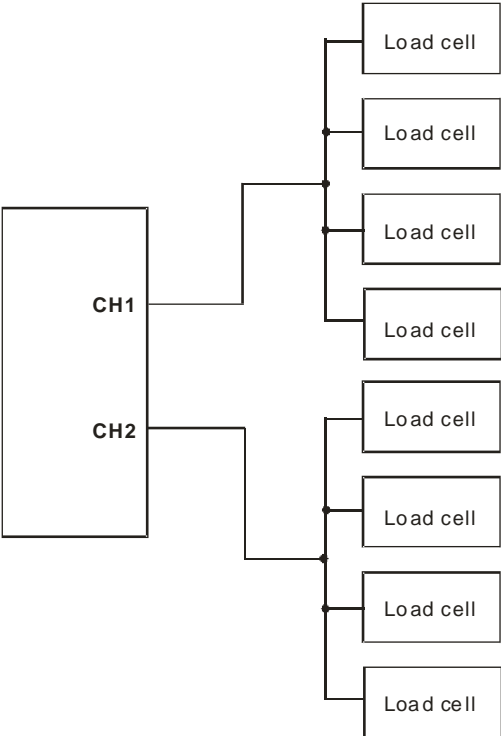

Note 1: Please connect \oplus on a power supply module and \oplus on the load cell module to a system ground, and then ground the system ground or connect the system ground to a distribution box.

Note 2: If multiple load cells are connected in parallel, the total impedance should be greater than 40 Ω .

7.3 Adjustment

The purpose of making adjustment is to make the weight measured by a cell correspond to the digital value displayed in a load cell module. The adjustment can be done via the instructions related or via the theoretical calibration (refer to section 7.2.5 for more details). The adjustment steps are shown as below.

7.3.1 Steps in adjusting points

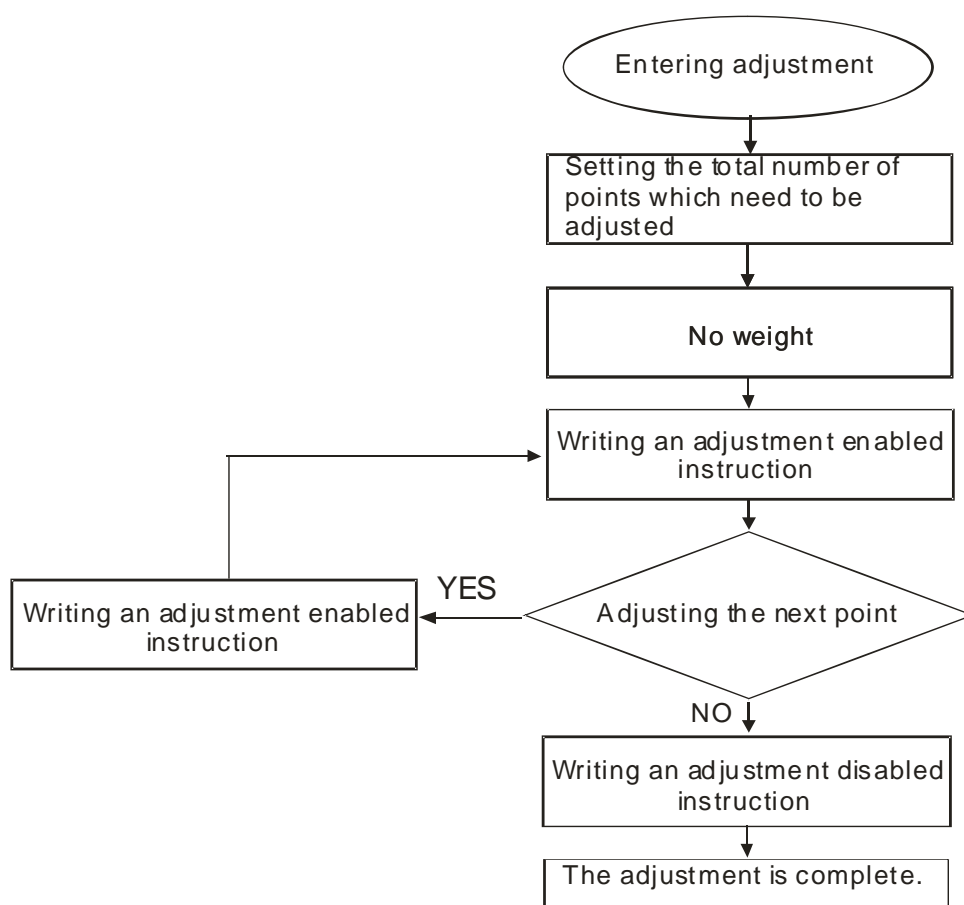

7.3.2 Adjustment settings / LC Wizard

Step 1: Set up the eigenvalue in HWCONFIG of ISPSOfot

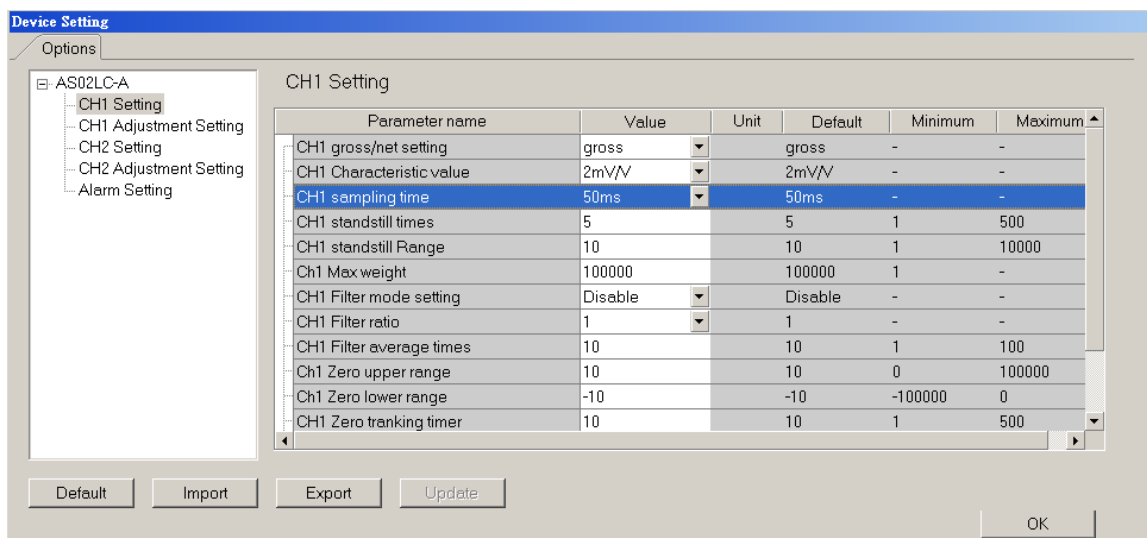

Step 2: Set up the number of adjustment and its corresponding value; the example is a 2-point adjustment, point 1 is 0 and the value for point 2 is 1000, corresponding to 1Kg.

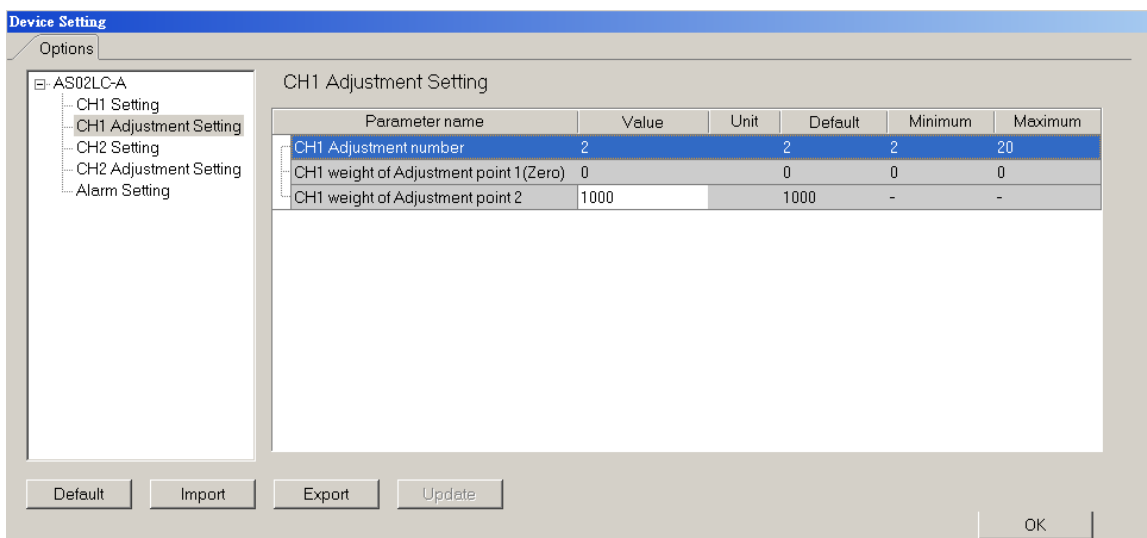

Step 3: After the configuration is done, download the parameters to the module

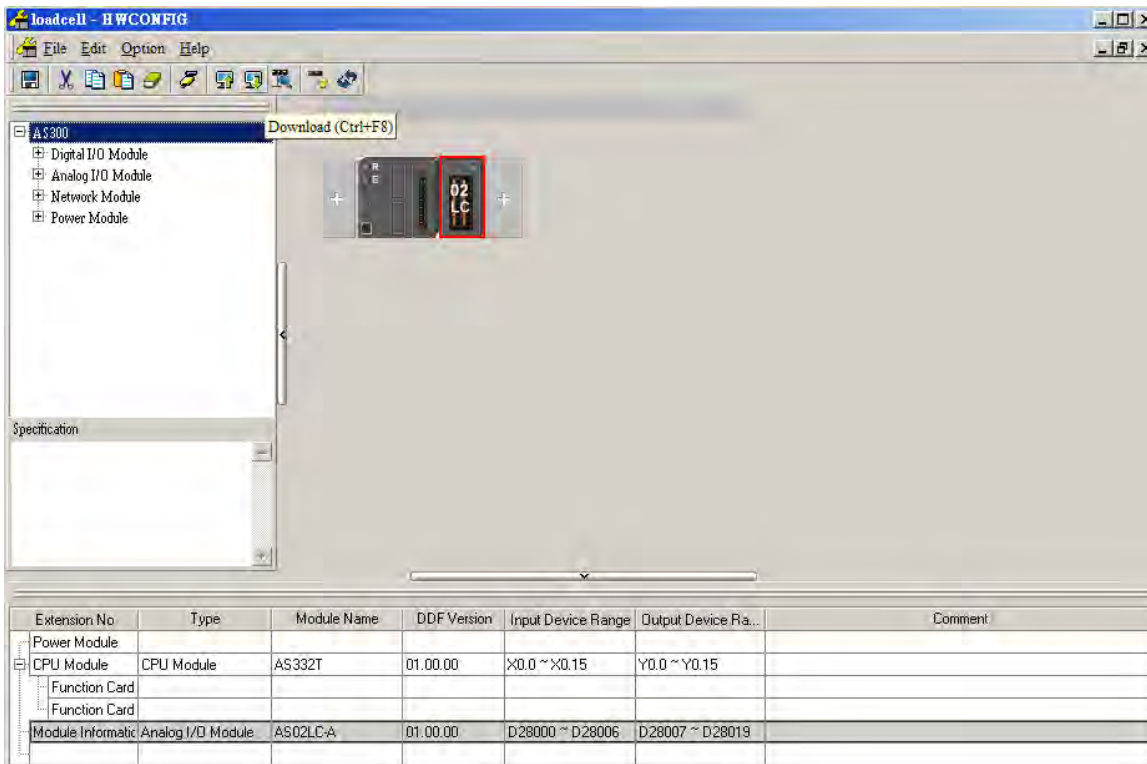

Step 4: Right click on the module to see the option LC Wizard and double-click to open the LC Wizard.



Step 5: Make sure the channel and adjusted points shown are the same as you have set.

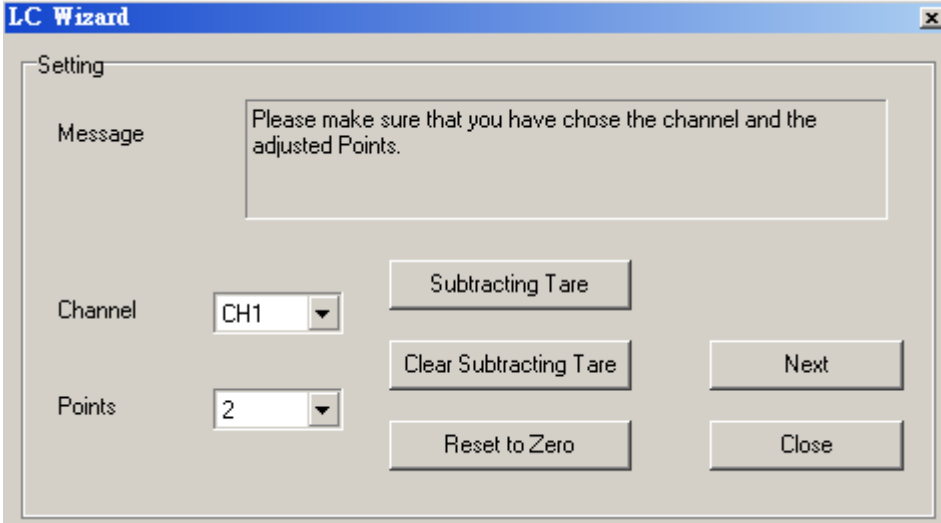

Step 6: Put no load on the load cell (adjustment point 1). And click "Next" to proceed.

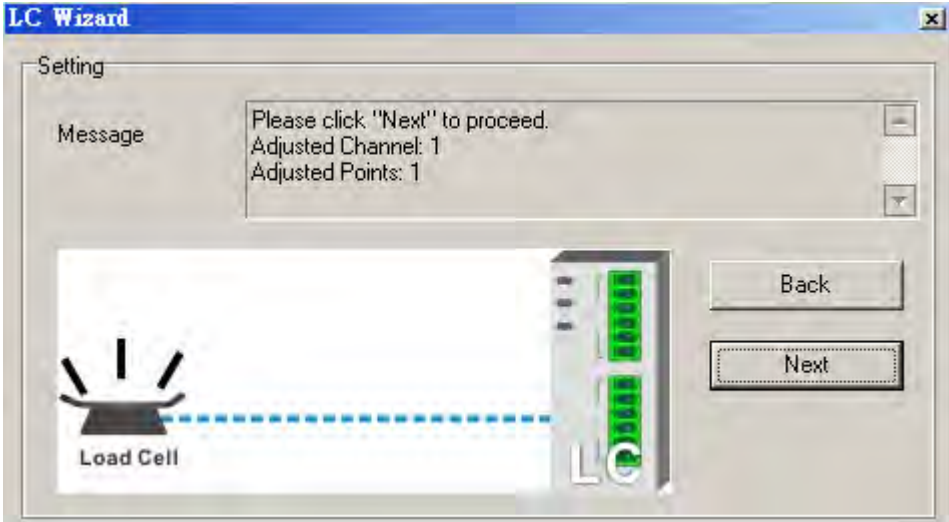

Step 7: Put a load on the load cell (adjustment point 2). For multi-point adjustment, repeat this step. This example uses a 1Kg.

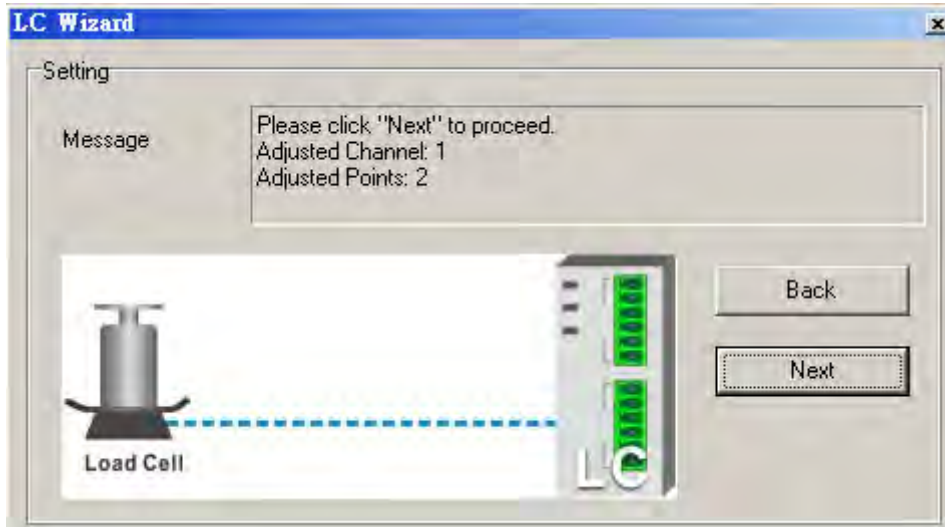

Step 8: The calibration is done.

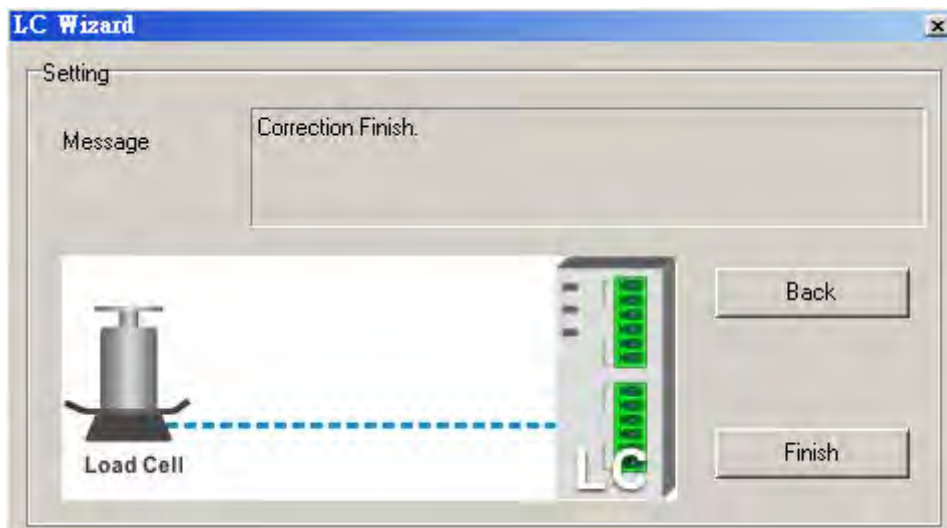

A characteristic curve is shown below.

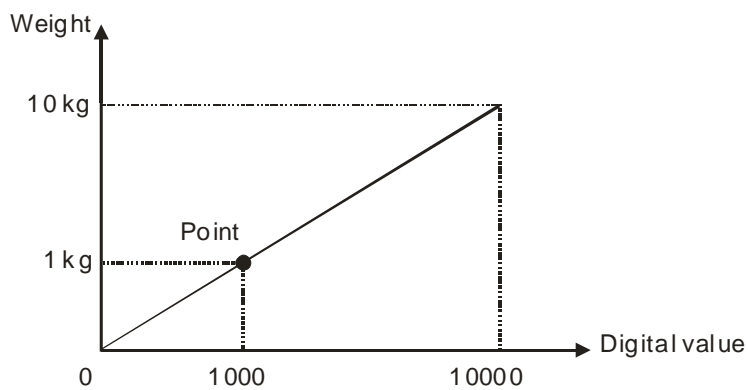

Adjusting two points

7.3.3 Adjustment settings / Instructional calibration

Step 1: Set up the eigenvalue in HWCONFIG of ISPSOfot

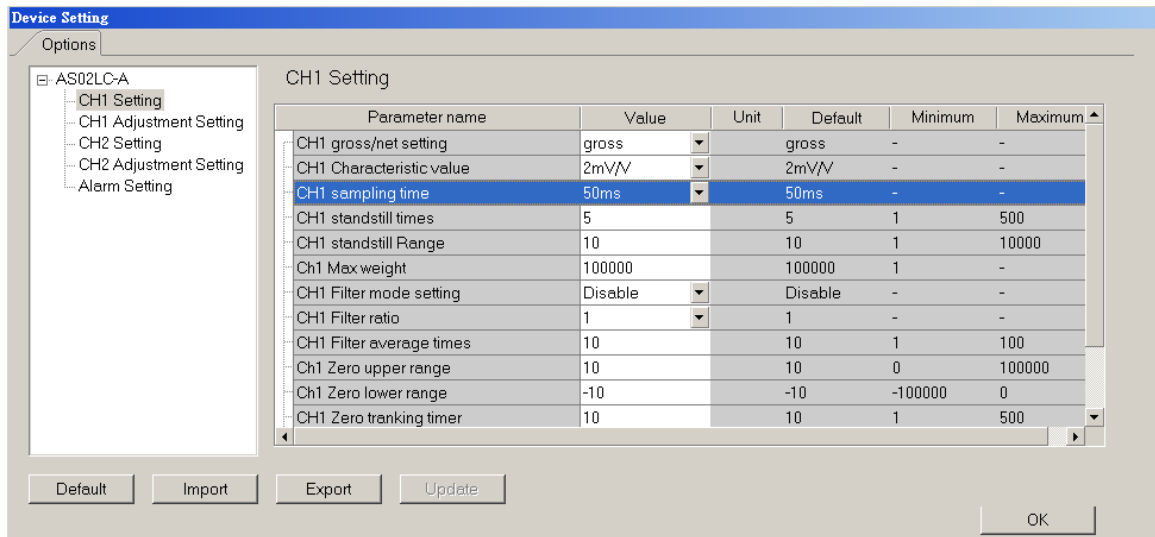

Step 2: Set up the number of adjustment and its corresponding value; the example is a 2-point adjustment, point 1 is 0 and the value for point 2 is 1000, corresponding to 1Kg.

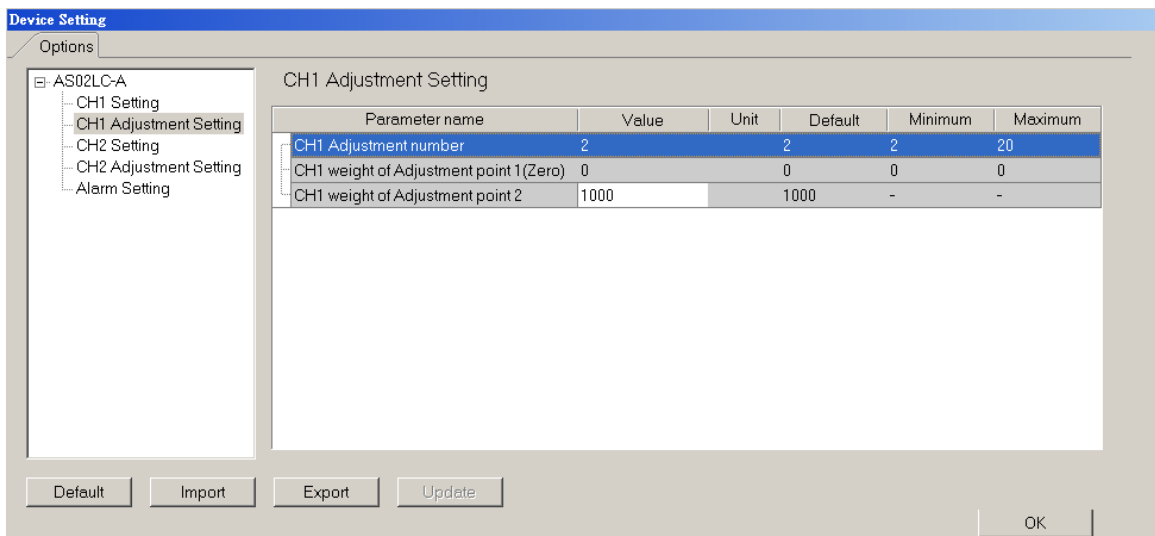

Step 3: After the configuration is done, download the parameters to the module

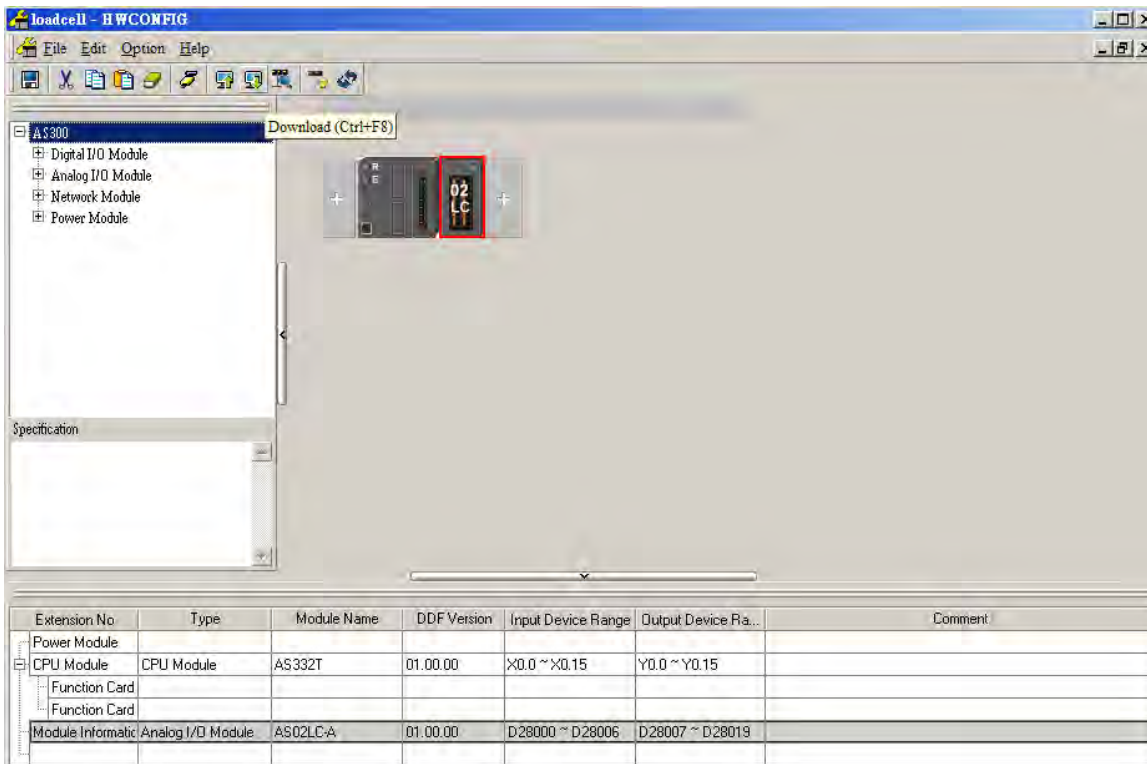

Step 4: Users can see the corresponding address for instruction is D28007 in the Normal Exchange Area.

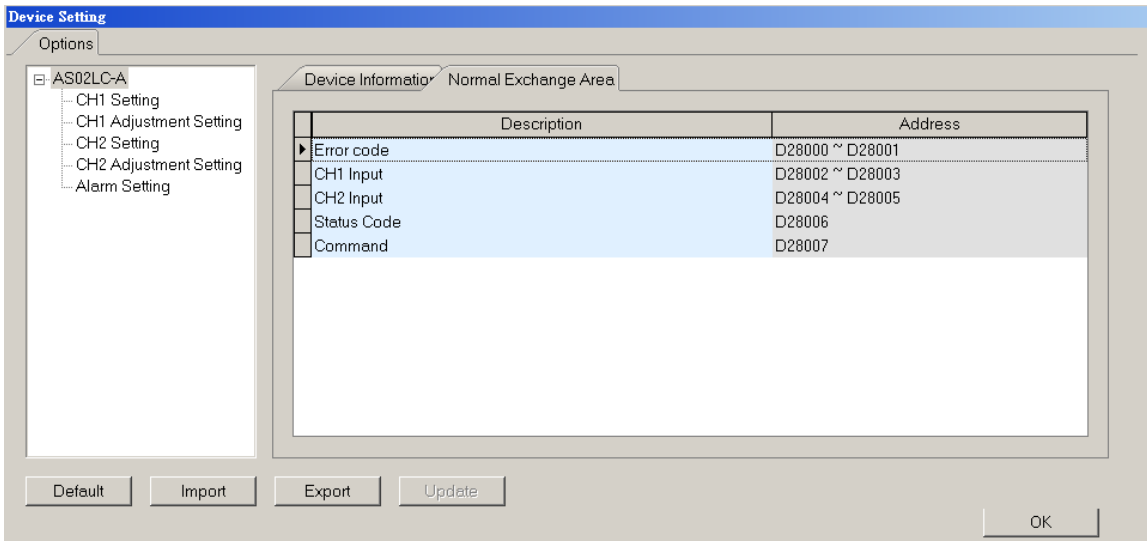

7

Step 5: Write the instruction of activating the weight calibration 98 into D28007.

Step 6: Put no load on the load cell (adjustment point 1) and write 1 into D28007. (1 represents channel 1 and 2 represents channel 2)

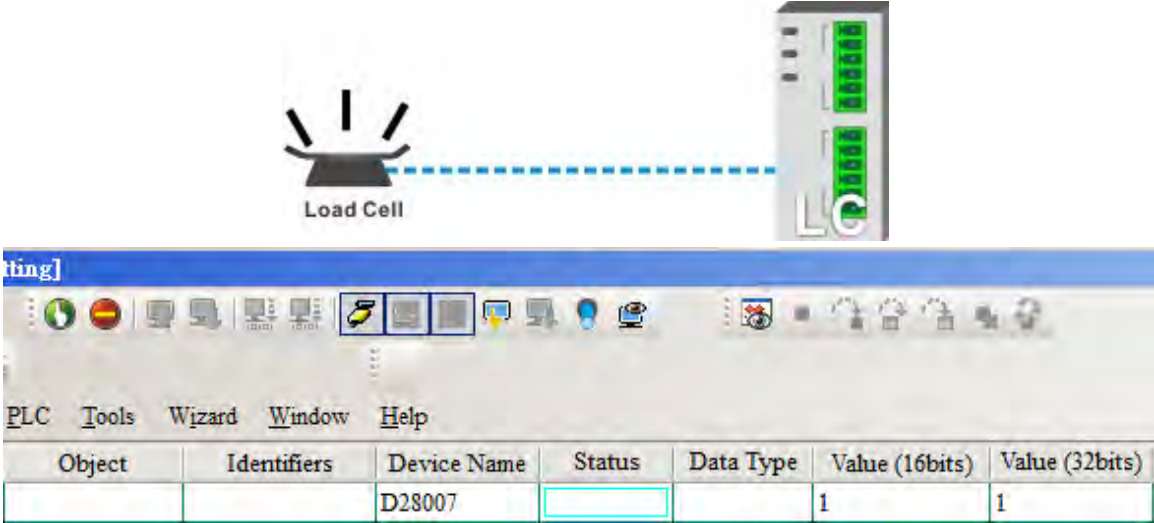

Step 7: Put a load on the load cell (adjustment point 2). For multi-point adjustment, repeat this step. This example uses a 1Kg.

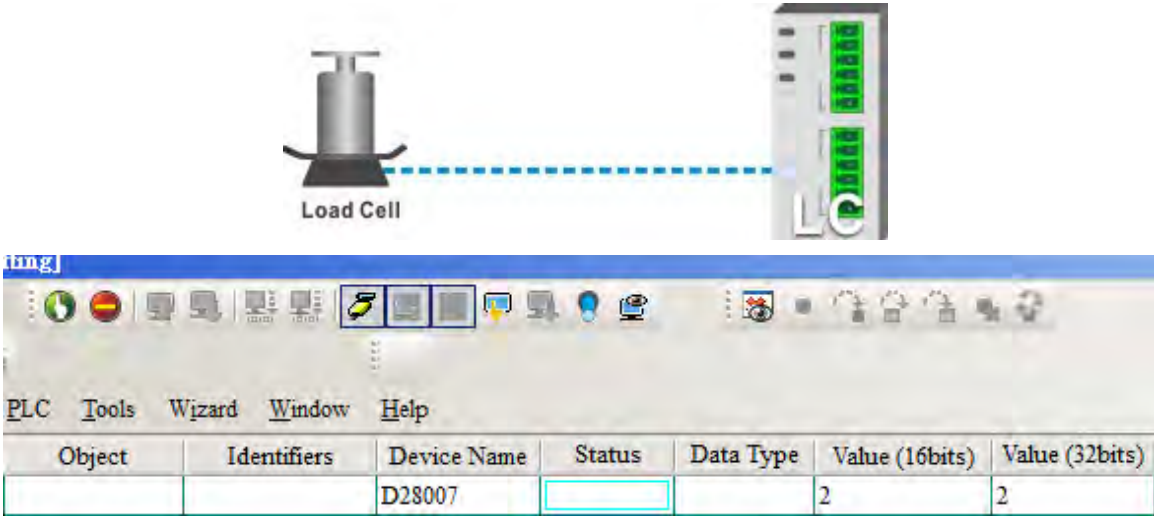

Step 8: Write the instruction of inactivating the weight calibration 99 into D28007 and the adjustment is done.

A characteristic curve is shown below.

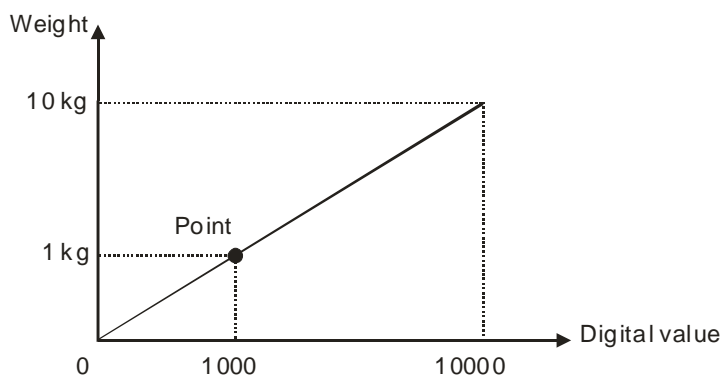

Adjusting two points

7.3.4 LED Indicators

Number	Name	Description
1	RUN LED indicator	Operating status of the module ON: The module is running. OFF: The module stops running.
2	ERROR LED indicator	Error status of the module ON: A serious error occurs in the module. OFF: The module is normal. Blink: A slight error occurs in the module.
3	Digital to analog conversion indicator	Indicating the digital to analog conversion status Blinking: conversion is taking place OFF: stop conversion

7.4 HWCONFIG in ISPSOft

7.4.1 Initial Setting

- (1) Start ISPSOft, and then double-click **HWCONFIG**.

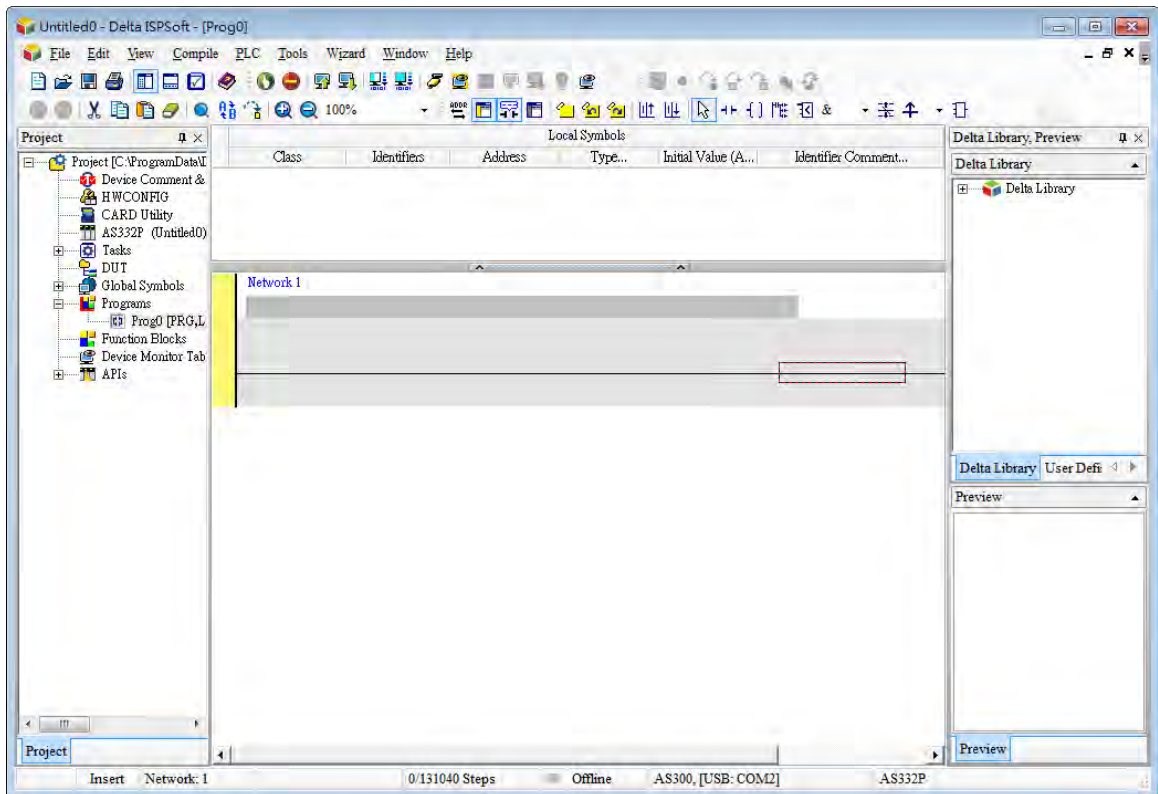

- (2) Selecting a module.

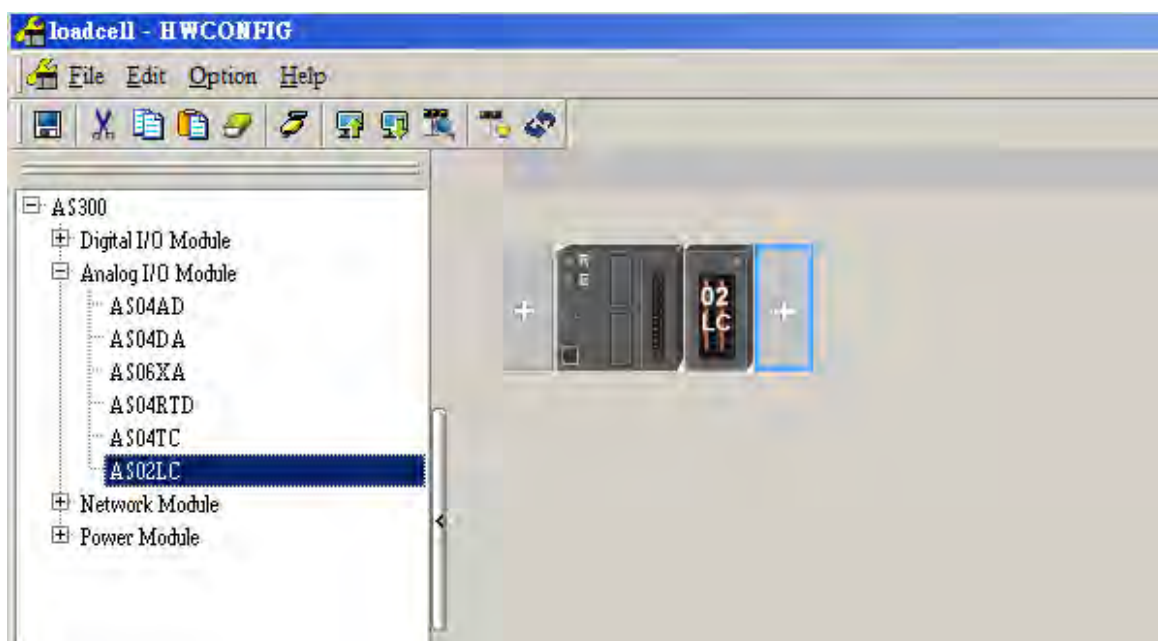

(3) Double-click the module to open the Device Setting page.

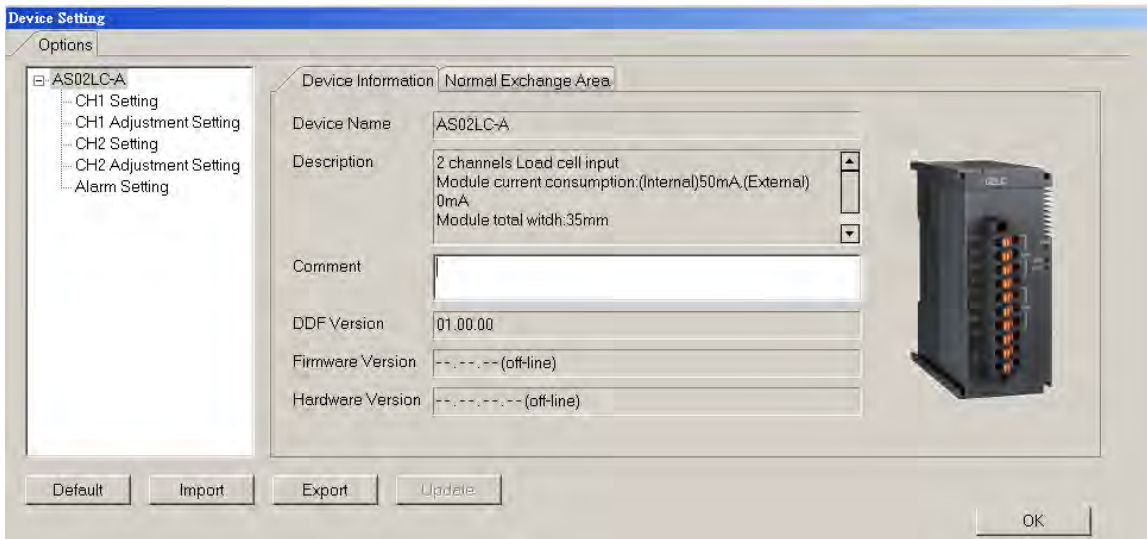

(4) Set the parameters, and then click **OK**.

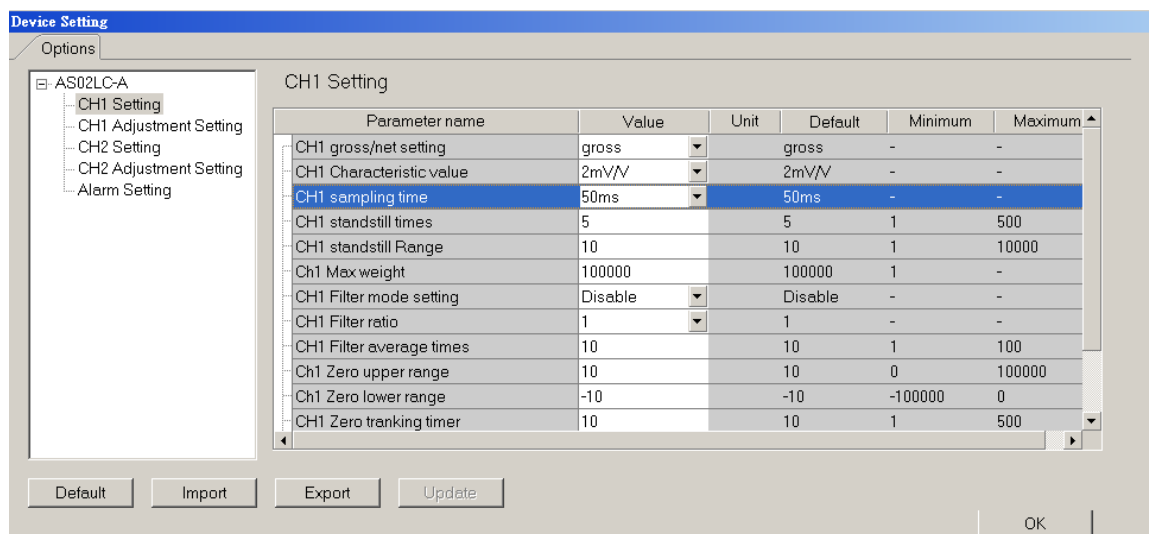

- (5) Click **Download** on the toolbar to download the parameters. (The parameters can not be downloaded when the CPU module runs.)

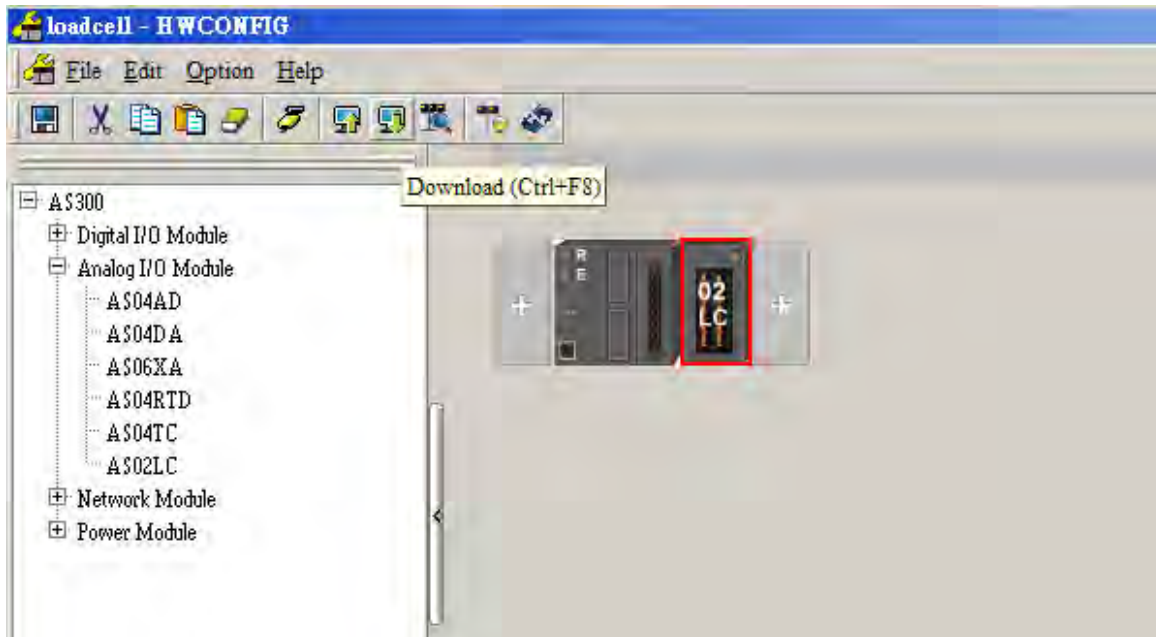

7.4.2 Checking the Version of a Module

- (1) On the **Option** menu, click **Online Mode**.

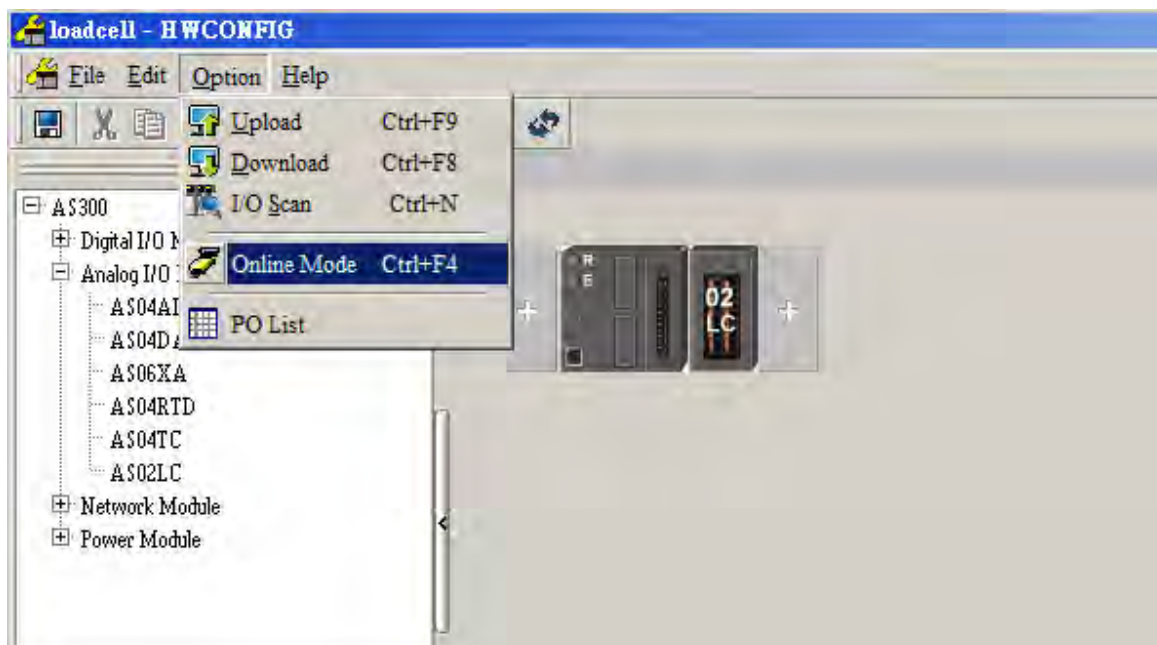

- (2) Double-click the module to see the Device Setting page. The version of the firmware and that of the hardware are displayed.

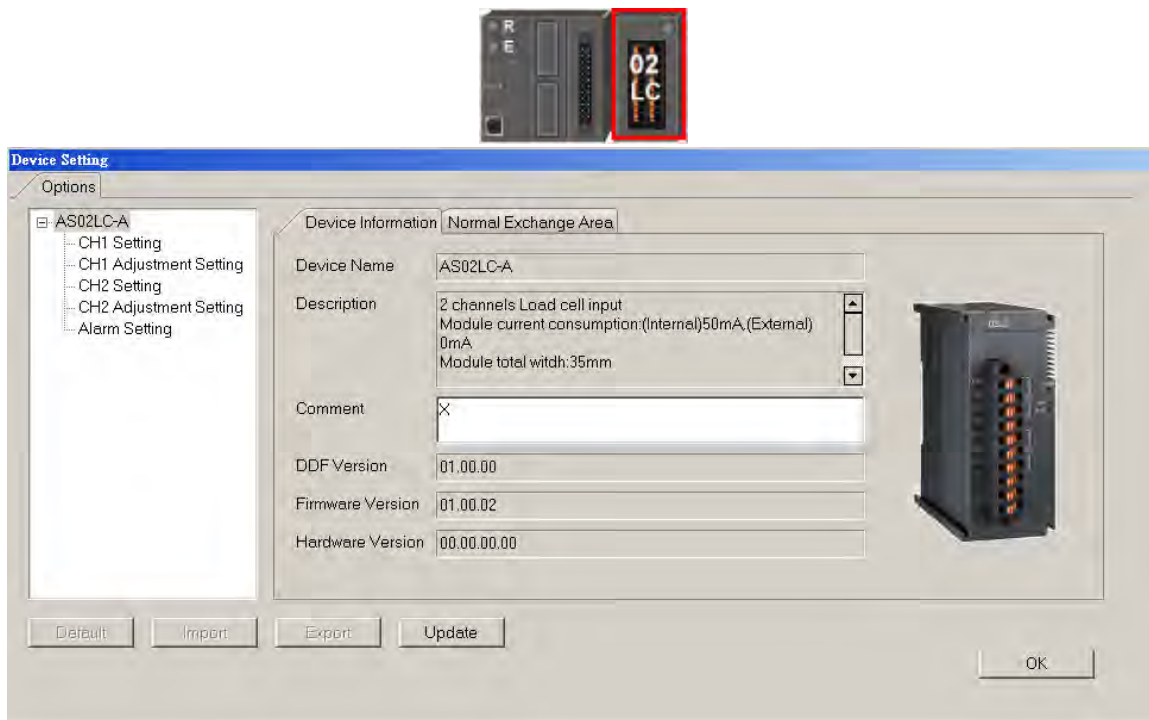

7.4.3 Online Mode

- (1) Click **Online Mode** on the toolbar.

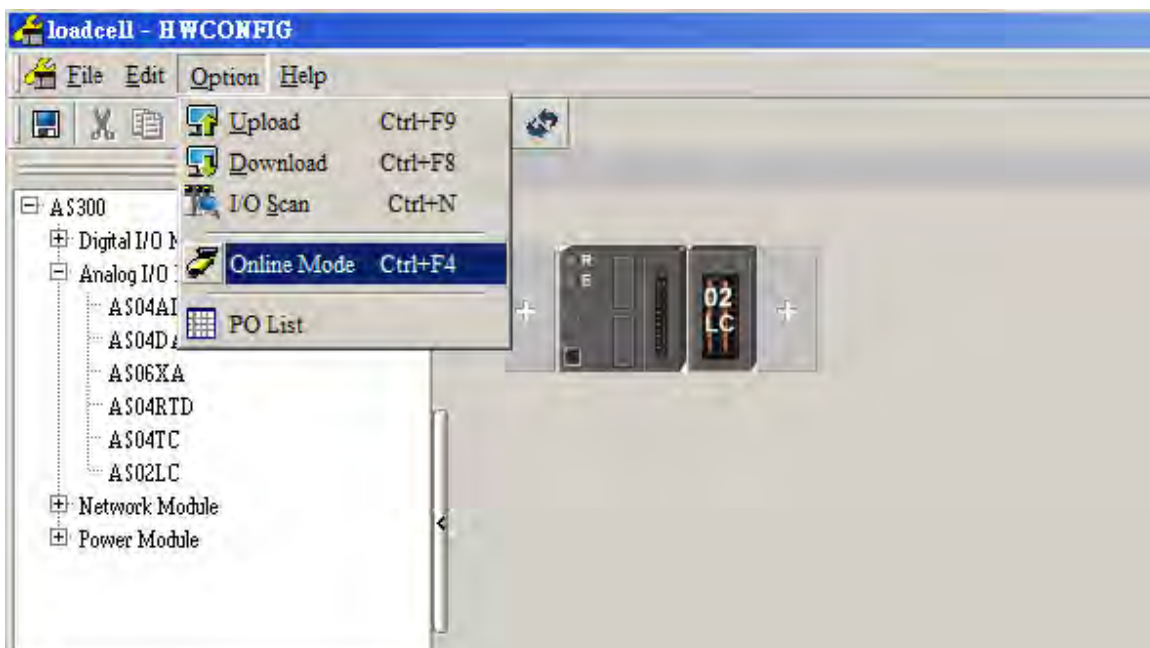

(2) Right-click the module.

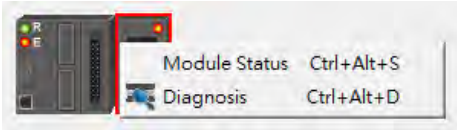

(3) The module status can be shown.

Channel	Value (32 bits)	Data Type
Error code	0	DECIMAL
CH1 Input	1128654438	DECIMAL
CH2 Input	1128746189	DECIMAL
Status Code	49160	DECIMAL
Command	0	DECIMAL

7.4.4 Importing/Exporting a Parameter File

(1) After **Export** is clicked, the parameters will be saved as a CSV file (.csv).

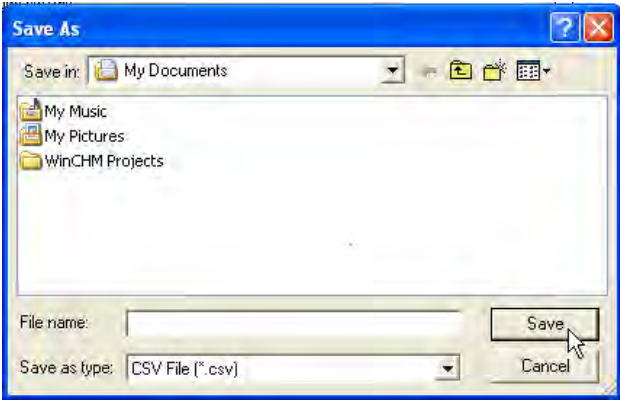



(2) Click **Import**, and then select the CSV file.

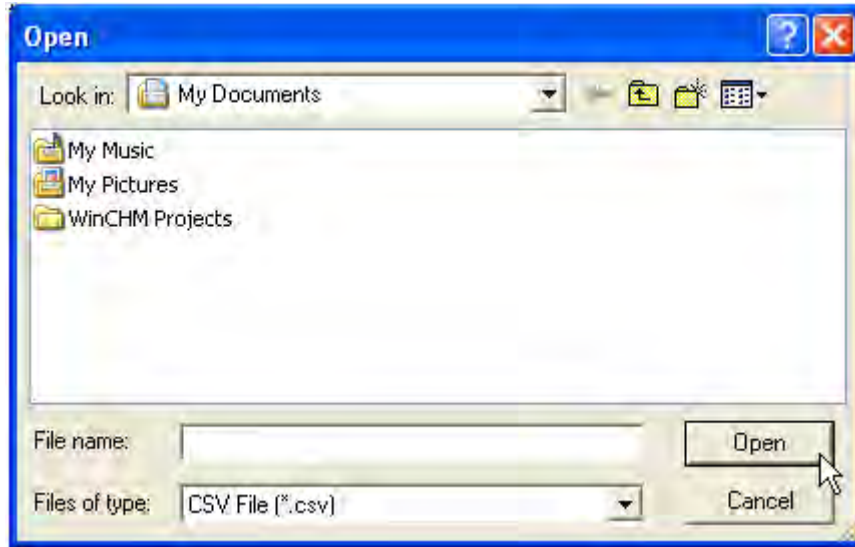
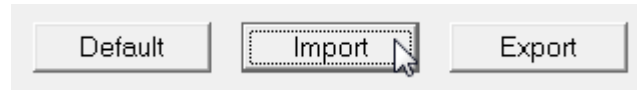

7.4.5 Parameters

(1) The settings for channel 1

Device Setting

Options

- AS02LC-A
 - CH1 Setting**
 - CH1 Adjustment Setting
 - CH2 Setting
 - CH2 Adjustment Setting
 - Alarm Setting

CH1 Setting

Parameter name	Value	Unit	Default	Minimum	Maximum
CH1 gross/net setting	gross		gross	-	-
CH1 Characteristic value	2mV/V		2mV/V	-	-
CH1 sampling time	50ms		50ms	-	-
CH1 standstill times	5		5	1	500
CH1 standstill Range	10		10	1	10000
Ch1 Max weight	100000		100000	1	-
CH1 Filter mode setting	Disable		Disable	-	-
CH1 Filter ratio	1		1	-	-
CH1 Filter average times	10		10	1	100
Ch1 Zero upper range	10		10	0	100000
Ch1 Zero lower range	-10		-10	-100000	0
CH1 Zero tracking timer	10		10	1	500

OK

(2) The adjustment for channel 1

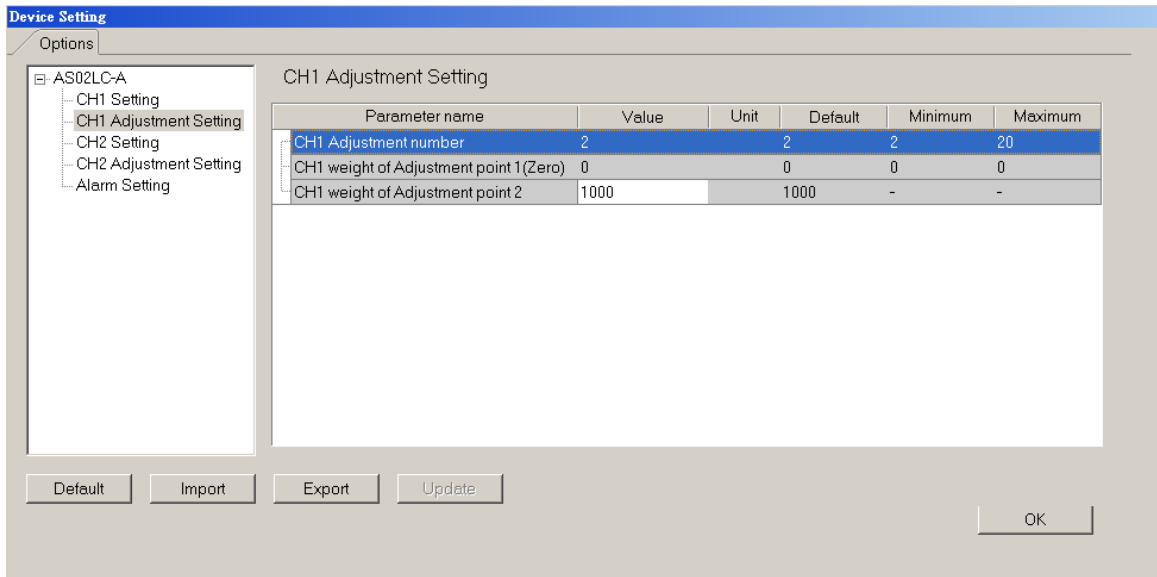

(3) The settings for channel 2

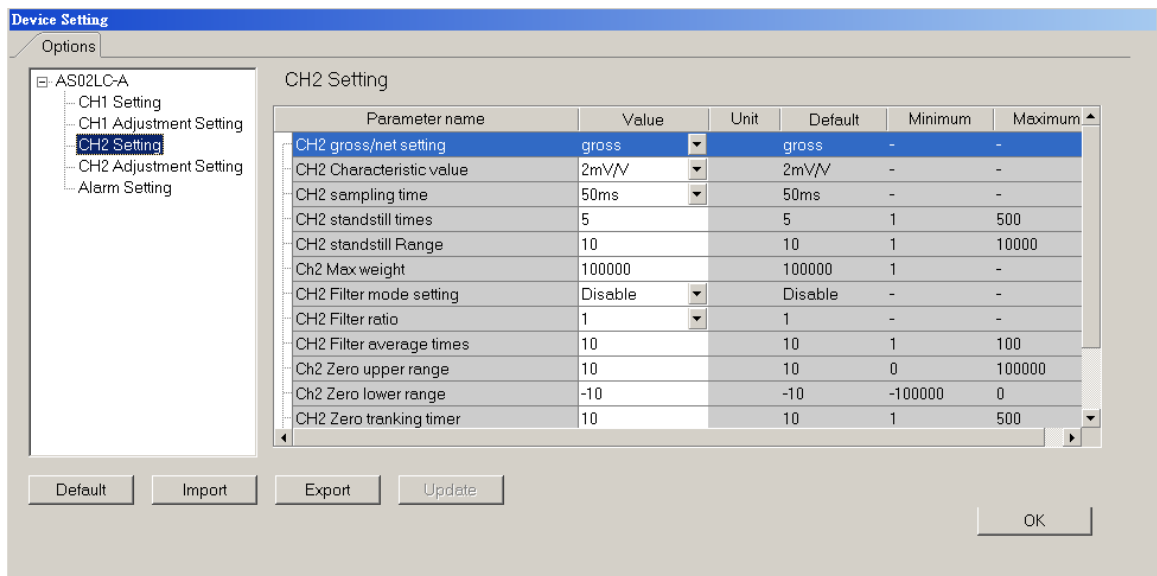

(4) The adjustment for channel 1

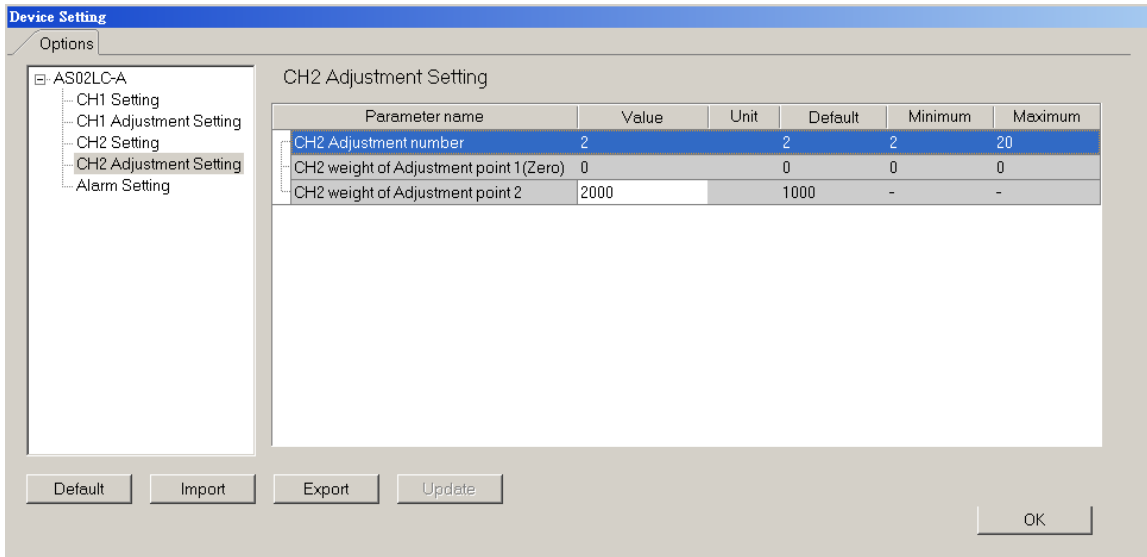

(5) Alarm settings

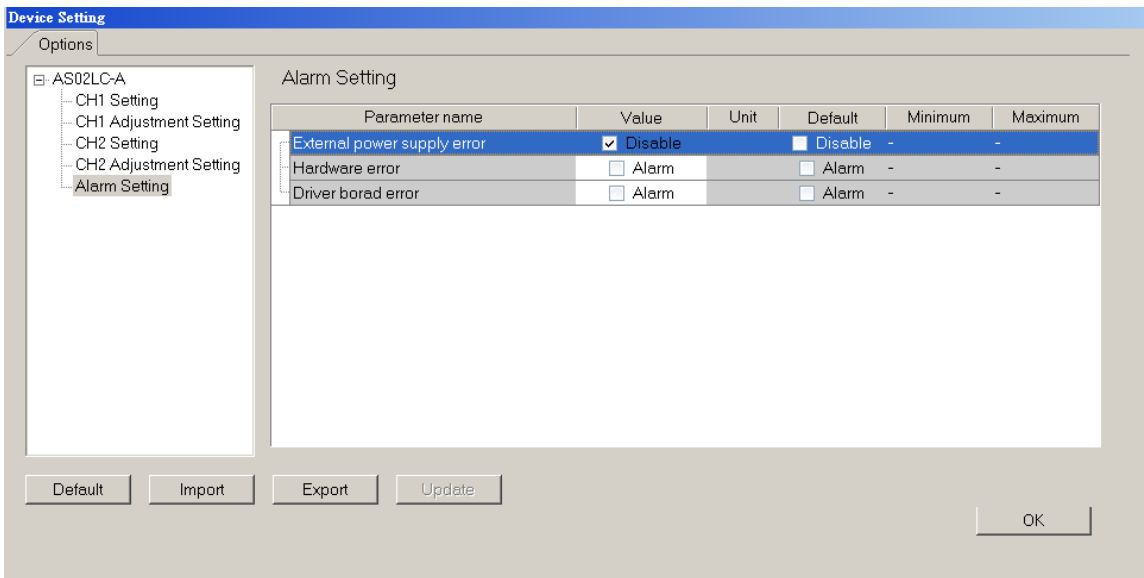

7.5 Troubleshooting

7.5.1 Error Codes

Error Code	Description	A↔ D LED indicator	ERROR LED indicator
16#1605	Hardware failure	OFF	ON
16#1607	The external voltage is abnormal.	OFF	ON
16#1801	The external voltage is abnormal.	OFF	Blinking
16#1802	Hardware failure	OFF	Blinking
16#1807	The driver board is abnormal.	OFF	Blinking
16#1808	The weight measured by CH1 exceeds the maximum weight which can be measured, or the voltage of SEN is incorrect.	Run: blinking Stop: OFF	Blinking
16#1809	The weight measured by CH1 exceeds the maximum weight which can be measured.		
16#180A	CH1 is adjusted incorrectly.		
16#180B	The weight measured by CH2 exceeds the maximum weight which can be measured, or the voltage of SEN is incorrect.		
16#180C	The weight measured by CH2 exceeds the maximum weight which can be measured.		
16#180D	CH2 is adjusted incorrectly.		

7.5.2 Troubleshooting Procedure

Description	Procedure
The external voltage is abnormal.	Check power supply
Hardware failure	Return the module to the factory for repair.
The driver board is abnormal.	Return the module to the factory for repair.
The weight measured by CH1 exceeds the maximum weight which can be measured, or the voltage of SEN is incorrect.	Check the signal received by channel 1 and its wiring.
The weight measured by CH1 exceeds the maximum weight which can be measured.	Check the parameters of the related weight values for channel 1.
CH1 is adjusted incorrectly.	Check the adjusted weight value and the adjustment steps for channel 1.

Description	Procedure
The weight measured by CH2 exceeds the maximum weight which can be measured, or the voltage of SEN is incorrect.	Check the signal received by channel 2 and its wiring.
The weight measured by CH2 exceeds the maximum weight which can be measured.	Check the parameters of the related weight values for channel 2.
CH2 is adjusted incorrectly.	Check the adjusted weight value and the adjustment steps for channel 2.



Chapter 8 Serial Communication Module AS00SCM

Table of Contents

8.1	Introduction	8-2
8.2	Specification, Function and Wiring	8-2
8.2.1	The functional specifications	8-2
8.2.2	Dimensions and Profile	8-3
8.2.3	Wiring	8-4
8.2.3.1	AS00SCM Wiring	8-4
8.3	COM mode	8-6
8.3.1	Modbus	8-6
8.3.2	UD Link	8-6
8.3.2.1	TX Packets and RX Packets	8-6
8.3.2.2	Command	8-9
8.4	RTU Mode	8-10
8.5	Normal Exchange Area	8-12
8.6	Application	8-13
8.6.1	Modbus	8-13
8.6.1.1	Modbus Slave—Connection with Delta Products	8-14
8.6.1.2	Modbus Master—Connection with Delta Products	8-16
8.6.2	UD Link	8-23
8.7	Error Code	8-36
8.7.1	Troubleshooting for Module AS00SCM as a Communication Module.....	8-37
8.7.1.1	ERROR LED Indicator's Being ON.....	8-37
8.7.1.2	ERROR LED Indicator's Blinking Every 0.5 Seconds.....	8-37
8.7.2	Troubleshooting for Module AS00SCM as a Remote Module.....	8-38
8.7.2.1	Error LED Indicator's Being ON.....	8-38
8.7.2.2	ERROR LED Indicator's Blinking Every 0.5 Seconds.....	8-38
8.7.2.3	ERROR LED Indicator's Blinking Every 0.2 Seconds.....	8-39

8.1 Introduction

Thanks for using AS00SCM, a serial communication module. To ensure that AS00SCM is installed and operated correctly, please read this manual carefully before using the module.

AS00SCM is a serial communication module, supporting the communication cards AS-F232, AS-F422, AS-F485 as well as AS-FCOPM (COM2). It supports the protocols such as Modbus and UD Link (user-defined format). AS00SCM is set by means of ISPSOft. Please download ISPSOft V3.0 or later version in Delta's official website. As for UD Link, this is set by means of SCMSOft in DCISOft. Please download DCISOft V1.16 or later version in Delta's official website.

Functions:

- It is equipped with two function card slot, supporting the communication cards AS-F232, AS-F422, AS-F485 as well as AS-FCOPM (COM2).
- It supports serial extension mode and RTU mode (needs to work with AS-FCOPM via COM2).
- The serial extension mode supports Modbus communication protocol (needs to work with the communication cards AS-F232, AS-F422 and AS-F485) and UD Link, a user-defined communication protocol (needs to work with the communication cards AS-F422 and AS-F485)

8.2 Specification, Function and Wiring

8.2.1 The functional specifications

■ RS-485/RS-422 communication interface

Item	Specifications
Connector type	European-style terminal block, spring-clip connector
Transmission speed	300, 600, 1200, 2400, 4800, 9600, 19200, 38400, 57600, 76800 115200 and 230400 bps
Communication format	Stop bit: 1 bit and 2 bits Parity bit: none, an odd parity bit, and an even parity bit Data bit: 7 bits and 8 bits
Communication protocol	Modbus ASCII/RTU UD Link

■ Electrical specifications

Item	Specifications
Supply voltage	24VDC
Electric energy consumption	0.6W
Weight	Approximately 169g

8.2.2 Dimensions and Profile

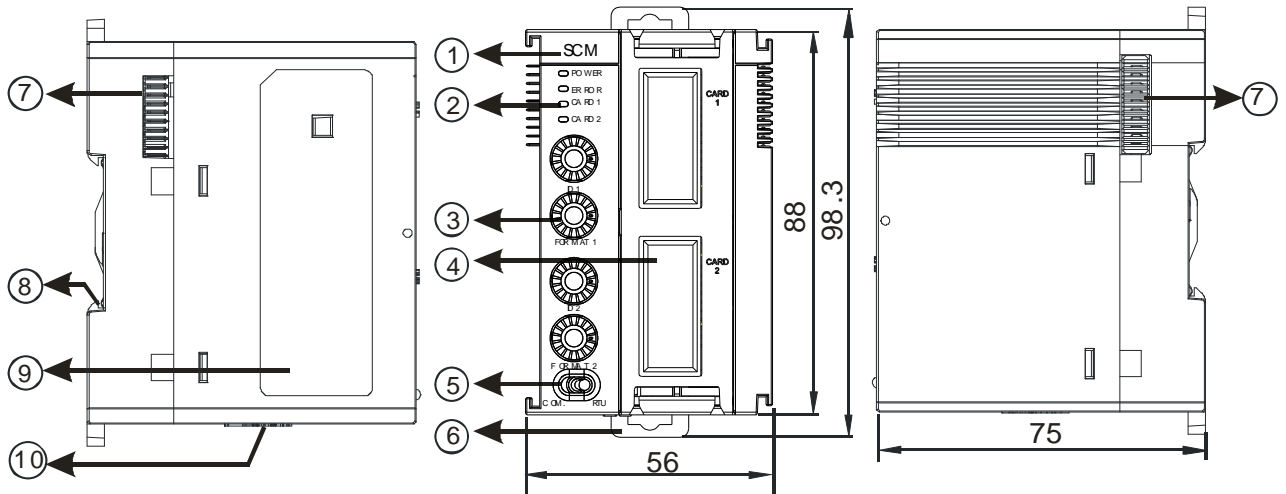

Unit: mm

Number	Name	Description
1	Model name	Model name of the module
2	RUN LED indicator (blue)	Operating status of the module ON: The module is running. OFF: The module is with low voltage or no power
	ERROR LED indicator (red)	Error status of the module ON: There is a hardware error. OFF: The module is normal. Blink: 1. The setting of the module is incorrect, or there is a communication error. (blinking every 1 second) 2. Hardware/low voltage error (blinking every 0.2 second)
	Function Card 1 indicator (orange)	Blink: The data is being transmitted via function card 1. OFF: No transmission via function card 1.
	Function Card 2 indicator (orange)	Blink: The data is being transmitted via function card 2. OFF: No transmission via function card 2.
3	Switch of the communication ID and the format setting	2 sets, one for function card 1 and one for function card 2 respectively
4	Function card 1 slot	For AS-F232, AS-F422, AS-F485
	Function card 2 slot	For AS-F232, AS-F422, AS-F485, AS-FCOPM
5	Switch of work mode setting	COM is for communication mode and RTU is for remote control mode
6	DIN rail clip	Securing the module onto the DIN rail
7	Module connecting set	Connecting the modules
8	Ground clip	
9	Label	Nameplate
10	Power input for RTU module	For supplying power to RTU module

- Communication ID and the format setup switch

When the setting value is 0, this setup is via ISPSOft. The setting range for the communication ID via the switch is 0x01~0x0F.

COM. Mode: If users need to use the communication ID 0x10~0xF7, users need to set the setting here to 0 and then configure this setting via ISPSOft.

RTU Mode: when the module is in RTU mode, the communication ID can only be set via the switch and it cannot be set by means of ISPSOft.

ID Setup			
ID1/ID2	ID Setup	ID1/ID2	ID Setup
0	Via ISPSOft	1-F	Via the switch

- Switch of work mode setting

When the setting value is 0, this setup is via ISPSOft.

COM. Mode: If users need to set differnt communication format, users need to set the setting here to 0 and then configure this setting via ISPSOft.

RTU Mode: when the module is in RTU mode, the communication baud rate can only be set via the switch and it cannot be set by means of ISPSOft.

COM Mode 											
Format 1/ Format 2	Baud rate (bps)	Data (bits)	Parity	Stop (bits)	ASCII/ RTU	Format 1/ Format 2	Baud rate (bps)	Data (bits)	Parity	Stop (bits)	ASCII/ RTU
0	Software setting					8	38400	8	None	2	RTU
1	9600	7	Even	1	ASCII	9	38400	8	None	1	RTU
2	9600	8	Even	1	RTU	A	38400	7	Even	1	ASCII
3	9600	7	None	2	ASCII	B	57600	8	None	1	ASCII
4	9600	8	None	1	RTU	C	76800	8	None	1	RTU
5	19200	7	Even	1	ASCII	D	115200	7	None	1	ASCII
6	19200	8	None	1	RTU	E	115200	8	Even	1	RTU
7	19200	8	Odd	2	RTU	F	115200	7	None	2	ASCII

RTU Mode 								
Format 2	1	2	3	4	5	6	7	8-F
Bit rates (bps)	10K	20K	50K	125K	250K	500K	1000K	NA
Distance (m)	5000	2500	1000	500	250	100	25	NA

8.2.3 Wiring

8.2.3.1 ASO0SCM Wiring

- COM mode:

Switch the work mode to COM. Install the module on the right side of the AS series CPU. Do not use external power supply for this module to avoid problems.

- RTU mode:

Switch the work mode to RTU. This module is equipped with an independent DC power connector.

In order to make the functions of a serial communication module perfect and ensure the reliability of a system at the same time, external wiring which prevents noise is necessary. Before installing cables, users need to follow the precautions below.

- (1) To prevent a surge and induction, a DC cable and other power cables which are connected to AS00SCM-A must be separate cables. AS00SCM is suggested to have an independent power supply.

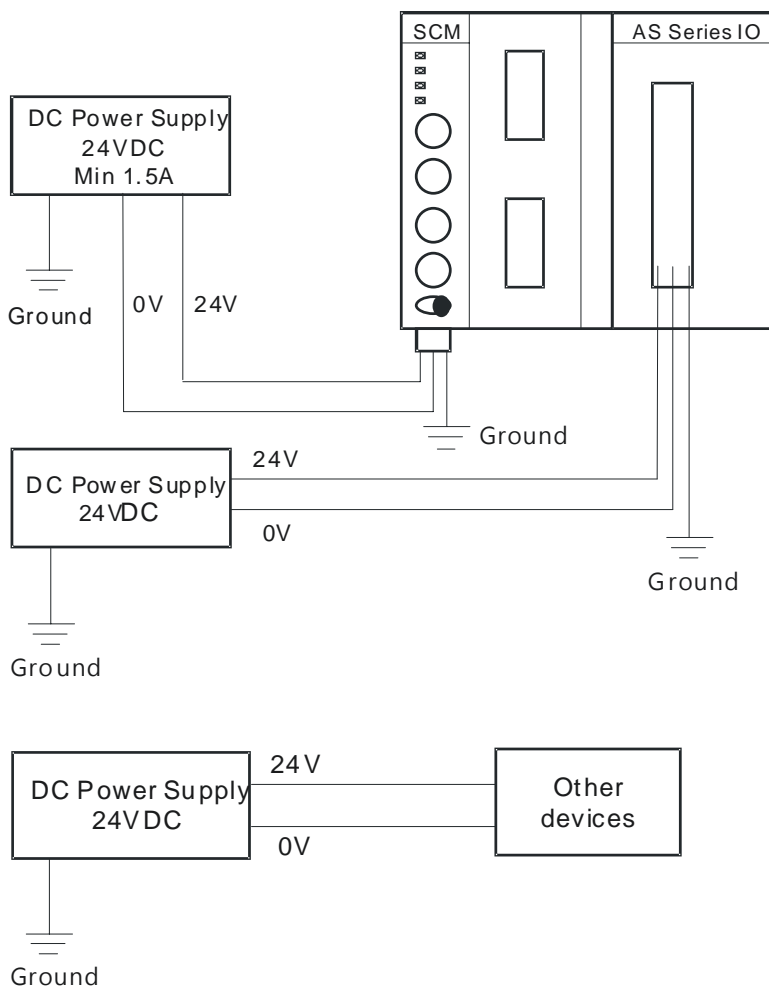

- (2) 24 VDC cable should be twisted. And the shorter end should be connected to the module.
- (3) A cable (110 VAC, 220 VAC and 24 VDC) must not be installed near a main circuit, a high-voltage cable, or a cable connected to a load which is not a PLC. Besides, a cable must not be bound to a main circuit, a high-voltage cable, or a cable connected to a load which is not a PLC. Otherwise, effects that noise, induction, and a surge have will increase. It is suggested to have all the cables should be wired at least 100 mm apart.
- (4) For the power supply of AS00SCM-A, please connect a 14AWG wire to the ground.
- (5) Please connect 20 to 14 AWG (1 mm) wires to the input/output terminals. Only copper leads which can resist the heat above 60/75°C can be used.

8.3 COM mode

This section introduces AS00SCM in the COM mode.

8.3.1 Modbus

AS00SCM supports standard communication protocols such as Modbus RS232, RS422, and RS485. Once the data exchange table is created, users can exchange data with the slaves.

Creation of Modbus communication: set up the communication protocol -> create data exchange table -> download HWCONFIG -> enable this function.

Please refer to section 8.3 data exchange in AS operation manual for more information on the data exchange setup.

8.3.2 UD Link

This section introduces AS00SCM using UD Link communication in COM mode. The setup can be done in SCMSOft. Please refer to section 8.3.2.1 for more details on UD Link and refer to section 8.5 for operation in the software.

The UD Link provides non-Modbus RS485 and RS422 communication. A packet can be edited according to a communication format. The steps of creating an UD Link are as follows.

Creating a group→Editing TX packets and RX packets→Creating commands→Downloading the group, and then triggering the sending/receiving of the packets

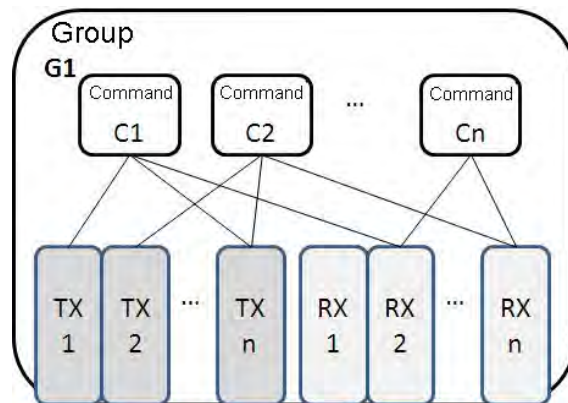

First, create TX packets and RX packets in a group. Then, set the sequence of sending/receiving the packets, and the number of times the packets are sent/received through commands. Finally, the sending/receiving of the packets in the group is triggered. Besides, if several different types of packets are required in a larger system, users can arrange several groups in sequence, and set the sequence of sending/receiving the packets in the groups.

8

8.3.2.1 TX Packets and RX Packets

Several TX packets and RX packets can be created in a group. A TX packet/RX packet is composed of messages, an address, a length, and a checksum.

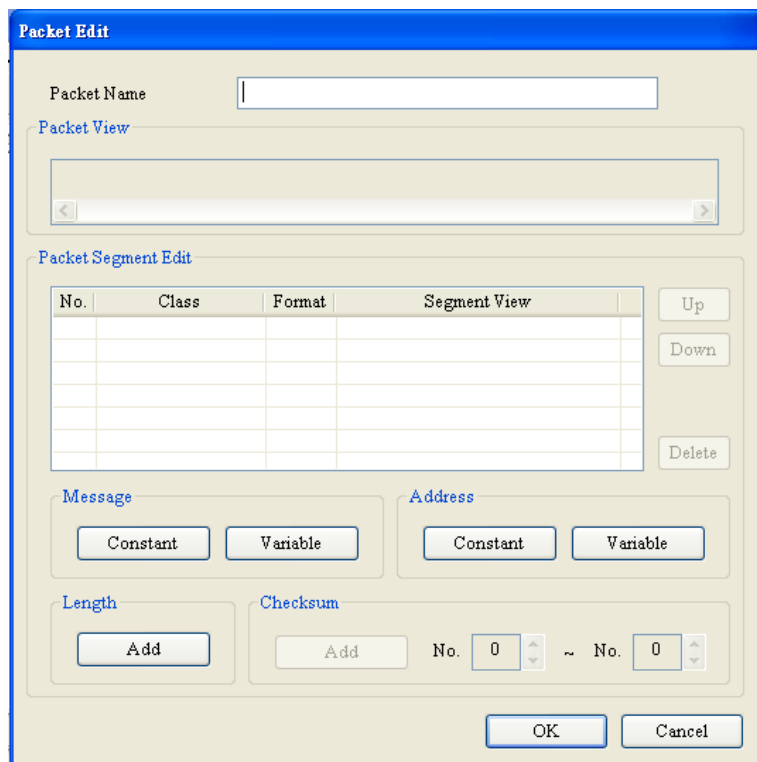

- Packet name: Users can edit a packet name.
- Packet view: The contents of a packet are displayed.
- Packet segment edit: Users can adjust the sequence of segments, and add/delete segments.
 - No.: A segment number is displayed. Users can edit 64 segments at most.
 - Class: A segment class is displayed. A message, an address, a length, and a checksum are classes.
 - Format: The data format of a segment is displayed. A hexadecimal value, an ASCII code, and a code are data formats.
 - Segment view: The contents of a segment are displayed.
- Message: Users can edit “constant” messages and “variable” messages. Messages can be applied to a header segment, a start bit segment, an end bit segment, and a data segment. There can be several messages in a packet.
- Address: Users can edit a “constant” address, and a “variable” address. There is only one address segment in a packet.
- Length: Users can edit the length of a packet. There is only one length segment in a packet.
- Checksum: Users can edit a checksum. There is only one checksum segment in a packet.

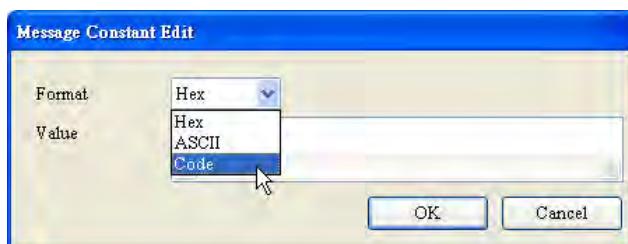

- Constant: Data is a constant.

Format: Users can select **Hex**, **ASCII**, or **Code** in the **Format** box. If **Code** is selected, data used is a control code.

Value: User can enter a constant.

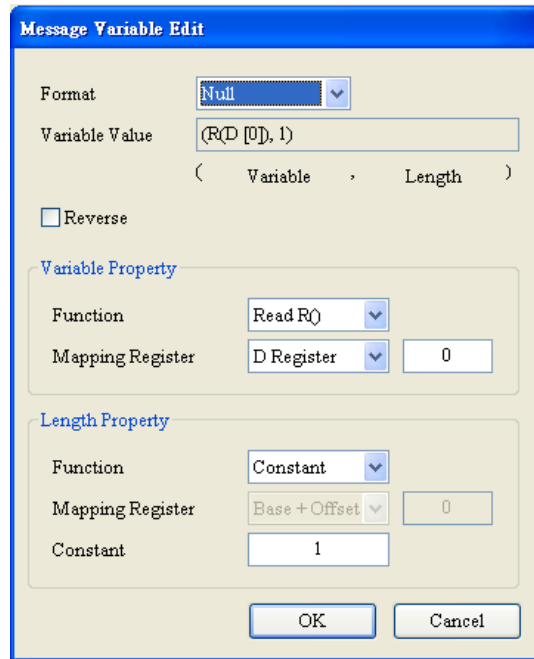

- Variable: Data is a variable. Users can specify an internal register in AH10SCM-5A, or a register in a CPU module.

- Format: Users can set the format of data

Null: Data is not processed.

Hex: ASCII data is converted into hexadecimal data. ASCII data which can not be converted into hexadecimal data will be converted into 0.

ASCII: Hexadecimal data is converted into ASCII data. Hexadecimal data which can not be converted into ASCII data will be converted into 0.

- Variable property

Function: For a TX packet, users can select Read R () in the **Function** box. For a RX packet, the users can select **Read R ()**, **Write W ()**, or * in the **Function** box.

Mapping register: Registers in PLC

- Length

Class: Users can select **1 Byte** or **2 Bytes** in the **Class** box.

Format: Users can select **Hex** or **ASCII** in the **Format** box.

Value: Users can enter a length.

- Checksum

Class: Users can select a class.

Format: Users can select the format of a checksum

Initial value: Users can set an initial value.

Reverse: The high byte of a one-word checksum which is calculated, and the low byte of the checksum are reversed.

8.3.2.2 Command

After several TX packets and RX packets are created, users can select packets which will be sent and packets which will be received by creating commands. Besides, the users can set the sequence of executing the commands.

Command number: Every command is numbered. Command numbers indicate execution sequence.

Command type: Users can select **Send**, **Receive**, or **Send & Receive** in the **Command Type** box.

Send packet: Users can select a packet which has been created.

Receive packet: Users can select a packet which has been created.

Success: Users can specify an action which follows the execution of a command. They can select **Next**, **Goto**, or **End**.

Next: The next command is executed. If the command which is being executed is command 1, the next command which will be executed is command 2.

Goto: Users can specify a command which should be executed much later.

End: Coming to and end

Fail: Users can specify an action which follows the execution of a command. They can select **Next**, **Goto**, or **Abort**.

Next: The next command is executed. If the command which is being executed is command 1, the next command which will be executed is command 2.

Go to: Users can specify a command which should be executed much later.

Abort: Coming to and end

Retry: The sending of a command can be retried after the sending of the command fails. Users can set the number of times the sending of a command is retried.

Repeat: After a command is executed successfully, it can be executed repeatedly. Users can set the number of times the execution of a command is repeated.

Send wait: Users can set an interval between commands. The default is 0 milliseconds, that is, the next command is sent after a reply is received.

Timeout: If no reply is received after a specific period of time, there is communication timeout. The default is 50 milliseconds.

8.4 RTU Mode

- To set up the PLC in the RTU mode, users should set the function card 2 to AS-FCOPM and set up number of the AS remote module: double click AS series PLC->Device setting->function card 2 setting

Parameter name	Value	Unit	Default	Minimum	Maximum
Card 2 Detect mode	Manual		Auto Detect	-	-
Manual Select Card	AS-FCOPM Ca		None	-	-
Card 2 ID No.	1		1	1	254
Protocol Setup Opportunity	Stop → Run		Stop → Run	-	-
Baud Rate	9600	bps	9600	-	-
Data bit	7	bit	7	-	-
Parity bit	Even		Even	-	-
Stop bit	1	bit	1	-	-
MODBUS mode	ASCII		ASCII	-	-
Delay time to Reply	0	ms	0	0	3000
Received Data Timeout	200	ms	200	0	3000
F2AD Analog Input mode	0~10V		0~10V	-	-
F2DA Analog Output mode	0~10V		0~10V	-	-
F2AD Sampling Time	3	ms	3	3	15
F2AD Average Times	10		10	1	15
AS-FCOPM Working mode	AS Remote Co		AS Remote Co	-	-
AS-FCOPM node ID	1		1	1	254
AS Remote module No.	1	unit	1	1	15
Select Run mode after detect remote module	Run connecte		Run connecte	-	-

- To set up the remote module in the RTU mode, users should set the function card 2 to AS-FCOPM (exclusive): double click the remote module ->AS Serial Remote Module->Device setting

Parameter name	Value	Unit	Default	Minimum	Maximum
Function Card Type	AS-FCOPM		AS-FCOPM	-	-
Master Reconnected Handling	IO Module STOP		IO Module STOP	-	-
IO Module Error Handling	IO Module STOP		IO Module STOP	-	-
IO Module timeout Handling	IO Module STOP		IO Module STOP	-	-
Setting delay time to detect IO module	15	0.1sec	15	15	200

1) The procedure of a PLC connection lost:

- I/O module stops: all I/O modules stop running
- I/O module keeps running: all I/O modules keep the same state

- 2) The procedure of an error occurs in I/O module
 - I/O module stops: all I/O modules stop running
 - I/O module keeps running: all I/O modules keep the same state
- 3) The procedure of an I/O connection lost:
 - I/O module stops: all I/O modules stop running
 - I/O module keeps running: all I/O modules keep the same state

Procedure	Settings (RTU)	Digital & analog input modules	Digital output modules	Analog output module (I/O module settings)	
				Clear	Keep
PLC connection lost	I/O module stops running	Cannot update data to the master station	No change on the output value	Output value = 0	No change on the output value
	I/O module keeps the same state			No change on the output value	No change on the output value
An error occurs in I/O module (Ex. Module is broken)	I/O module stops running	Other functional modules: keep updating data to the master station	Other functional modules: Output value = output value of the master station	Output value = 0	No change on the output value
	I/O module keeps the same state			No change on the output value	No change on the output value
I/O connection lost (Ex. Unstable connection)	I/O module stops running			Output value = 0	No change on the output value
	I/O module keeps the same state			No change on the output value	No change on the output value

- Module configuration: please refer to section 8.1.2 in the AS series operation manual.

8.5 Normal Exchange Area

1) COM mode

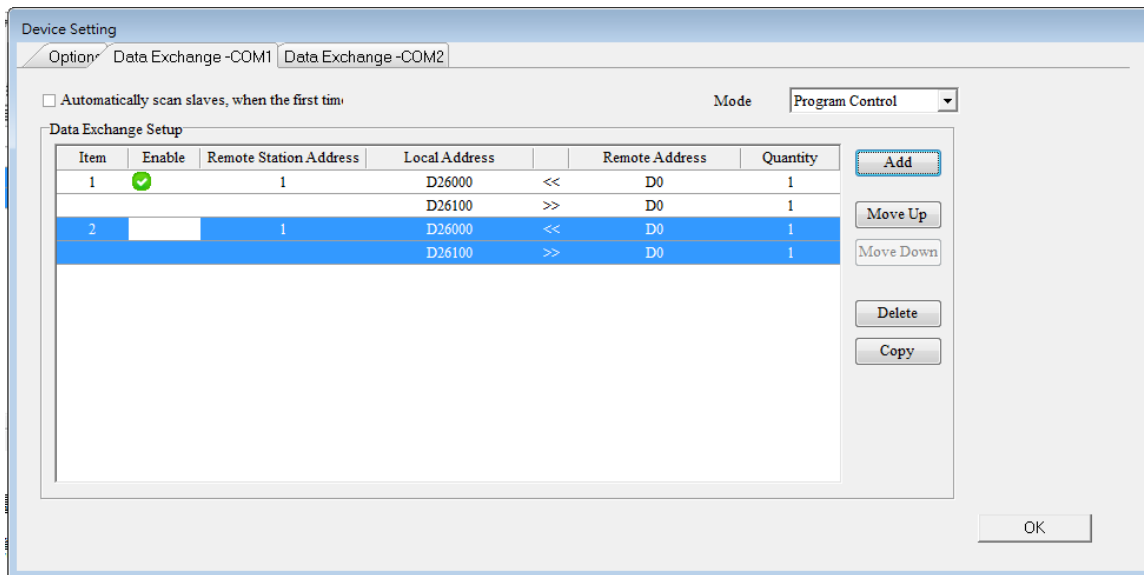
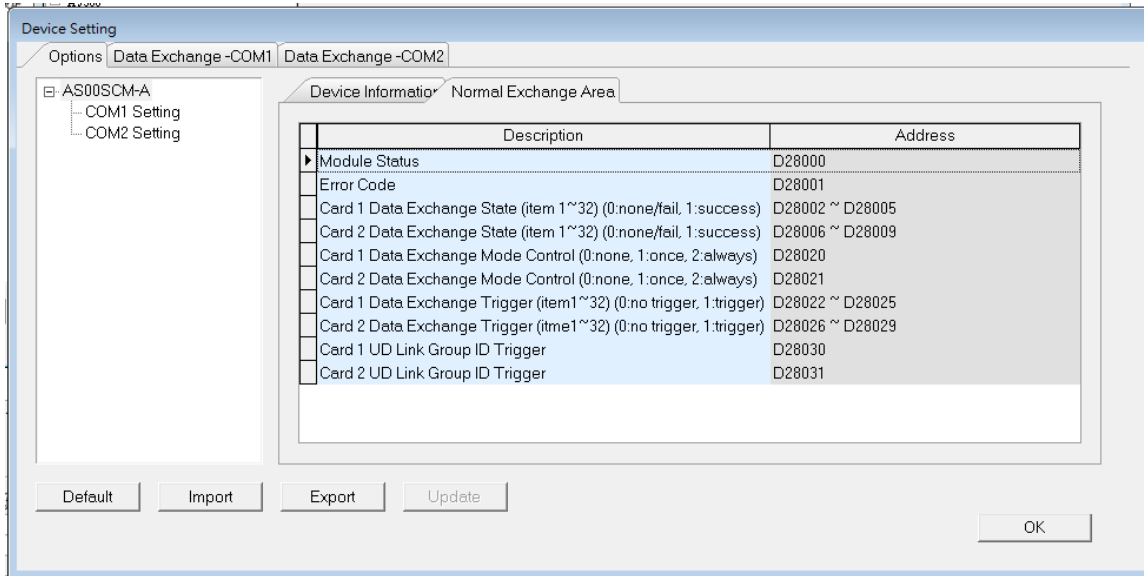

From the above examples, users can see that the corresponding data registers of the module and PLC will be shown automatically in the Normal Exchange area.

- Module Status: 0 = stop, 1 = run
- Error Code: refer to section 8.7 for more information
- Card 1 & Card 2 Exchange State: it occupies 4 data registers (32-bit data); 1~32-bit represent the states of the items 1~32 to be exchanged: 0 = none/fail, 1 = success.
- Card 1 & Card 2 Exchange Mode Control: the data register can be set as 0: none, 1: once, 2: always.
- Card 1 & Card 2 Exchange Trigger: it occupies 4 data registers; 1~32-bit represent the states of the items 1~32 to be exchanged: 0 = no trigger, 1 = trigger.
- Card 1 & Card 2 UD Link Group ID Trigger: input the group ID to be triggered

2) RTU Mode:

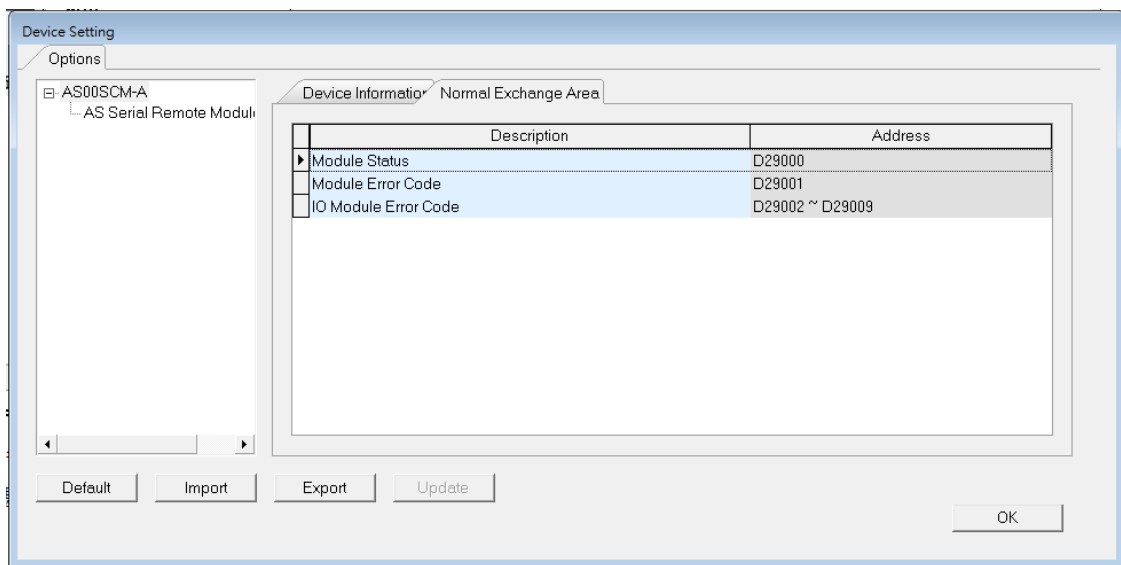

- Module Status: 0 = stop, 1 = run
- Module Error Code: refer to section 8.7 for more information
- I/O Module Error Code: refer to I/O module manual for more information.

8.6 Application

8.6.1 Modbus

This section introduces the how AS00SCM is connected to other Delta industrial products such as a human-machine interface, a temperature controller, a programmable logic controllers, an AC motor drive, and a servo motor through Modbus.

The structure:

Example of a slave structure: HMI (master station) -> AS-F485 + AS00SCM COM1 (slave station)

Example of a master structure: AS-F485 + AS00SCM COM2 (master station) -> VFD, ASDA, and DVP series PLC

Product	Slave ID	Communication protocol	Device from which data is read	Register in the CPU module	Device into which data is written	Register in the CPU module
HMI	5	9600, RTU, 8, E, 1	16#0100	D26100	16#0000	D26000
VFD	10	38400, ASCII, 7, E, 1	16#2103	D26200	16#2000 16#2001	D26300~ D26301
ASDA	11	38400, ASCII, 7, E, 1	16#0101 16#020A	D200, D201	16#0101 16#020A	D250, D251
PLC	12	38400, ASCII, 7, E, 1	D100~D109	D300~D309	D200~D204	D350~D354

8.6.1.1 Modbus Slave—Connection with Delta Products

The slave station supports the following function code and the corresponding addresses:

Function code	Attribute	Addresses supported
0x03 0x04	Read	16#0000~16#0063 16#0100~16#0163 16#0200~16#0263 16#0300~16#0363
0x06 0x10	Write	16#0000~16#0063 16#0200~16#0263
0x17	Read	16#0000~16#0063 16#0100~16#0163 16#0200~16#0263 16#0300~16#0363
	Write	16#0000~16#0063 16#0200~16#0263

If AS00SCM functions as a Modbus slave, users only need to set a slave ID and a transmission speed.

- 1) Drag AS00SCM to the system configuration area.

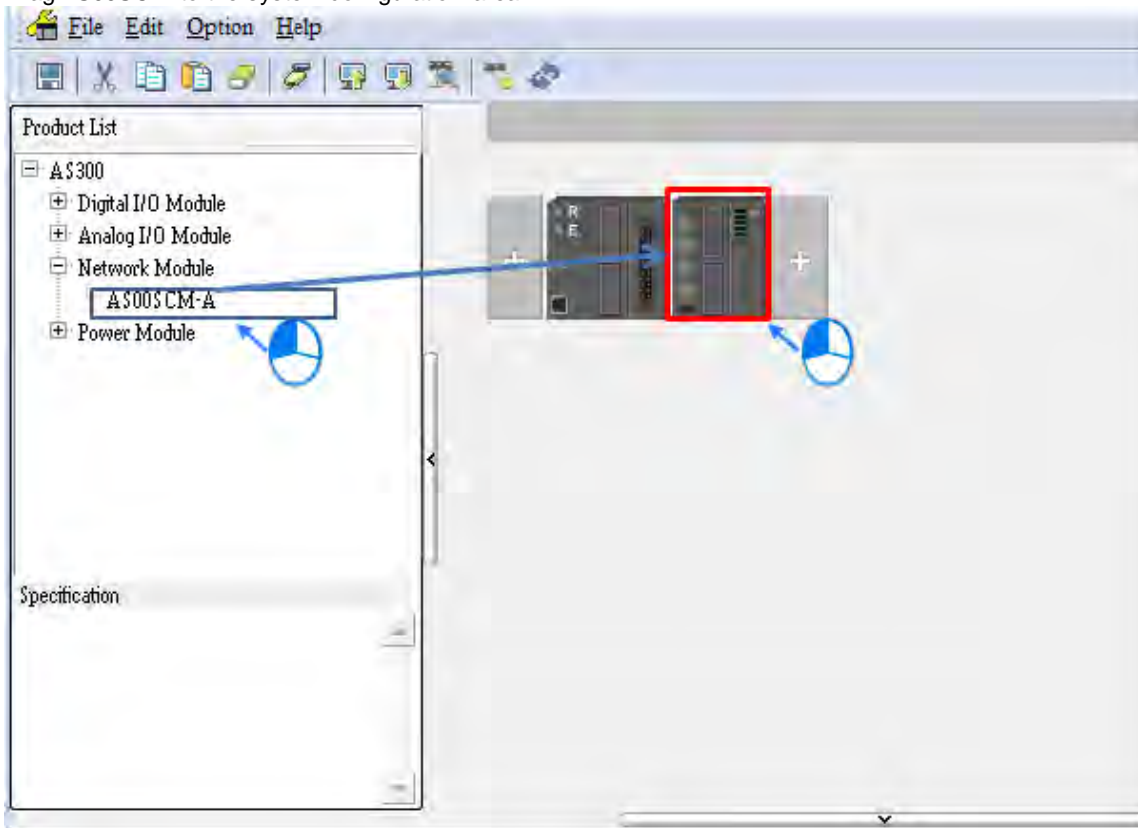

- 2) Click I/O Scan and the system will scan module current configurations. The PLC will assign input and output device range.

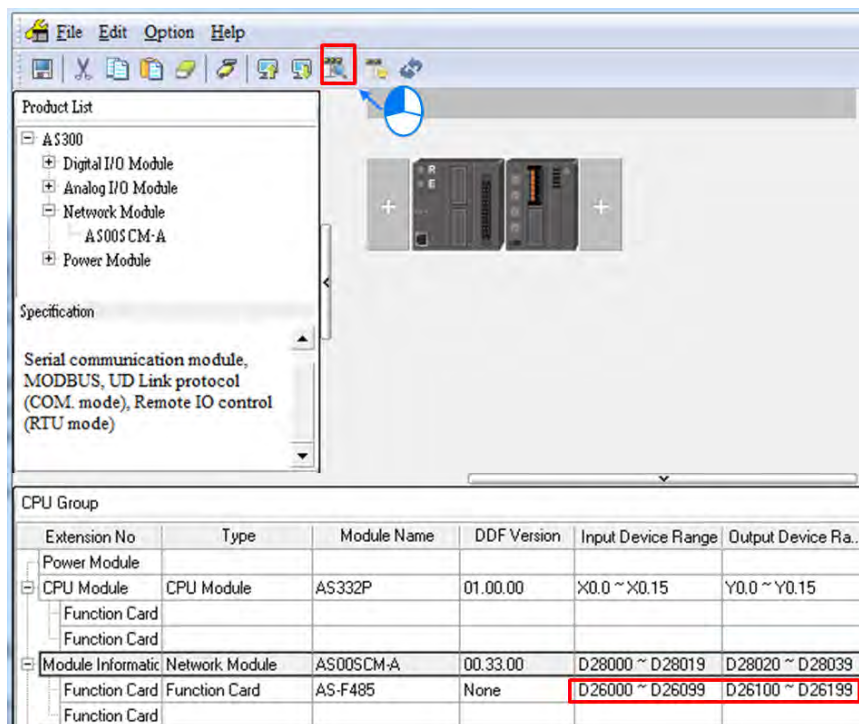

Function card	Device from which data is read	Register in the CPU module	Device into which data is written	Register in the CPU module
Function card 1	16#0000	D26000	16#0100	D26100
Function card 2	16#0200	D26200	16#0300	D26300

- 3) Double-click the SCM module to open the device setting for configurations.

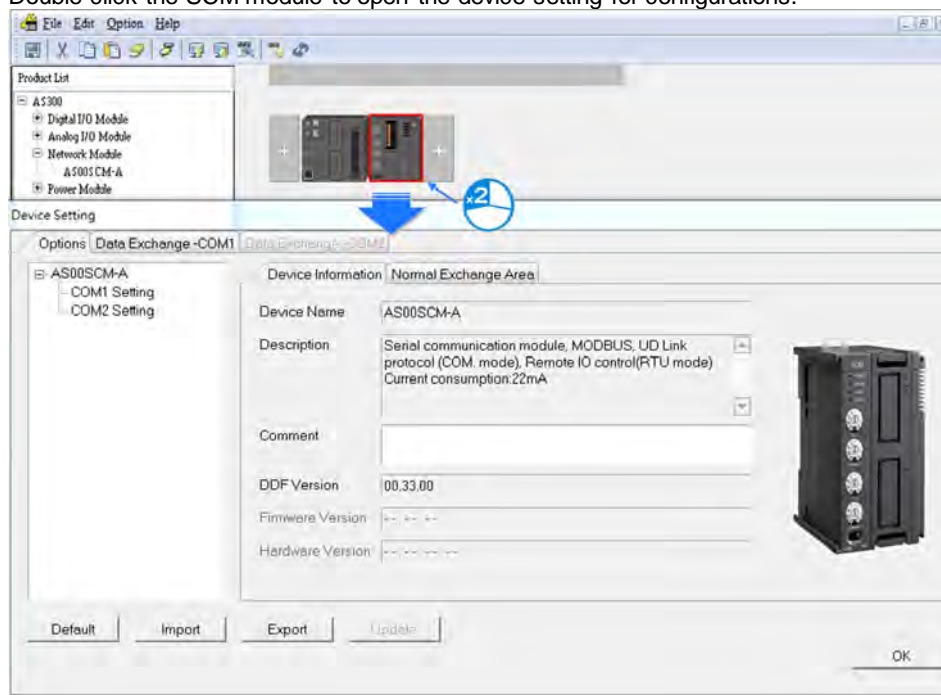

4) Set up the protocol for COM1 to be the same as the format of HMI in the Options page.

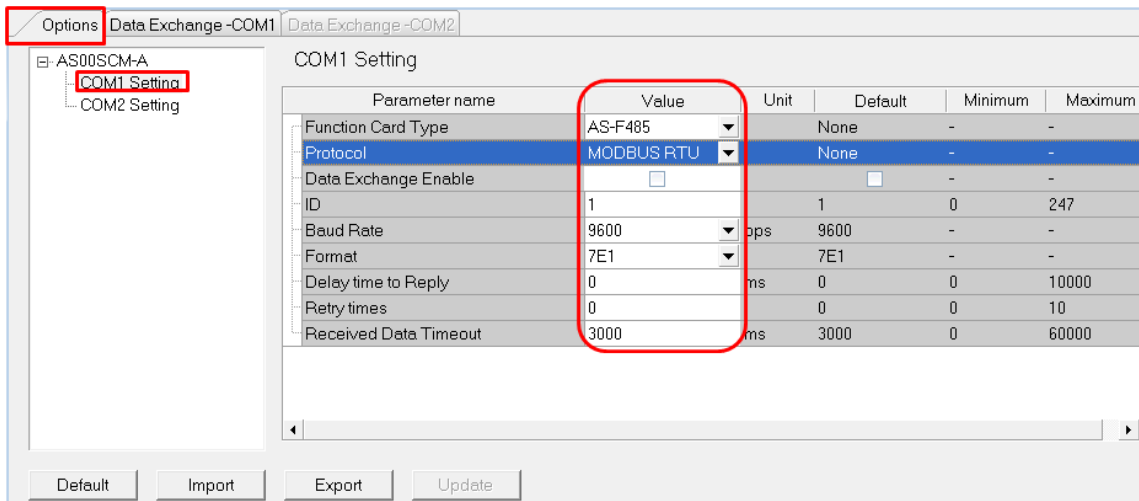

Product	Slave ID	Communication protocol	Device from which data is read	Register in the CPU module	Device into which data is written	Register in the CPU module
HMI	5	9600, RTU, 8, E, 1	0x0100	D26100	0x0000	D26000

5) Download the parameters to AS00SCM.

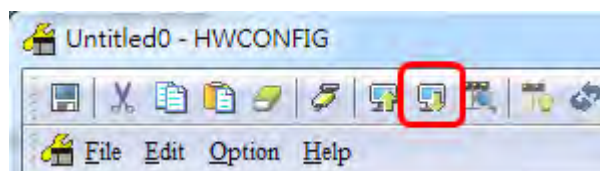

NOTE: Users can double-click the module to open the device setting page to configure the parameters.

8.6.1.2 Modbus Master—Connection with Delta Products

This section introduces the how AS00SCM is connected to other Delta industrial products such as a programmable logic controllers, an AC motor drive, and a servo motor via COM2.

Product	Slave ID	Communication protocol	Device from which data is read	Register in the CPU module	Device into which data is written	Register in the CPU module
VFD	10	38400, ASCII, 7, E, 1	16#2103	D26200	16#2000 16#2001	D26300~ D26301
ASDA	11	38400, ASCII, 7, E, 1	16#0101	D26210	16#0101	D26310
PLC	12	38400, ASCII, 7, E, 1	D100~D109	D26220~ D26229	D200~D204	D26320~ D26324

If AS00SCM functions as a Modbus master, users only need to set a master ID and a transmission speed.

- 1) Drag AS00SCM to the system configuration area.

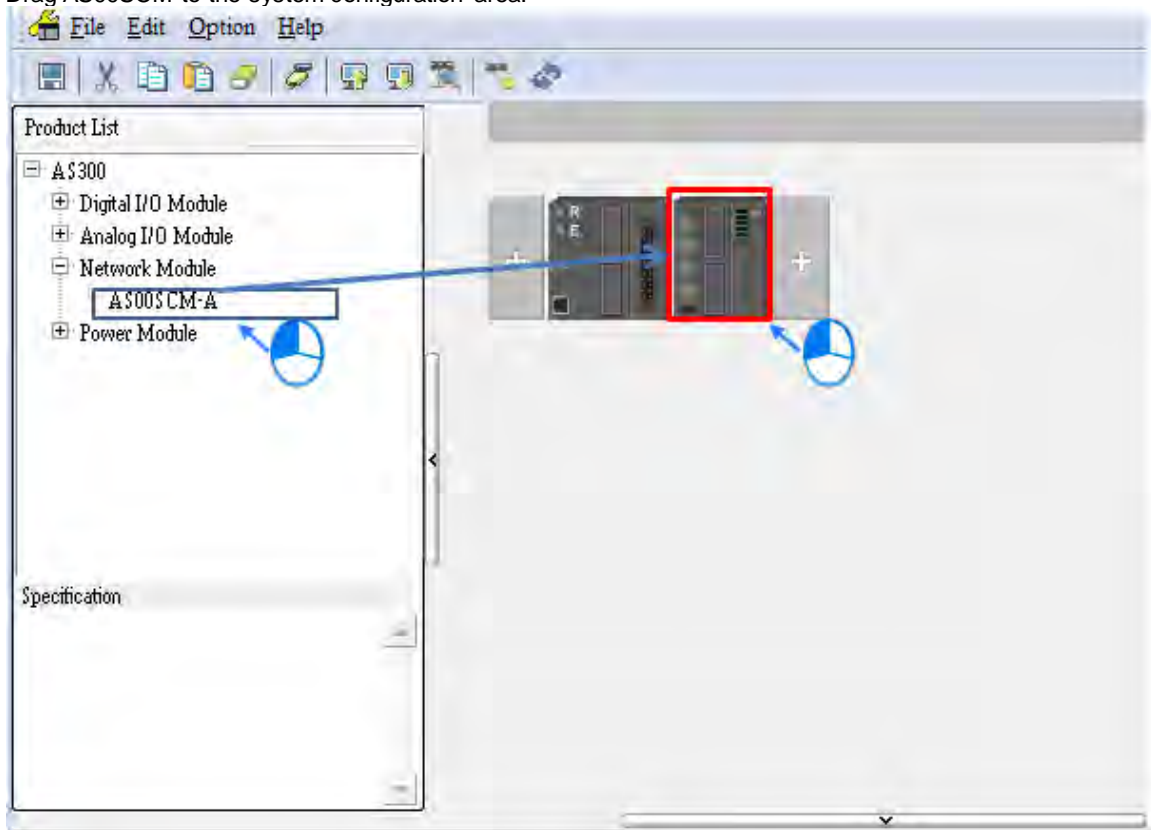

- 2) Double-click the COM2 Setting and select the card as AS-F485.

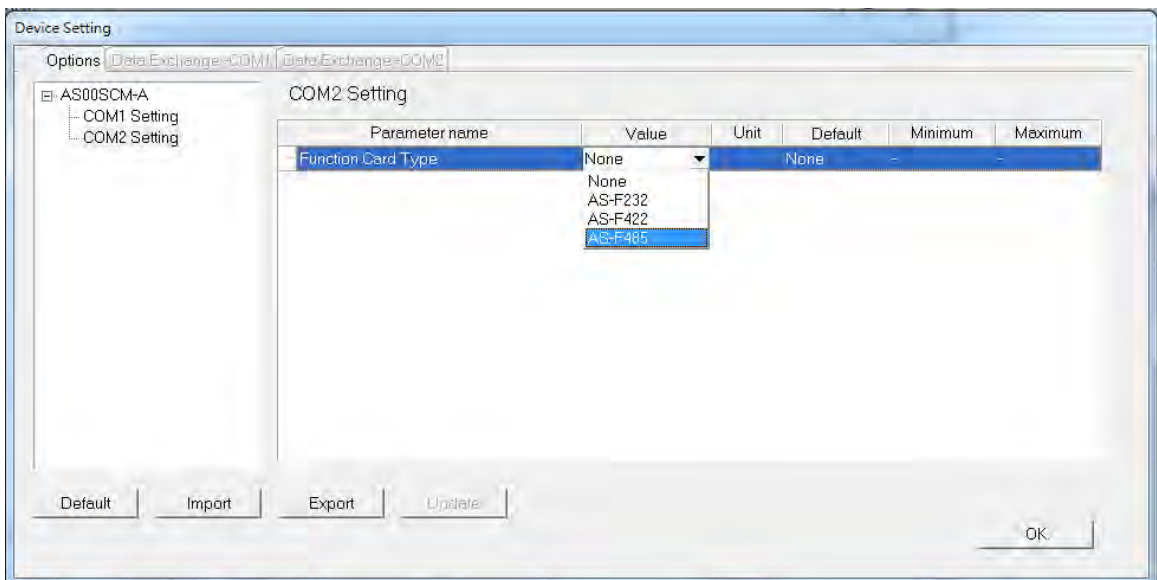

- Click I/O Scan and the system will scan module current configurations. The PLC will assign input and output device range.

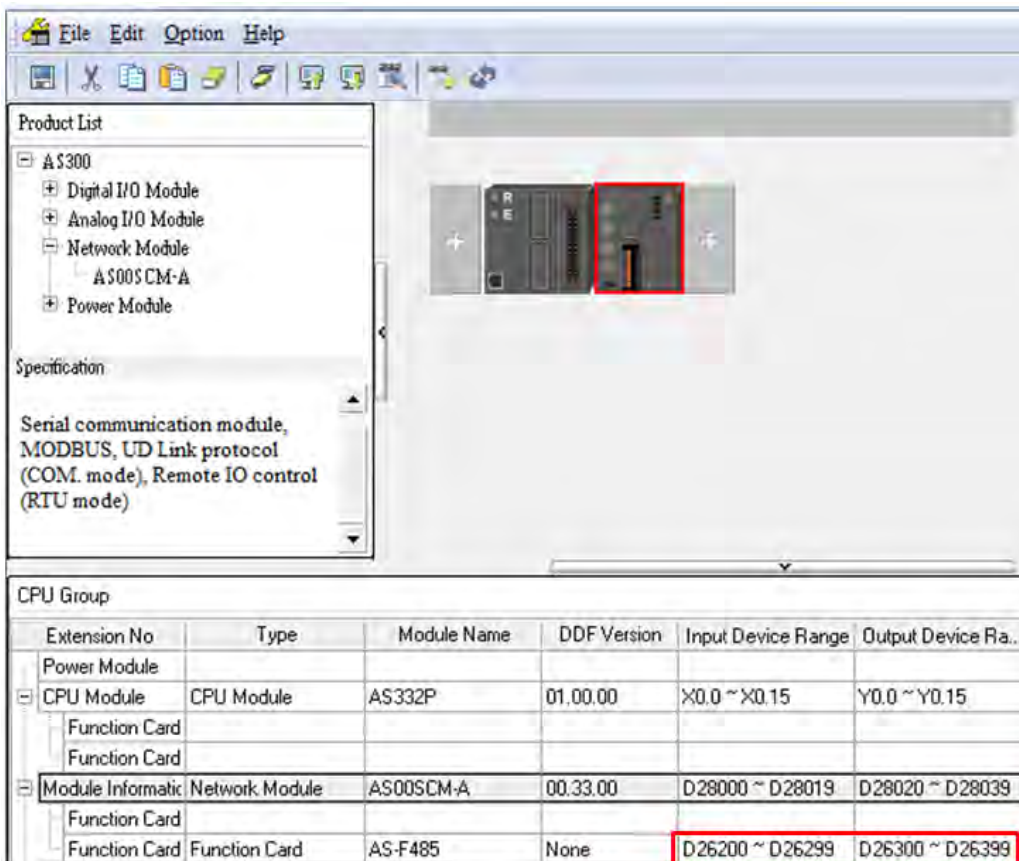

- Double-click the SCM module to open the device setting for configurations.

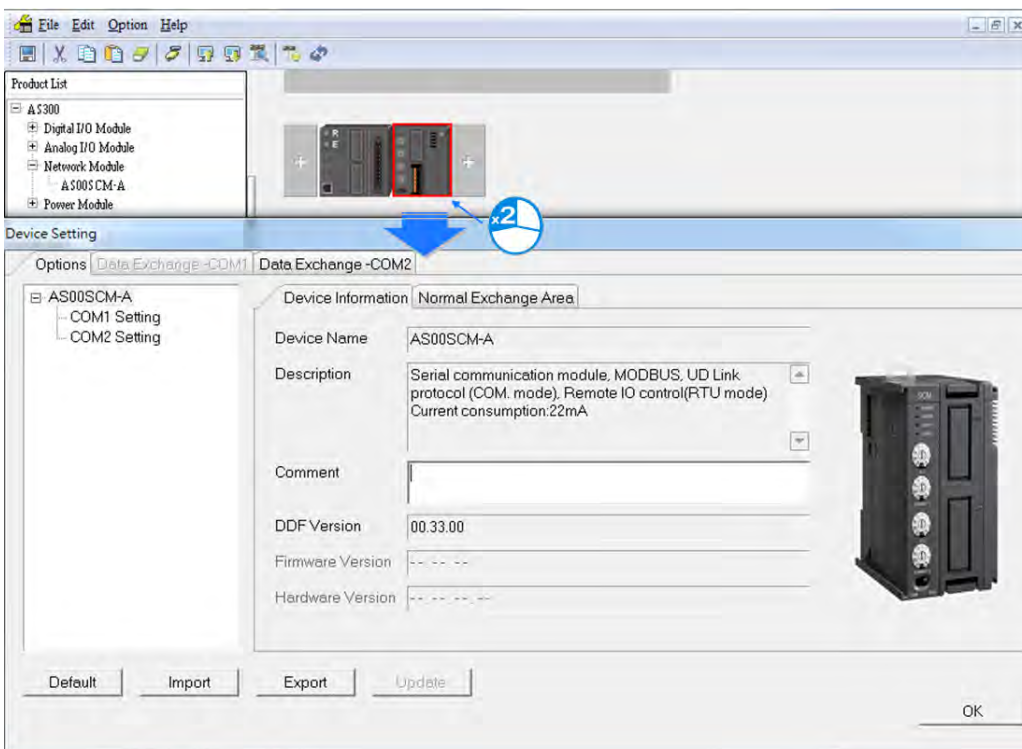

5) Set up the protocol for COM2:

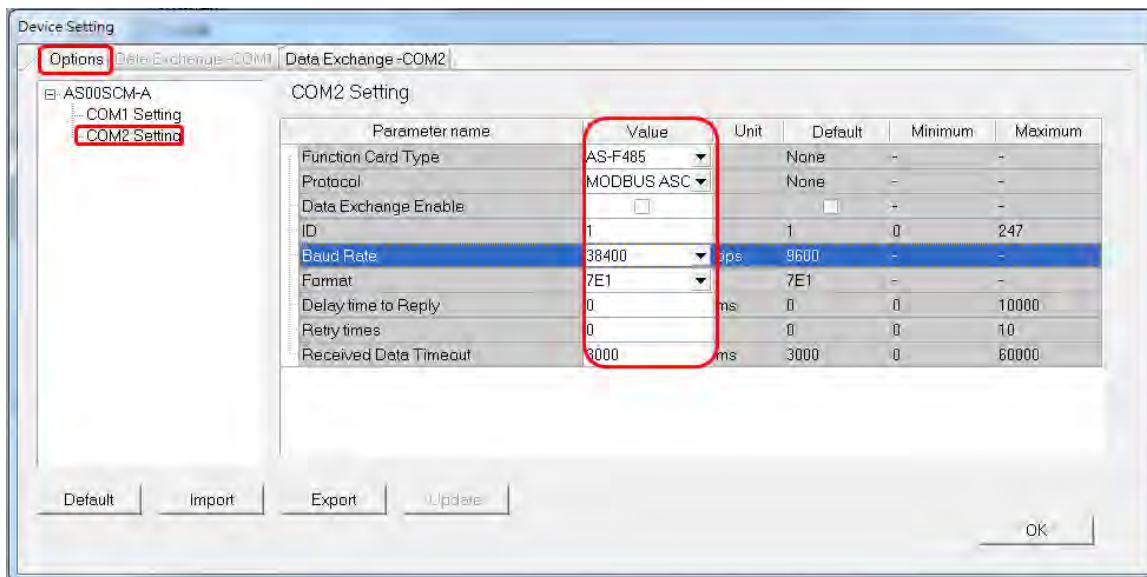

6) Set up the data exchange table: select Data Exchange – COM2 and click Add to create a new data exchange table.

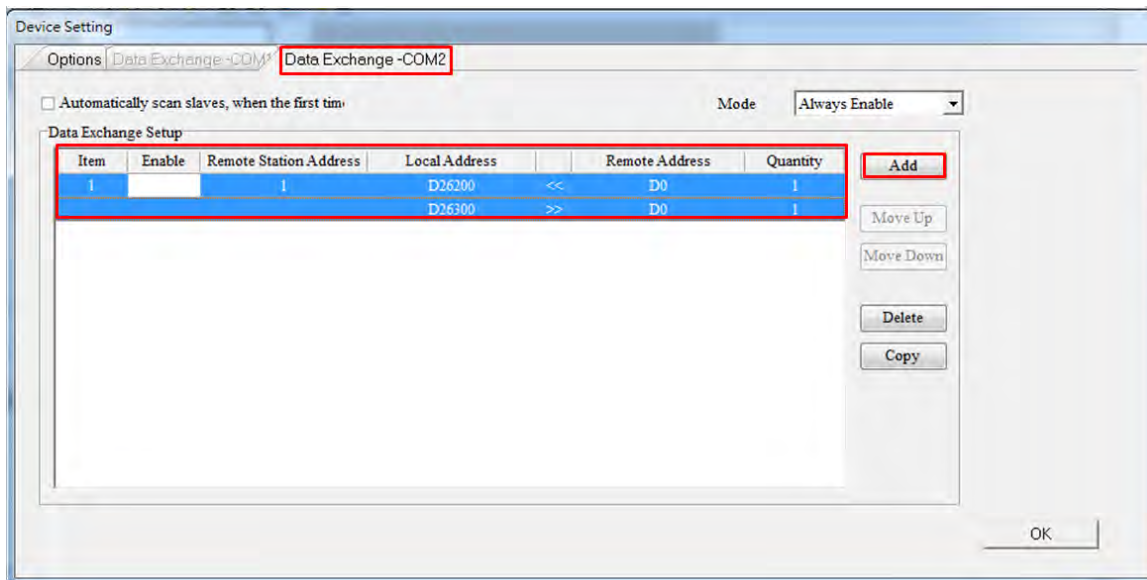

7) Settings in the data exchange: double-click the item to open the editing page.

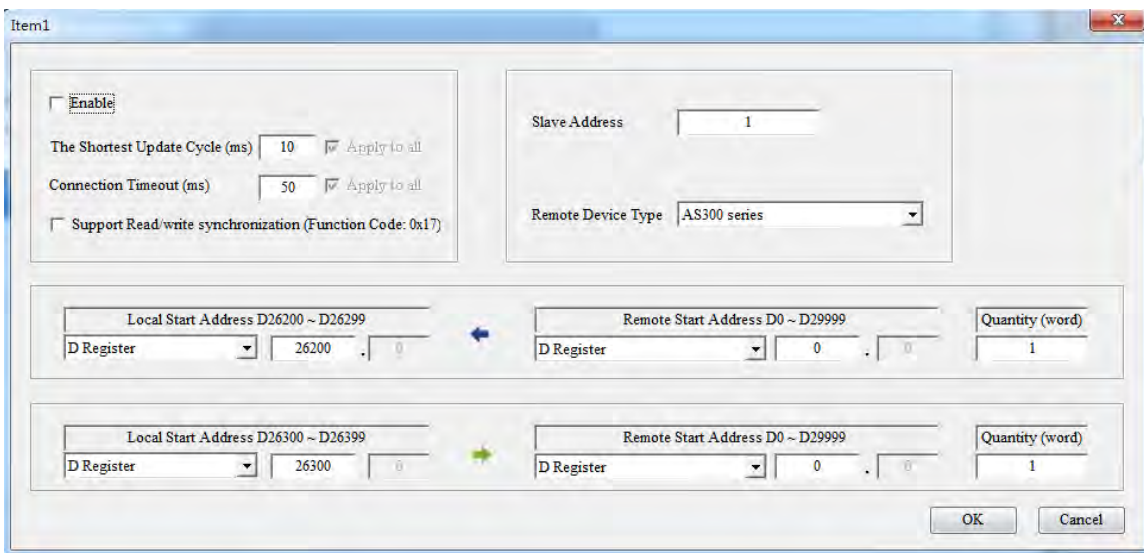

- Select Standard Modbus Device in the Remote Device Type and input the parameters and then select Enable.

Product	Slave ID	Communication protocol	Device from which data is read	Register in the CPU module	Device into which data is written	Register in the CPU module
VFD	10	38400, ASCII, 7, E, 1	16#2103	D26200	16#2000 16#2001	D26300~ D26301

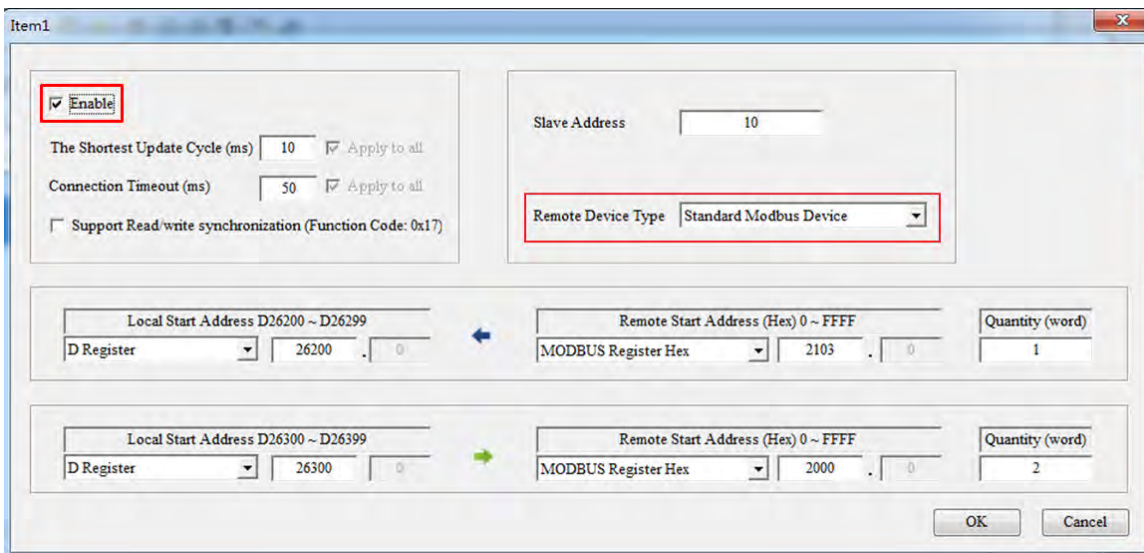

- Select Standard Modbus Device in the Remote Device Type and input the ASDA parameters and then select Enable.

Product	Slave ID	Communication protocol	Device from which data is read	Register in the CPU module	Device into which data is written	Register in the CPU module
ASDA	11	38400, ASCII, 7, E, 1	16#0101	D26210	16#0101	D26310

Item2

Enable

The Shortest Update Cycle (ms) Apply to all

Connection Timeout (ms) Apply to all

Support Read/write synchronization (Function Code: 0x17)

Slave Address

Remote Device Type

Local Start Address D26200 ~ D26299
 D Register

Remote Start Address (Hex) 0 ~ FFFF
 MODBUS Register Hex Quantity (word)

Local Start Address D26300 ~ D26399
 D Register

Remote Start Address (Hex) 0 ~ FFFF
 MODBUS Register Hex Quantity (word)

- Select PLC devices in the Remote Device Type and input the PLC parameters and then select Enable.

Product	Slave ID	Communication protocol	Device from which data is read	Register in the CPU module	Device into which data is written	Register in the CPU module
PLC	12	38400, ASCII, 7, E, 1	D100~D109	D26220~D26229	D200~D204	D26320~D26324

Item3

Enable

The Shortest Update Cycle (ms) Apply to all

Connection Timeout (ms) Apply to all

Support Read/write synchronization (Function Code: 0x17)

Slave Address

Remote Device Type

Local Start Address D26200 ~ D26299
 D Register

Remote Start Address D0 ~ D11999
 D Quantity (word)

Local Start Address D26300 ~ D26399
 D Register

Remote Start Address D0 ~ D11999
 D Quantity (word)

8) Select the Mode to "Always Enable"

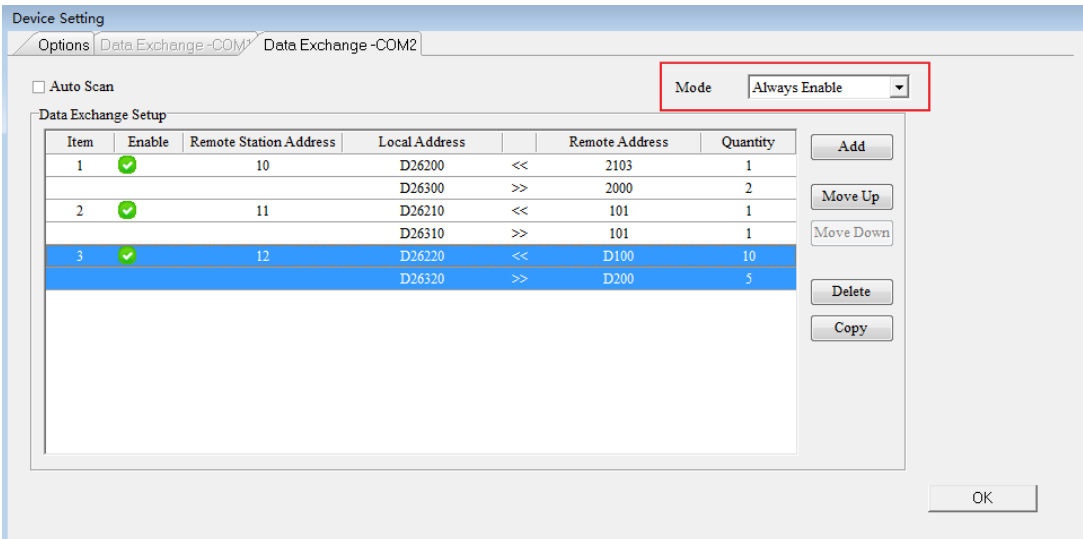

NOTE: If the Data Exchange Mode Control is set by the program, users can check and control the register address in the Normal Exchange Area page.

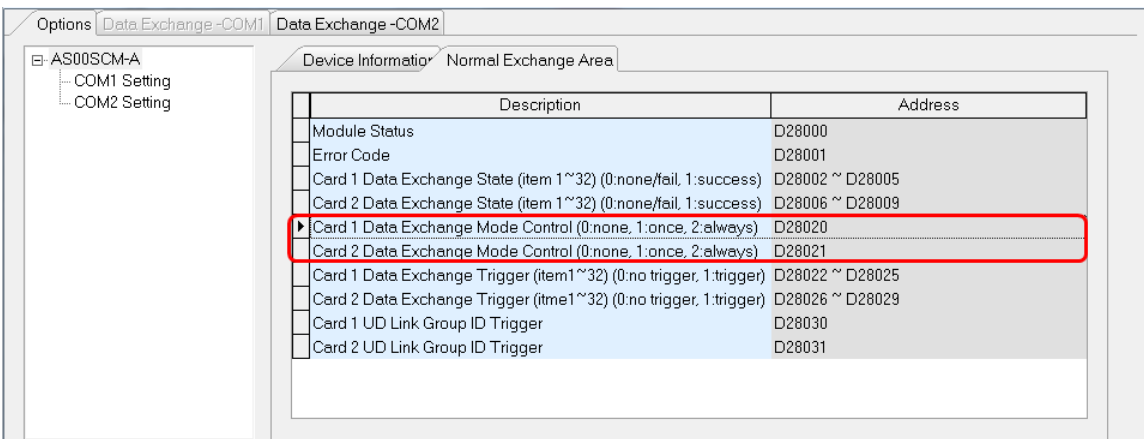

9) Download the parameters to AS00SCM.

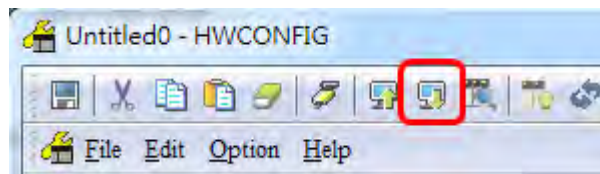

8

If the Mode is set to Always Enable, after downloading the parameters, the data exchange will be started right away.

If the Mode is set to Program Control, after downloading the parameters, the data exchange will be started by the program.

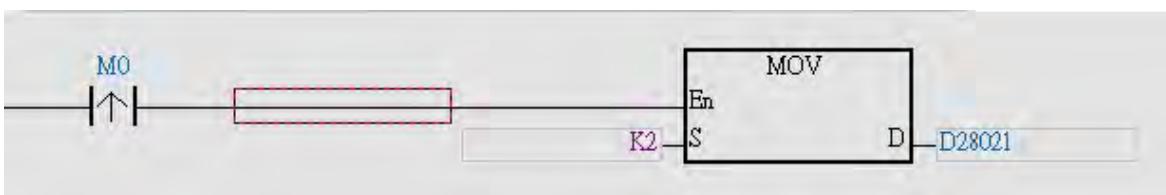

8.6.2 UD Link

This section introduces how AS00SCM is connected to other industrial products through a non-Modbus RS485 communication port on AS00SCM.

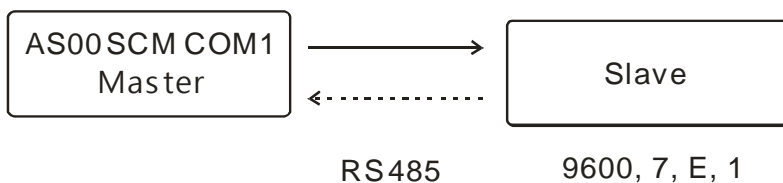

Communication of a Slave

Packet to send (→)	Packet to receive (←)	Description
POS, xxx, yyy	POS, ACT	Xxx and yyy are coordinates (0~999)

- 1) Drag AS00SCM to the system configuration area.

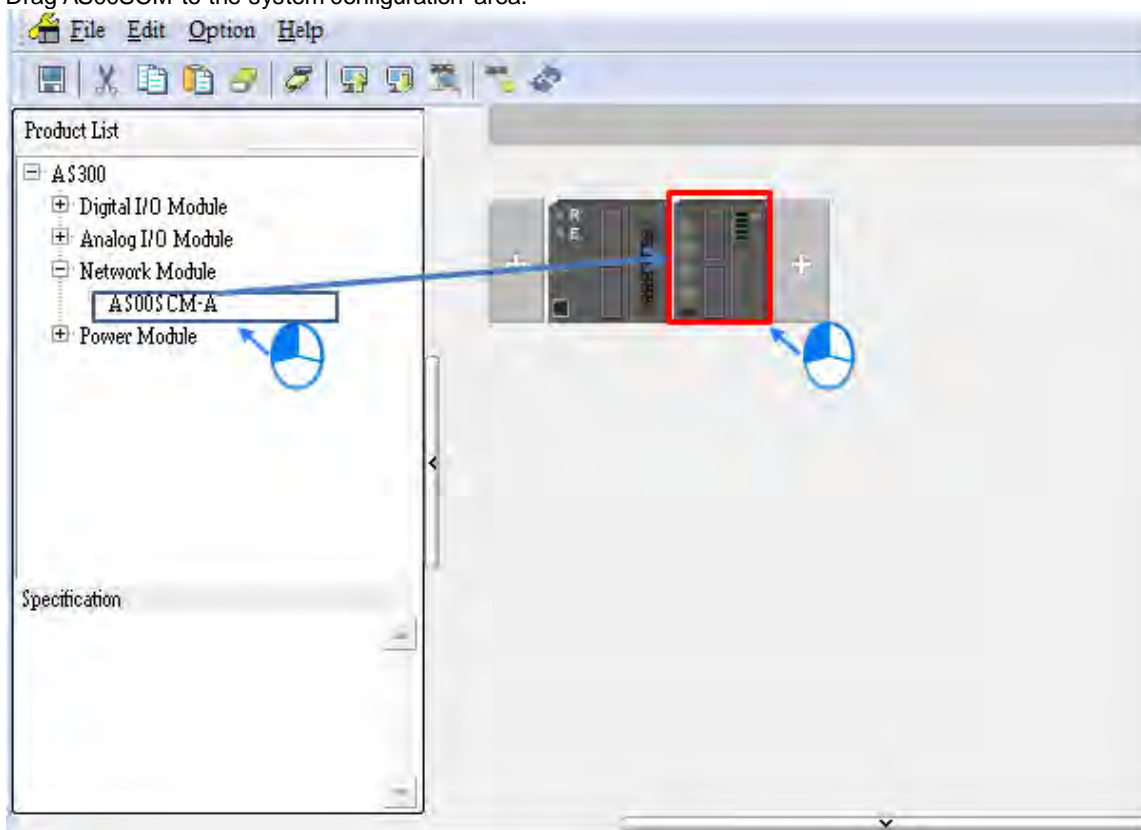

2) Double-click the SCM module to open the device setting for configurations.

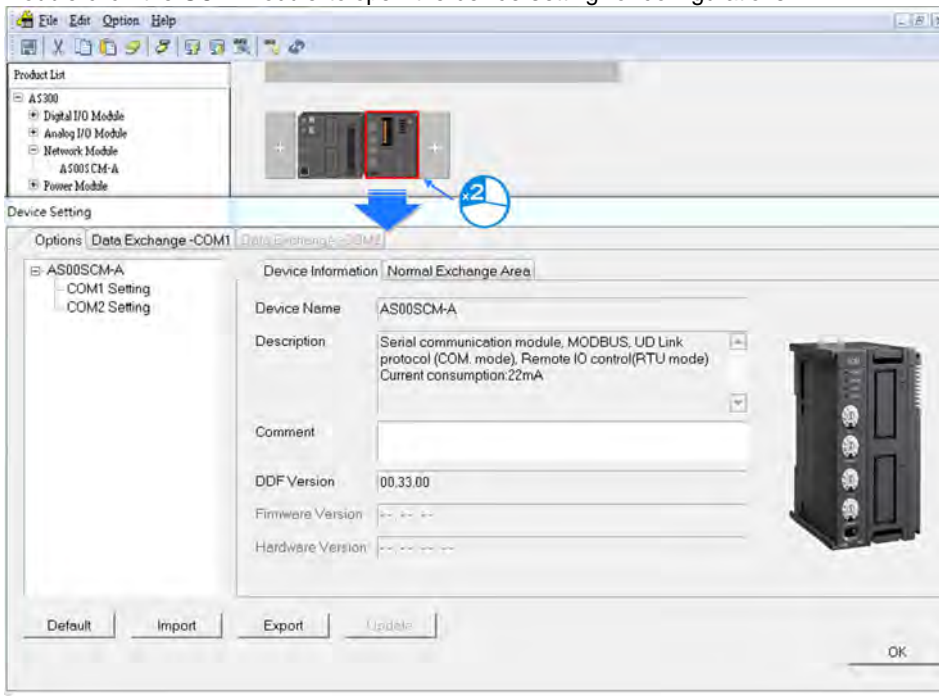

3) Select AS-F485 in the function card type for COM1. And its corresponding parameters will appear.

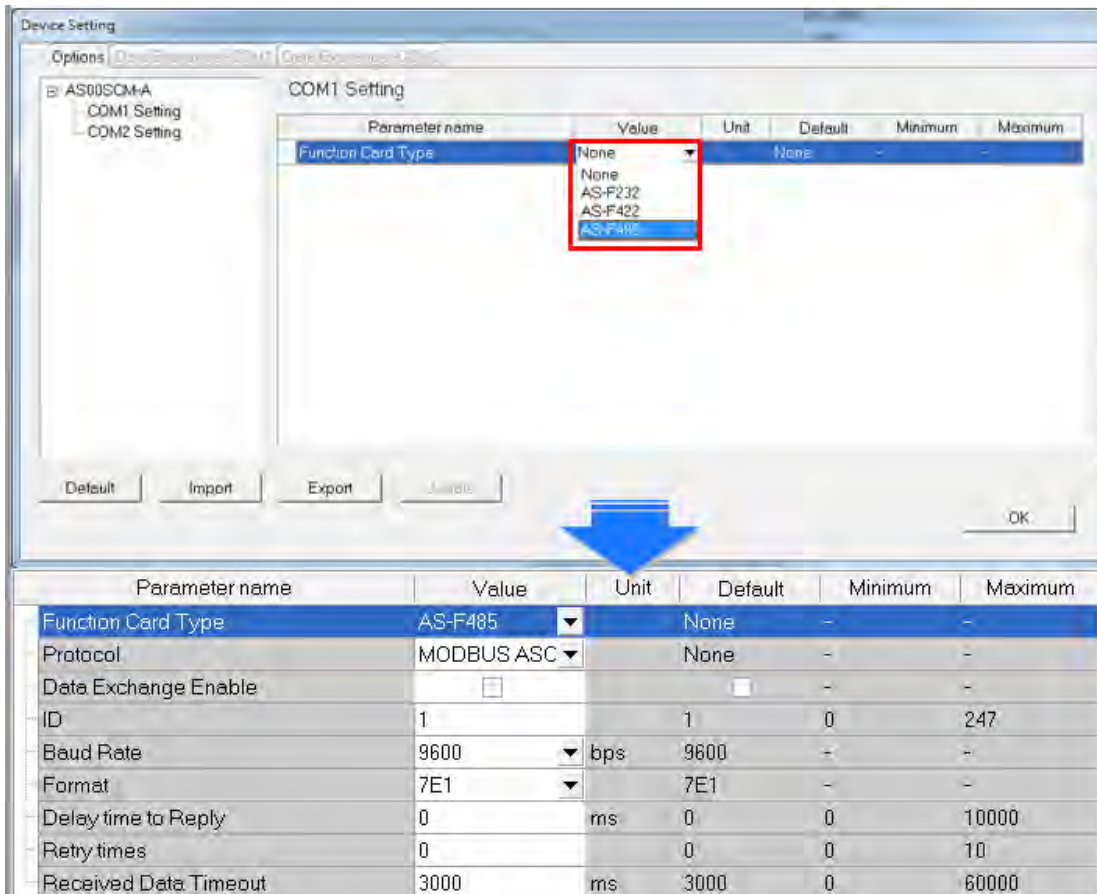

4) Select UD LINK in the protocol. Set up the baud rate and format. Click OK.

Parameter name	Value	Unit	Default	Minimum	Maximum
Function Card Type	AS-F485		None	-	-
Protocol	UD LINK		None	-	-
Baud Rate	9600	bps	9600	-	-
Format	7E1		7E1	-	-

5) Right-click AS00SCM module and then see and select the option Communication Software->SCMSOft.

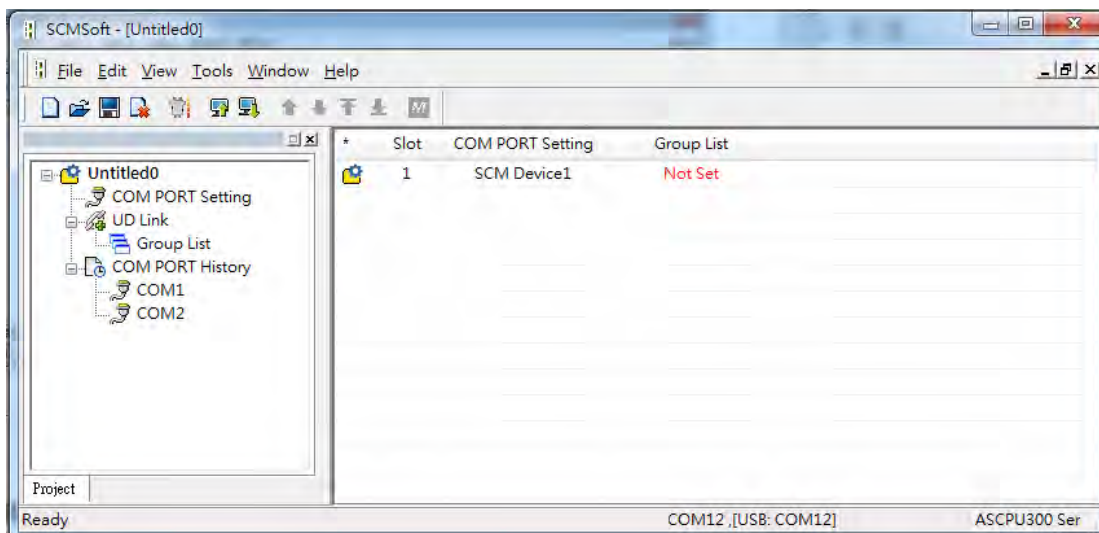
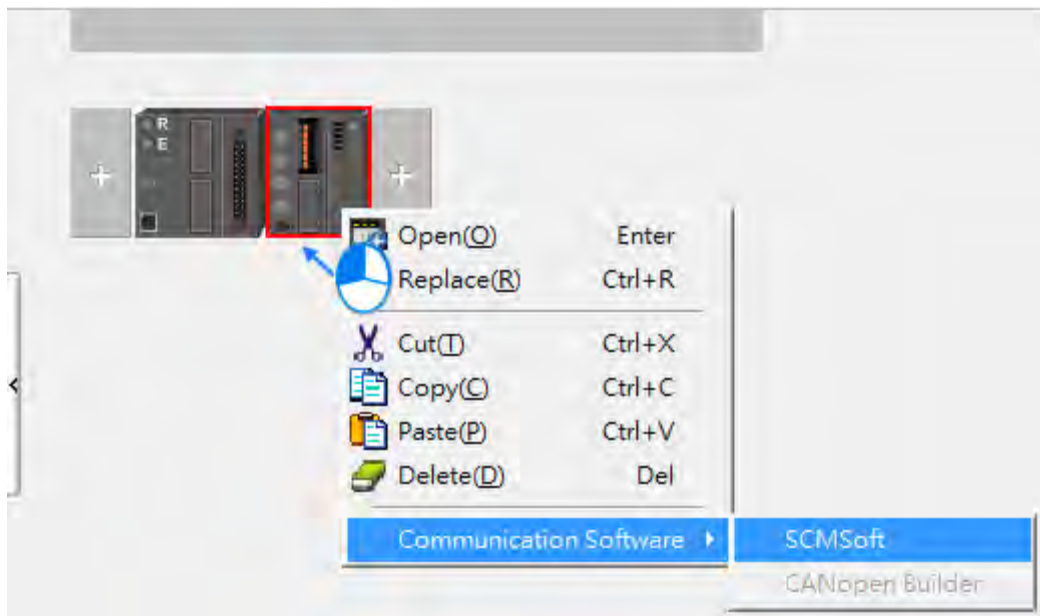

6) Click Group List to create a group list.

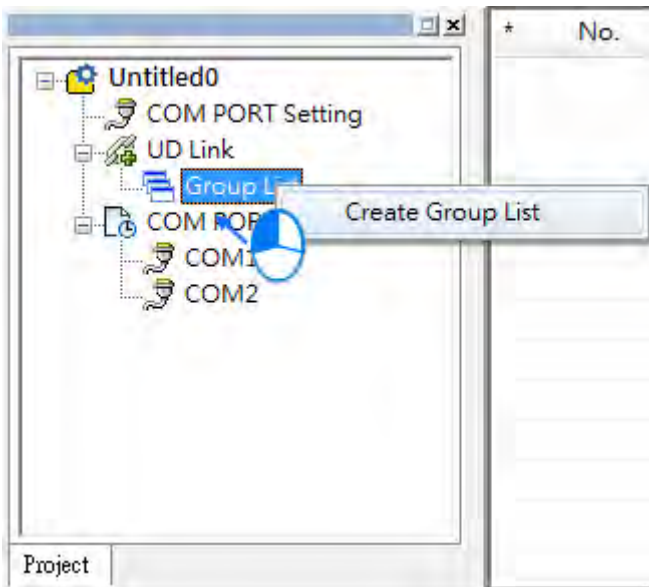

Give the group list a name (this example uses Slave_Simulation) and select 1 (COM 1) as the slot number.

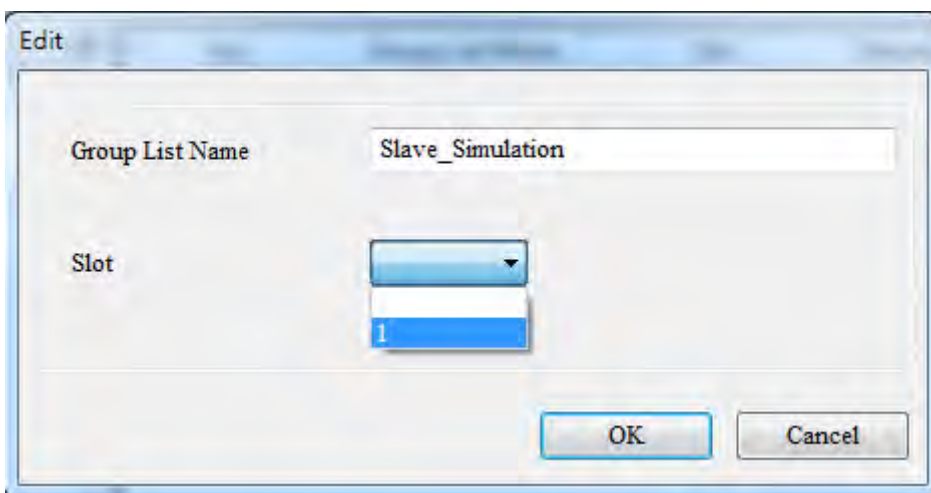

Create a group and name it as Master Send.

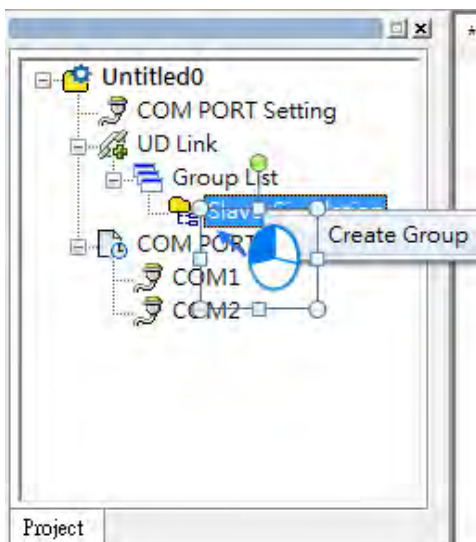

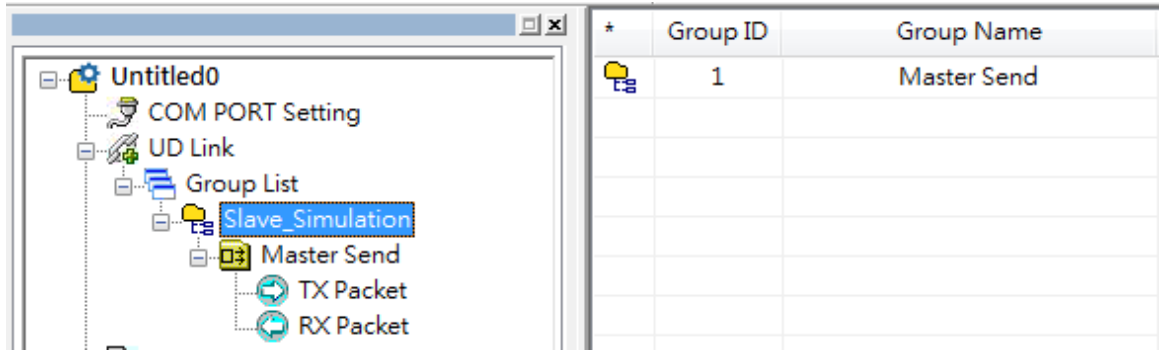

7) Edit the TX Packet and name it as TX POS Send. Double-click TX POS Send to open the Packet Edit window.

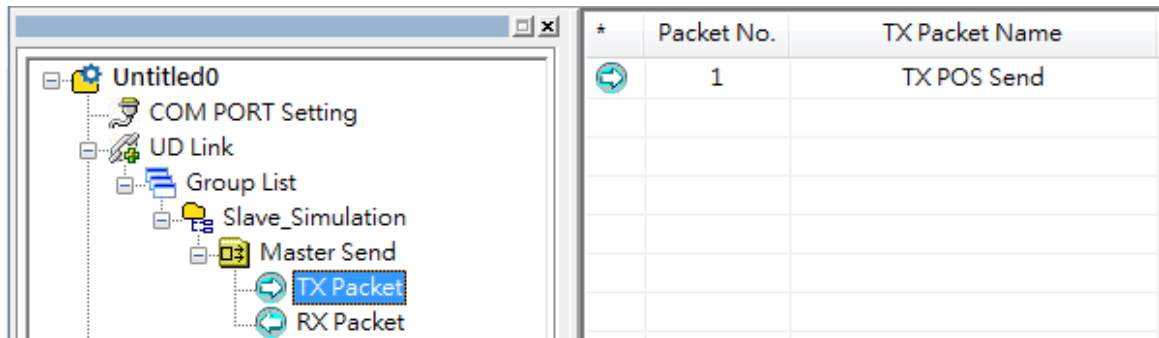

Edit the TX packet, "POS, xxx, yy" (the example below uses POS, 123, 123)

Click Constant and input POS

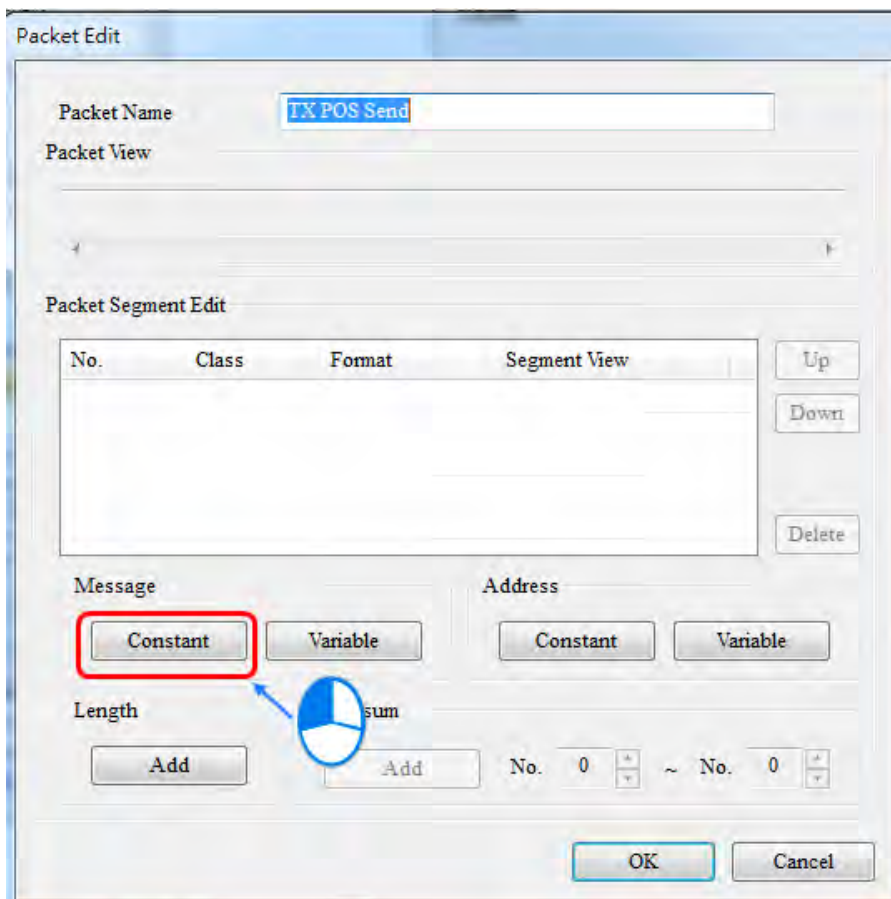

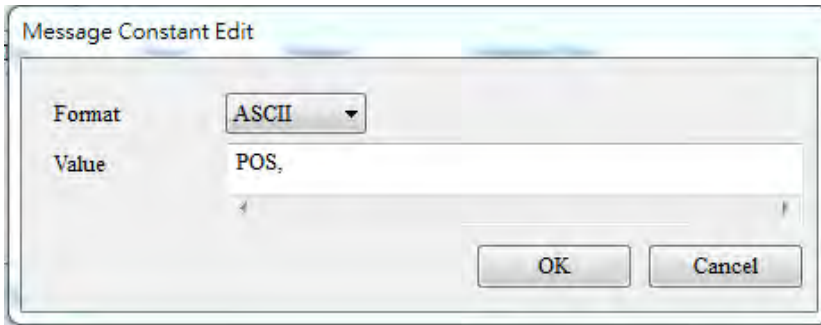

Click OK and then the packet contents can be seen in the packet view.

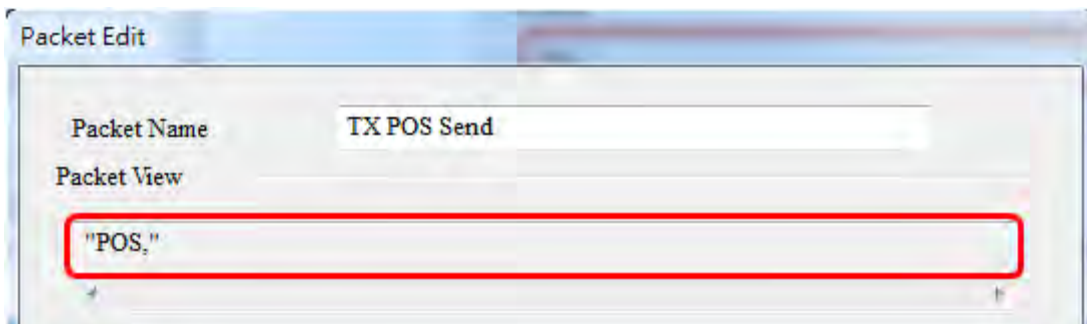

[xxx] is variables. Click Variables to edit. The value is obtained from the value in data register (D26100~D26199) via ISPSOft. The example here uses D26100: 16#3132 and D26101: 16#3300 and the value obtained is 123.

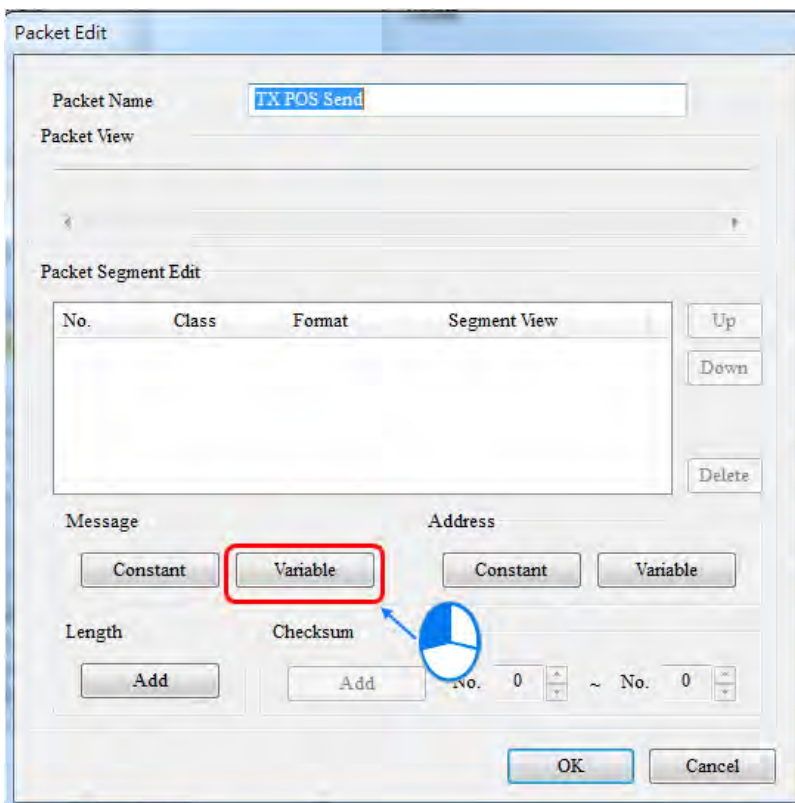

Input the data registers that contain the values you'd like to obtain. The example here uses D26100 and the obtained value length is 3 byte.

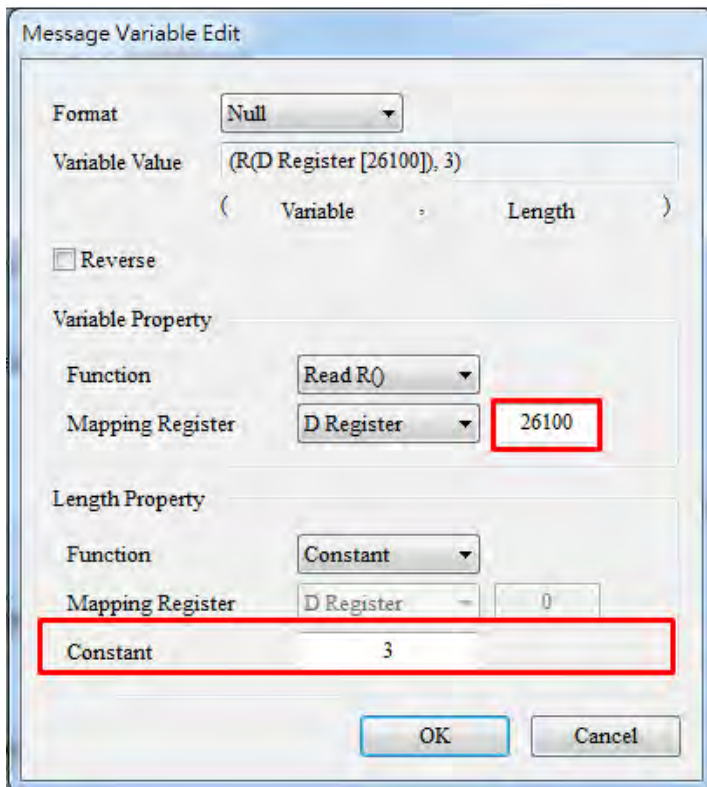

Click OK to see the values ("POS,"+ (R (D Register [26100], 3)) in the Packet View.

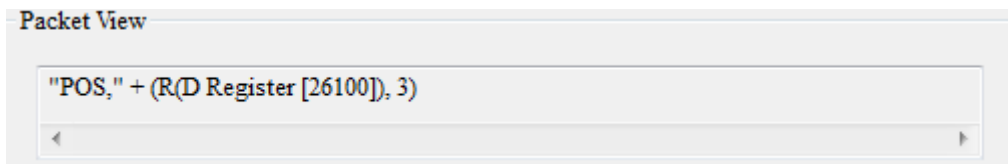

[·]: use constant to edit and the format is ASCII.

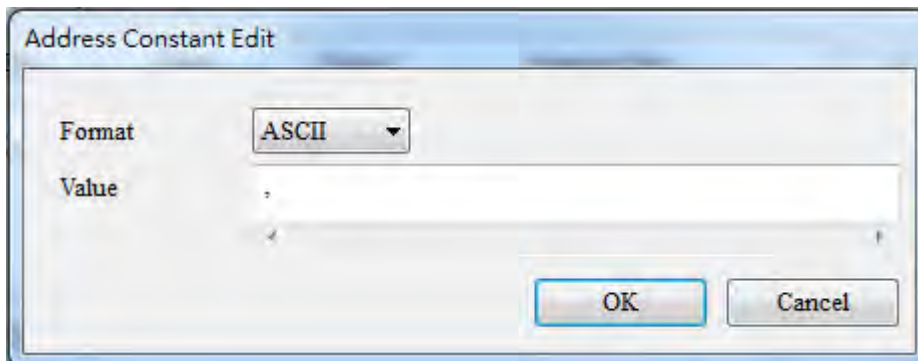

Click OK to see the values ("POS,"+ (R (D Register [26100], 3)) in the Packet View.

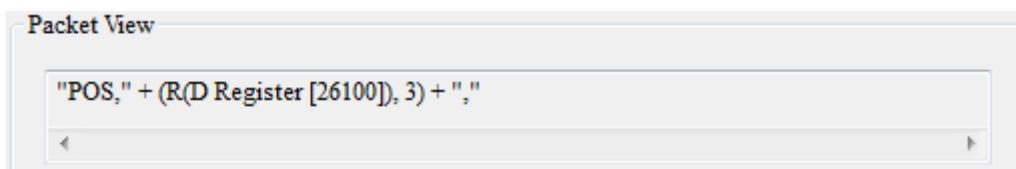

[yyy] is variables. Click Variables to edit. The value is obtained from the value in data register (D26100~D26199) via ISPSOft. The example here uses D26102: 16#3132 and D26103: 16#3300 and the value obtained is 123.

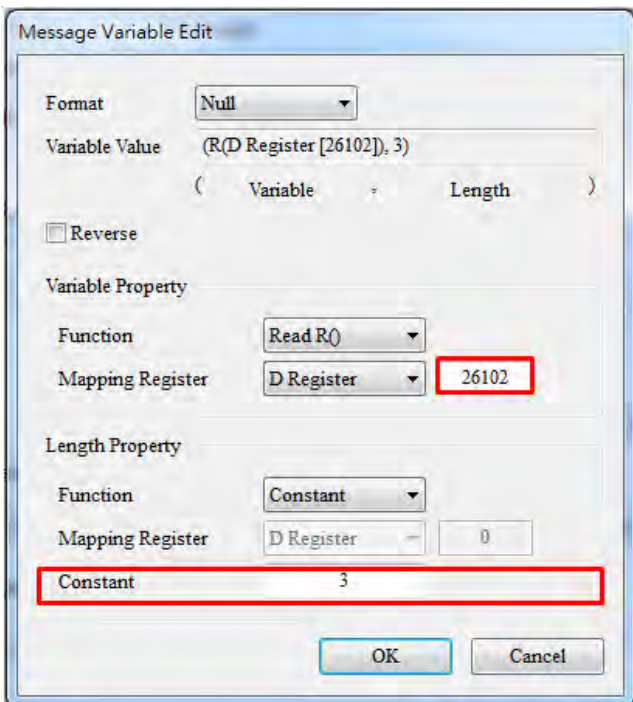

Input the data registers that contain the values you'd like to obtain. The example here uses D26102 and the obtained value length is 3 byte.

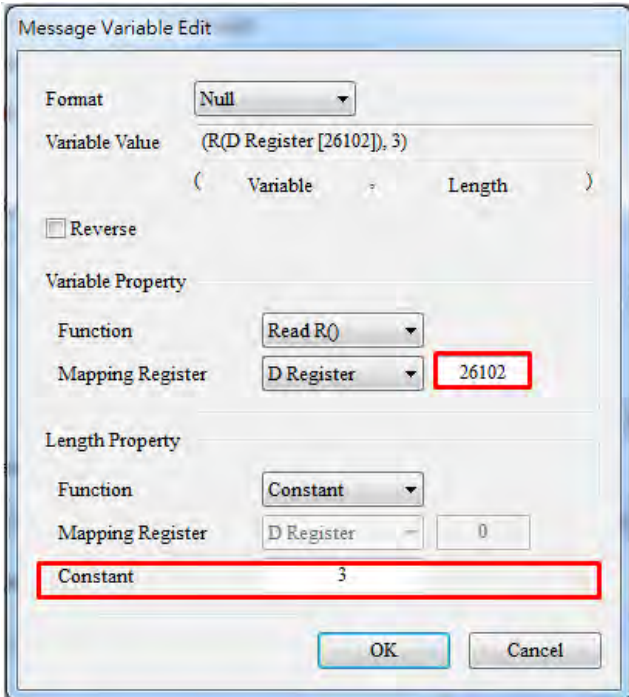

Click OK to see the values ("POS,"+ (R (D Register [26102], 3)) in the Packet View.

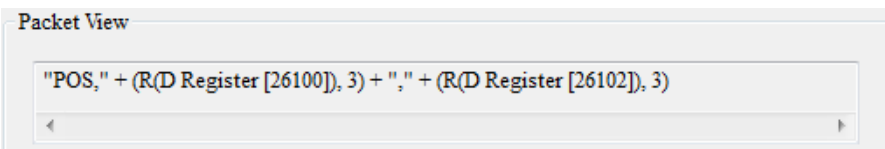

8) Edit the packet: create a packet and name it as "RX Result". Double-click it to open the editing window.

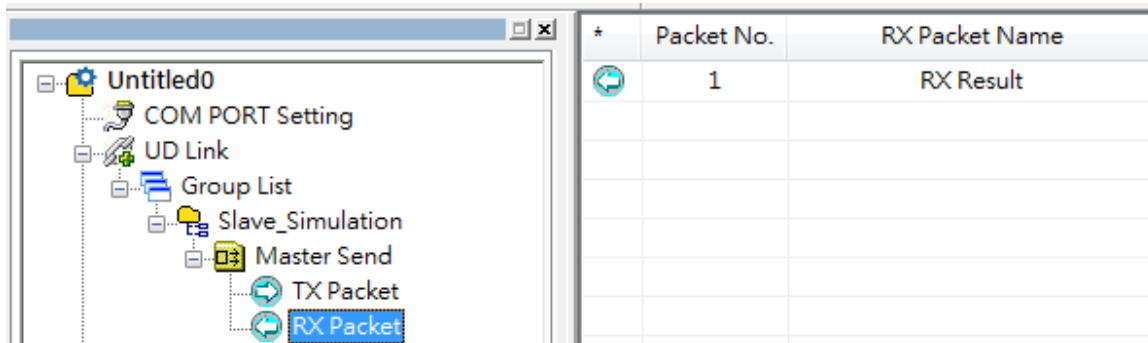

Write the sending packet into D26000 of the AS300 CPU. "*" means the length is not specified.

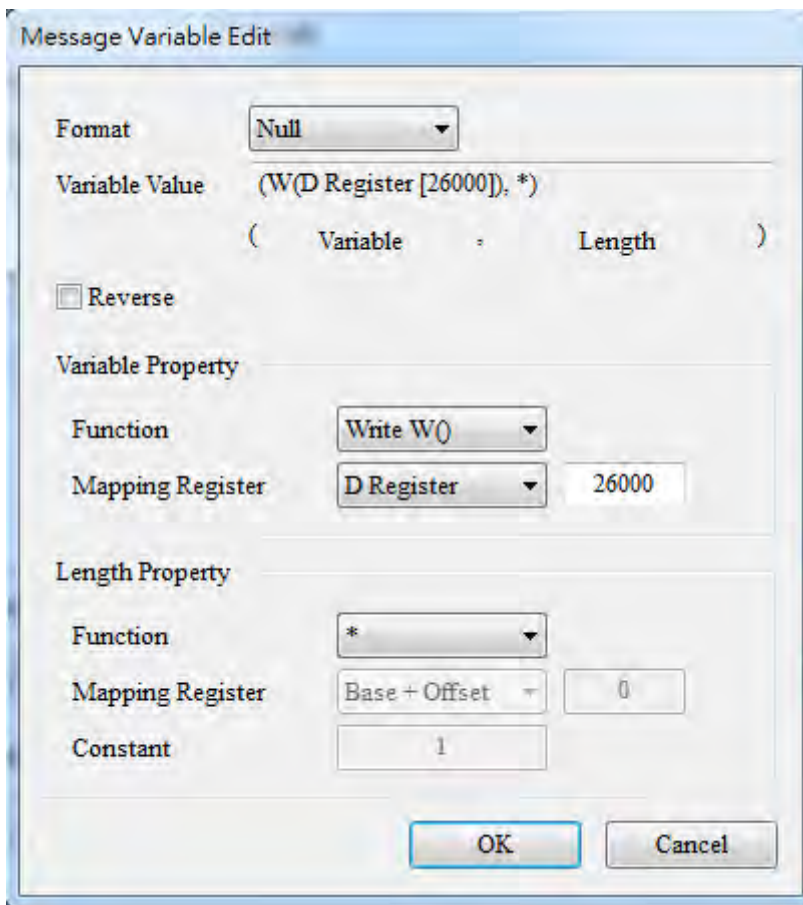

The packet view will be as below.

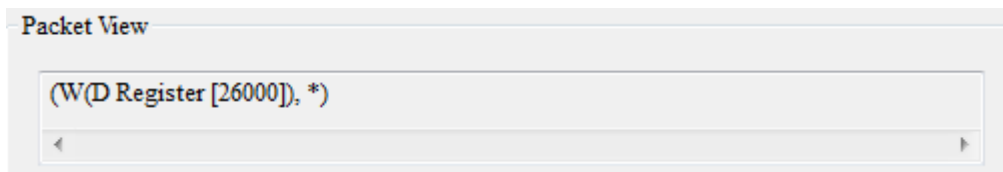

- 9) Create a command: right-click the Master Send to see and select the option Create Command. And a new command will be shown on the list.

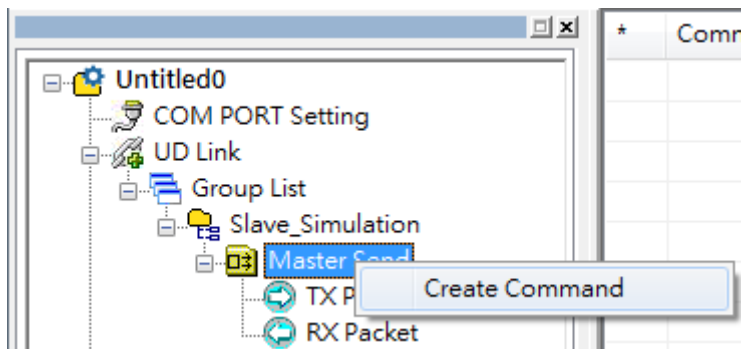

- Double-click the new command on the list to open the Command Edit window.

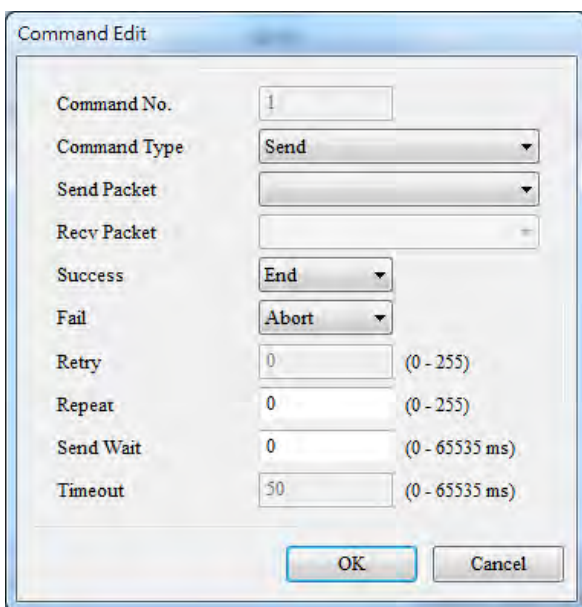
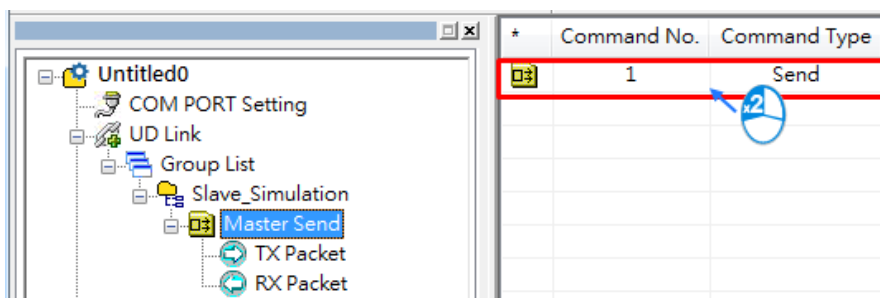

- Set up to send the packet of TX POS SEND and put the received contents in the devices assigned by RX Result.

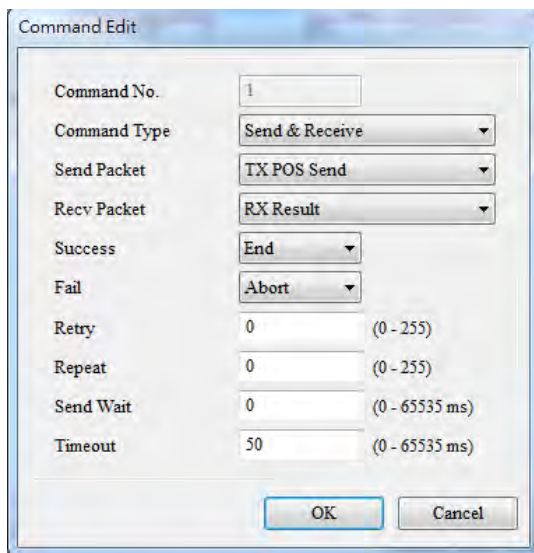

- Make sure the Group is in slot 1 (COM1).

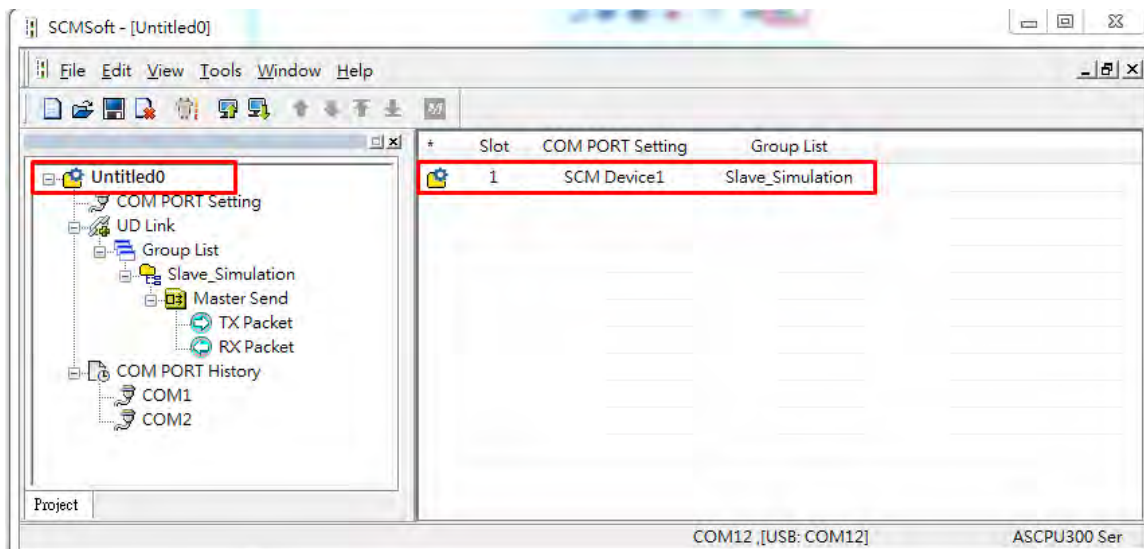

- 10) Download the parameters to AS00SCM.

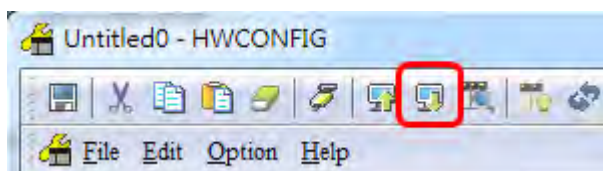

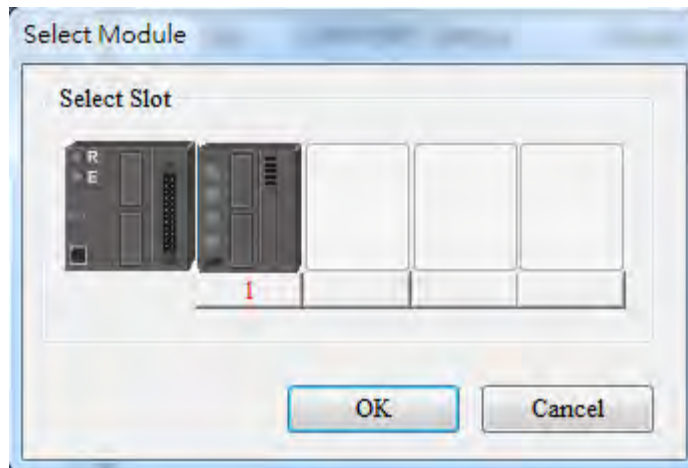

- 11) Set up the devices for UD Link Group ID Trigger in HWCONFIG. Once the AS00SCM module is created, the system will assign the corresponding addresses automatically.

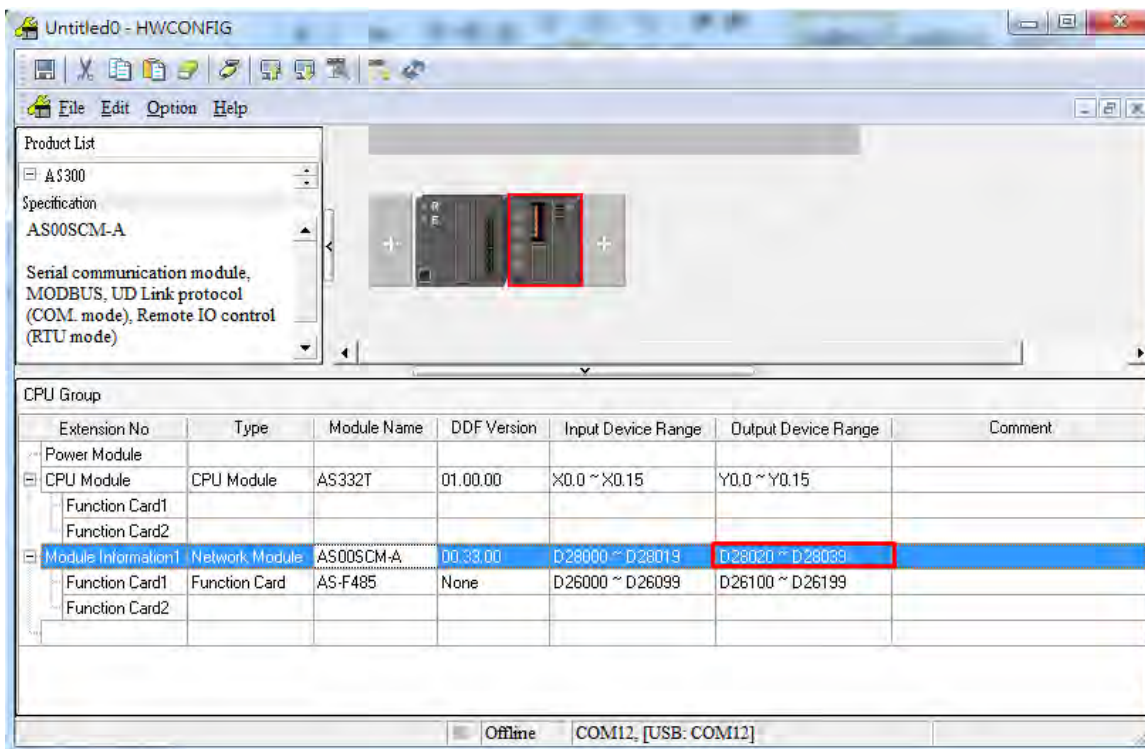

Double-click AS00SCM to open the device setting page. Users can see the Card 1 UD Link Group ID Trigger is in D28030. Write 1 into D28030 via ISPSOft to trigger and start data exchange.

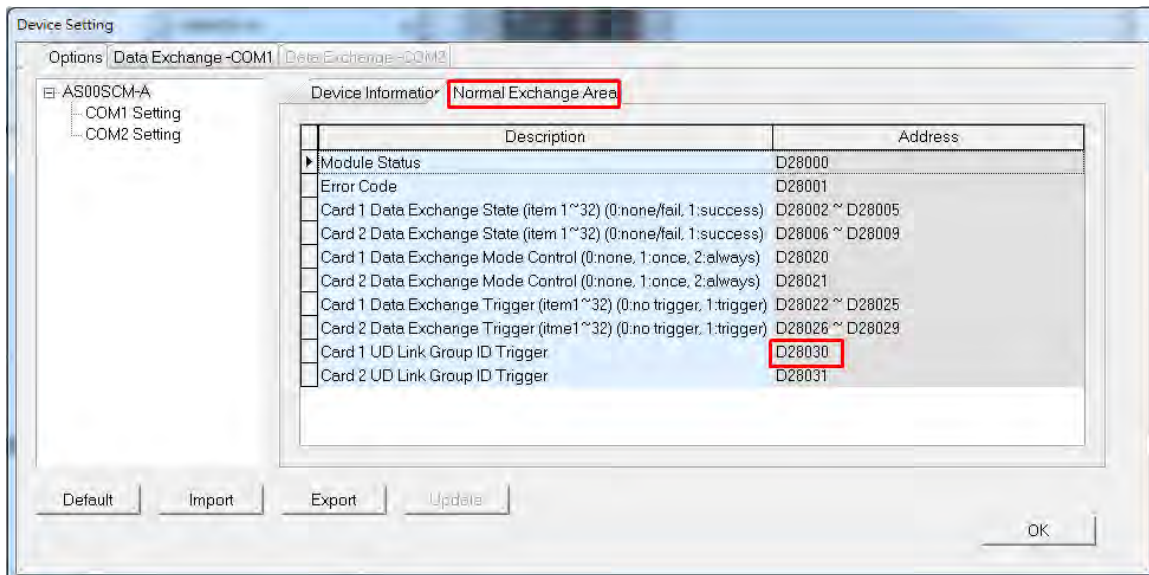

Users can use the monitor function in ISPSOft to see if the transmission works correctly.

D26100		12	123*	0.000	ASCII
D26101		3*	3*12	0.000	ASCII
D26102	Send	12	123*	0.000	ASCII
D26103		3*	3***	0.000	ASCII
D26000		PO	POS,	7400817295360.000	ASCII
D26001		S,	S,AC	12.207	ASCII
D26002	Receive	AC	ACT*	2203402895360.000	ASCII
D26003		T*	T***	0.000	ASCII

8.7 Error Code

The error flags and the UD Link statuses are stored in data registers. Users can modify the input device range by themselves.

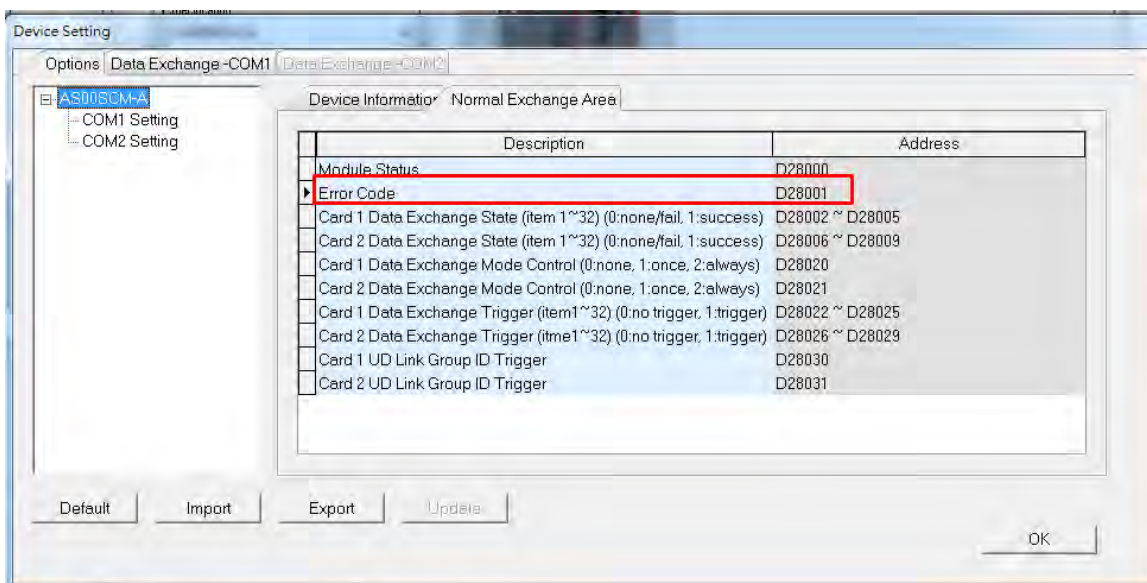
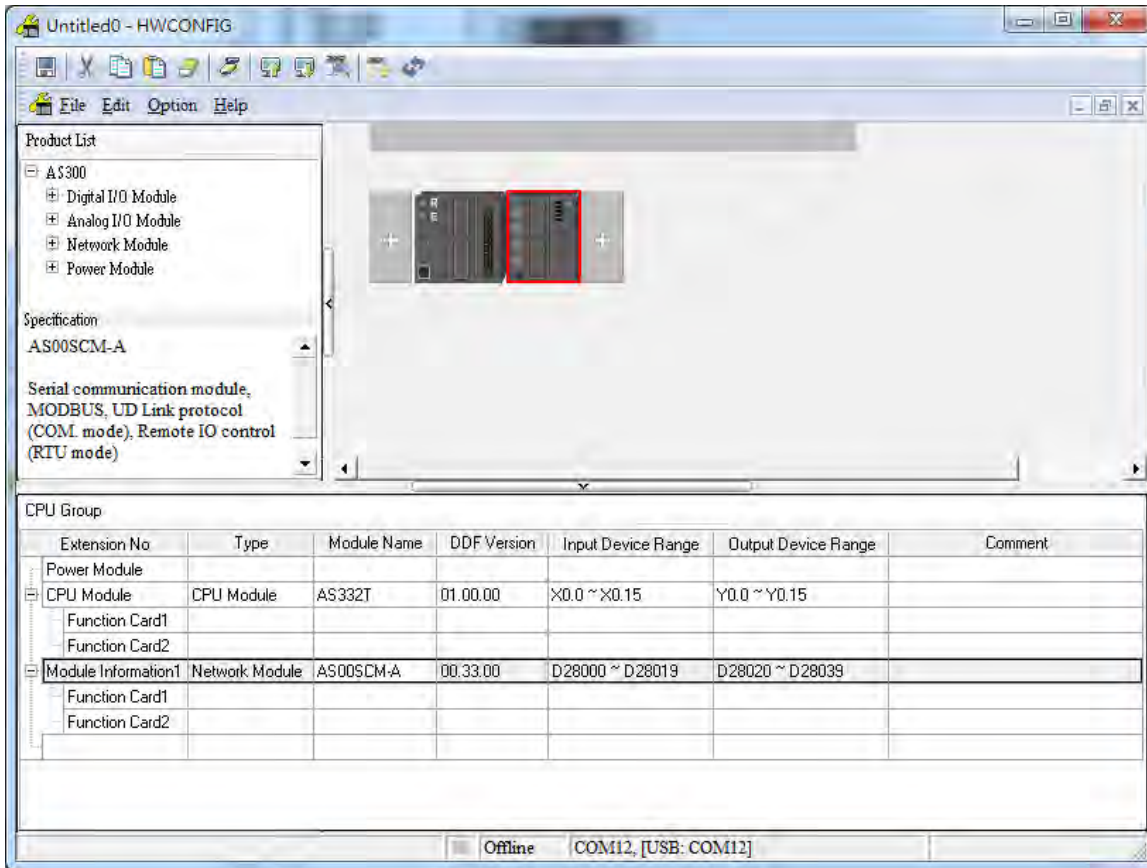

8.7.1 Troubleshooting for Module AS00SCM as a Communication Module

8.7.1.1 ERROR LED Indicator's Being ON

The following error codes are for users to identify possible errors occurred when the AS00SCM module is installed on the right side of the CPU module and acts as a communication module.

Error Code	Description	Solution
16#1605	Hardware failure	<ol style="list-style-type: none"> 1. Check if the module is securely installed. 2. Change and install a new AS00SCM or contact the factory.
16#1606	The setting of the function card is incorrect.	<ol style="list-style-type: none"> 1. Check if the function card is securely installed. 2. Change and install a new function card or contact the factory. 3. Check if the setting in HWCONFIG is consistent with the actual setting in the function card. 4. Change and install a new AS00SCM or contact the factory.

8.7.1.2 ERROR LED Indicator's Blinking Every 0.5 Seconds

The following error codes are for users to identify possible errors occurred when the AS00SCM module is installed on the right side of the CPU module and acts as a communication module.

Error Code	Description	Solution
16#1802	Incorrect parameters	Check the parameter in HWCONFIG, and the parameter. Download the parameter again.
16#1803	Communication timeout	<ol style="list-style-type: none"> 1. Check whether the communication cable is connected well. 2. Check if the station number and the communication format are correctly set. 3. Check if the connection with the function card is working fine.
16#1804	The setting of the UD Link is incorrect.	<ol style="list-style-type: none"> 1. Check the settings of the UD Link. 2. Check the settings to trigger warnings in the PLC.

The following error codes can only be viewed via SCMSOFT; when the following errors occurred, they will not be shown on the LED indicators and the system will not send the error messages to the CPU module.

Error Code	Description	Solution
16#0107	The settings in HWCONFIG and actual manual settings are not consistent for the function card 1.	Check the settings in HWCONFIG and actual manual settings for the function card 1.
16#0108	The settings in HWCONFIG and actual manual settings are not consistent for the function card 2.	Check the settings in HWCONFIG and actual manual settings for the function card 2.
16#0201	Incorrect parameters	Check the parameter in HWCONFIG, and the parameter. Download the parameter again.

Error Code	Description	Solution
16#0301	Function card 1 communication timeout	<ol style="list-style-type: none"> 1. Check if the station number and the communication format are correctly set. 2. Check if the connection with the function card is working fine.
16#0302	Function card 2 communication timeout	<ol style="list-style-type: none"> 1. Check if the station number and the communication format are correctly set. 2. Check if the connection with the function card is working fine.
16#0400	Invalid UD Link Group ID for the function card 1	<ol style="list-style-type: none"> 1. Check the settings of the UD Link. 2. Check the settings to trigger warnings in the PLC.
16#0401	Invalid UD Link Group ID for the function card 2	<ol style="list-style-type: none"> 1. Check the settings of the UD Link. 2. Check the settings to trigger warnings in the PLC.
16#0402	Invalid UD Link Command for the function card 1	<ol style="list-style-type: none"> 1. Check the settings of the UD Link. 2. Check the settings to trigger warnings in the PLC.
16#0403	Invalid UD Link Command for the function card 1	<ol style="list-style-type: none"> 1. Check the settings of the UD Link. 2. Check the settings to trigger warnings in the PLC.

8.7.2 Troubleshooting for Module AS00SCM as a Remote Module

Errors from the remote modules are regarded as warnings for AS CPU modules. The LED indicator of the CPU module will blink and the CPU module can still operate. Users can use the flag SM30 to work with the programs in the PLC to manage the ways to present the errors from the remote modules.

8.7.2.1 Error LED Indicator's Being ON

Error codes for the error type

Error Code	Description	Solution
16#1301	Hardware failure	<ol style="list-style-type: none"> 1. Check if the module is securely installed. 2. Change and install a new AS00SCM or contact the factory.
16#1302	The setting of the function card is incorrect.	<ol style="list-style-type: none"> 1. Check if the function card is securely installed with the AS-FCOPM card. 2. Change and install a new function card or contact the factory. 3. Check if the setting in HWCONFIG is consistent with the actual setting in the function card. 4. Change and install a new AS00SCM or contact the factory.

8.7.2.2 ERROR LED Indicator's Blinking Every 0.5 Seconds

Error codes for the warning type

Error Code	Description	Solution
16#1502	Incorrect parameters	Check the parameter in HWCONFIG, and the parameter. Download the parameter again.

Error Code	Description	Solution
16#1503	Extension module communication timeout	Make sure the module is well-connected to the CPU module and turn-on the modules again.

8.7.2.3 ERROR LED Indicator's Blinking Every 0.2 Seconds

This happens when the power supply of 24VDC for the remote module is not sufficient. Please check the power supply. If the power supply is normal, remove the extension module from the CPU module and then check if the SCM remote module is out of order. The error codes below are of the warning types.

Error Code	Description	Solution
16#1303	24VDC power supply is not sufficient and then is recovered from a low-voltage less than 10ms situation.	Check whether the 24 V power supply to the module is normal.

MEMO

Chapter 9 Function Cards

Table of Contents

9.1	Introduction	9-2
9.2	Specification and Function.....	9-2
9.2.1	AS-F232	9-2
9.2.2	AS-F422	9-2
9.2.3	AS-F485	9-2
9.2.4	AS-F2AD.....	9-3
9.2.5	AS-F2DA.....	9-3
9.2.6	AS-FCOPM	9-4
9.3	Profiles and Dimensions	9-4
9.3.1	AS-F232	9-4
9.3.2	AS-F422/AS-F485/AS-F2AD/AS-F2DA.....	9-4
9.3.3	AS-FCOPM	9-5
9.4	Wiring.....	9-6
9.4.1	AS-F2AD.....	9-6
9.4.2	AS-F2DA.....	9-7
9.5	HWCONFIG in ISPSOft	9-7
9.5.1	Initial Setting	9-7

9.1 Introduction

Function cards are the extension cards such as analog input/output (AI/AO) and communication cards for AS series PLC.

9.2 Specification and Function

9.2.1 AS-F232

AS series PLC is built with COM1 (RS-485), and COM2 (RS-485). Users can use this extension card for communication via different interface such as RS-232, PC and so on. Other than the different communication interface, the communication functions including are the same as the built-in ones; the communication port can be set as a Slave or a Master node. After installing the extension card, go to the HWCONFIG in the ISPSOft for communication setups.

■ Wiring example

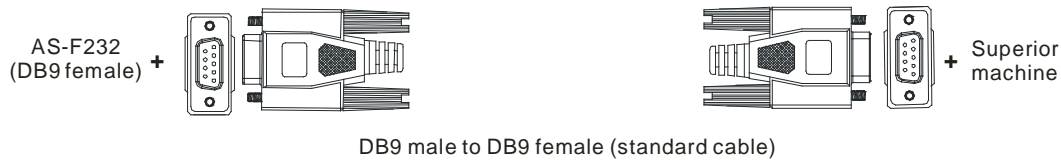

9.2.2 AS-F422

Users can use this extension card for communication with Delta HMI series or other devices via RS-422 communication port. Other than the different communication interface, the communication functions including are the same as the built-in ones; the communication port can be set as a Slave or a Master node. After installing the extension card, go to the HWCONFIG in the ISPSOft for communication setups.

■ Wiring example of the communication with Delta HMI DOPA series via COM2

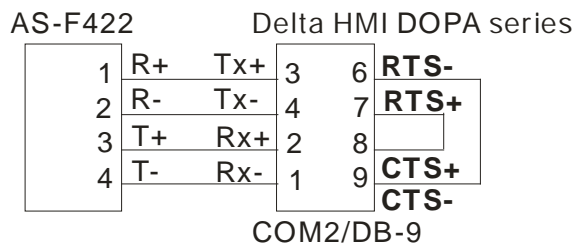

9.2.3 AS-F485

With its own standalone communication port, it can work independently and can be set as a Slave or a Master node. After installing the extension card, go to the HWCONFIG in the ISPSOft for communication setups.

■ Wiring example

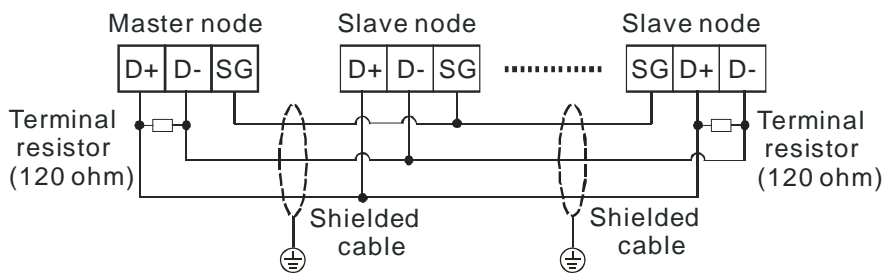

9.2.4 AS-F2AD

2 analog signal input channels:

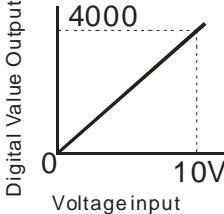
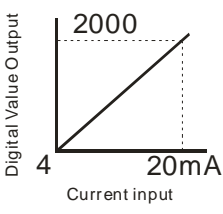
Item	Voltage Input		Current input	
Analog Signal	DC 0~+10V		DC 4~20mA	
Resolution	12-bit		11-bit	
Input impedance	2M Ω		250 Ω	
Conversion time	3ms / CH			
Characteristic curve				
Digital value output	Card1	SR168 (CH1)	SR169 (CH2)	
	Card2	SR170 (CH1)	SR171 (CH2)	

Users can use the program to read the values in SR to obtain the corresponding A/D conversion value for the channel.

9.2.5 AS-F2DA

2 analog signal output channels:

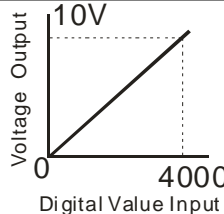
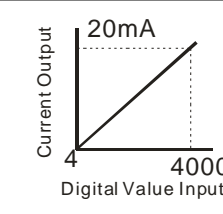
Item	Voltage output		Current output	
Analog Signal	DC 0~+10V		DC 4~20mA	
Resolution	12-bit		12-bit	
Input impedance	$\geq 1k\Omega$		$\leq 500\Omega$	
Conversion time	2ms / CH			
Characteristic curve				
Digital value output	Card1	SR172 (CH1)	SR173 (CH2)	
	Card2	SR174 (CH1)	SR175 (CH2)	

Users can use the instruction MOV to move the value to the SR to obtain the corresponding voltage output value.

9.2.6 AS-FCOPM

With its own standalone communication port, it can work independently and can be set as a Slave or a Master node. After installing the extension card, go to the HWCONFIG in the ISPSOft for communication setups.

■ Wiring example

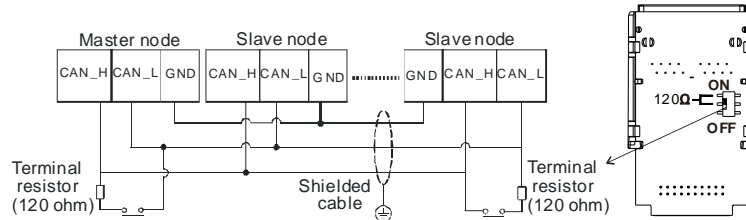

9.3 Profiles and Dimensions

9.3.1 AS-F232

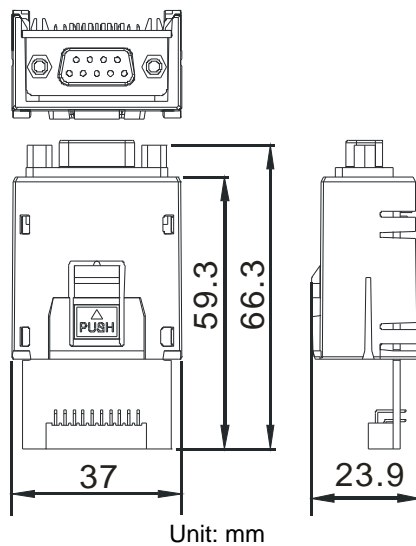

9.3.2 AS-F422/AS-F485/AS-F2AD/AS-F2DA

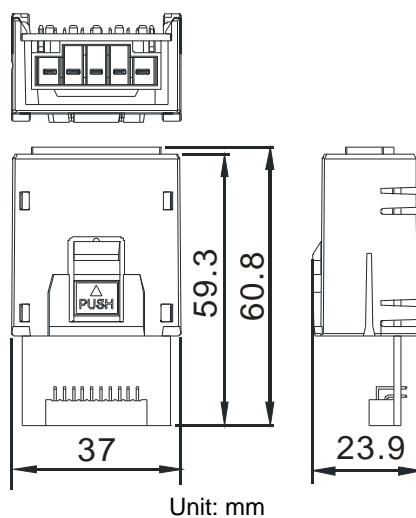

9.3.3 AS-FCOPM

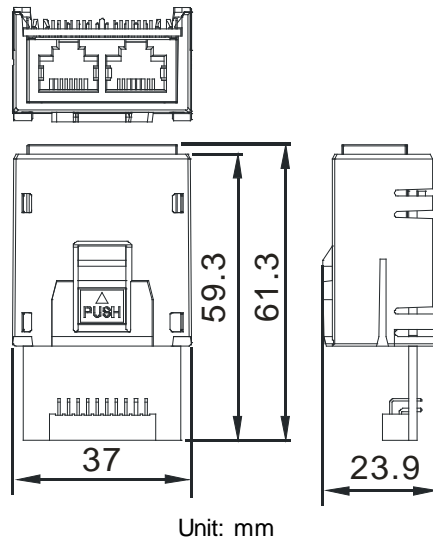

9.4 Wiring

9.4.1 AS-F2AD

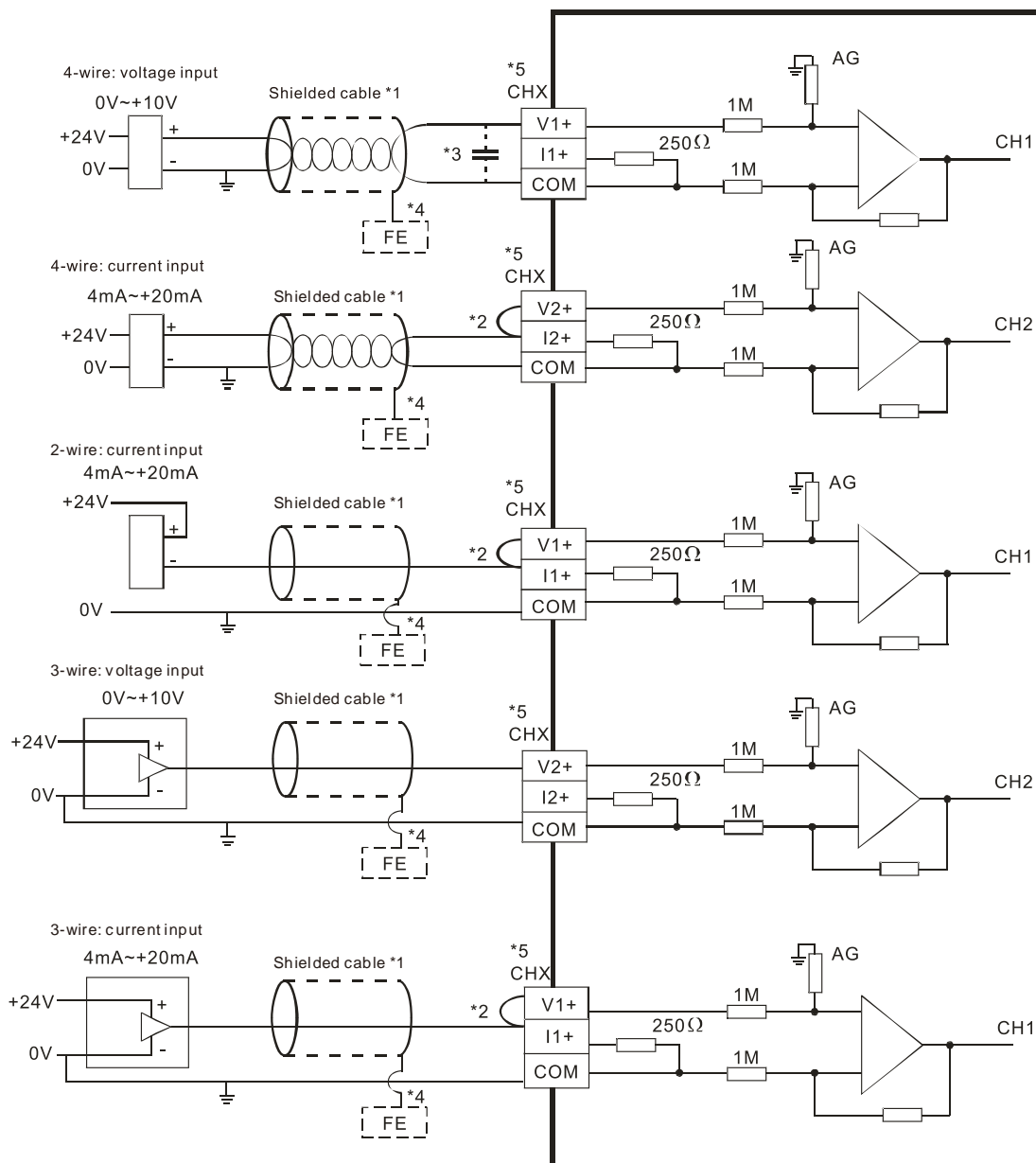

- *1. Please use shielded cables to isolate the analog input signal cable from other power cables.
- *2. If the module is connected to a current signal, the terminals V_n and I_n+ (n=1~2) must be short-circuited.
- *3. If the ripple in the input voltage results in the noise interference with the wiring, please connect the module to the capacitor having a capacitance in the range of 0.1 μF to 0.47 μF with a working voltage of 25 V.
- *4. Please connect the shielded cable to the terminal FE.
- *5. The wording "CHX" indicates that the 5 wiring methods listed above can be used for every input channel.

9.4.2 AS-F2DA

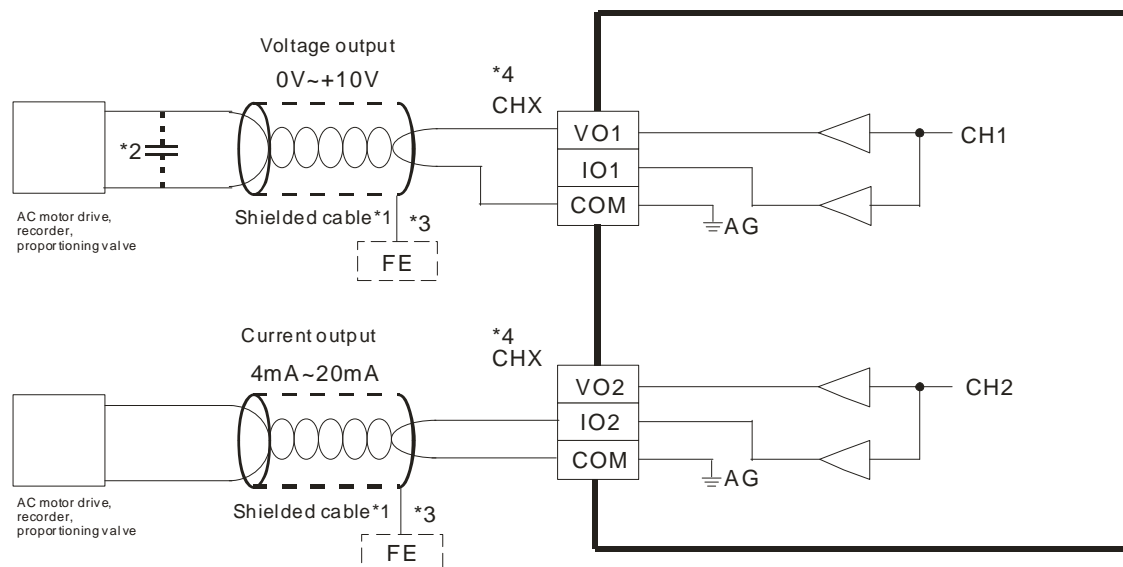

- *1. Please use shielded cables to isolate the analog input signal cable from other power cables.
- *2. If the ripple in the input voltage results in the noise interference with the wiring, please connect the module to the capacitor having a capacitance in the range of 0.1 μF to 0.47 μF with a working voltage of 25 V.
- *3. Please connect the shielded cable to the terminal FE.
- *4. The wording "CHX" indicates that the 2 wiring methods listed above can be used for every input channel.

9.5 HWCONFIG in ISPSOft

9.5.1 Initial Setting

- (1) Start ISPSOft, and then double-click **HWCONFIG**.

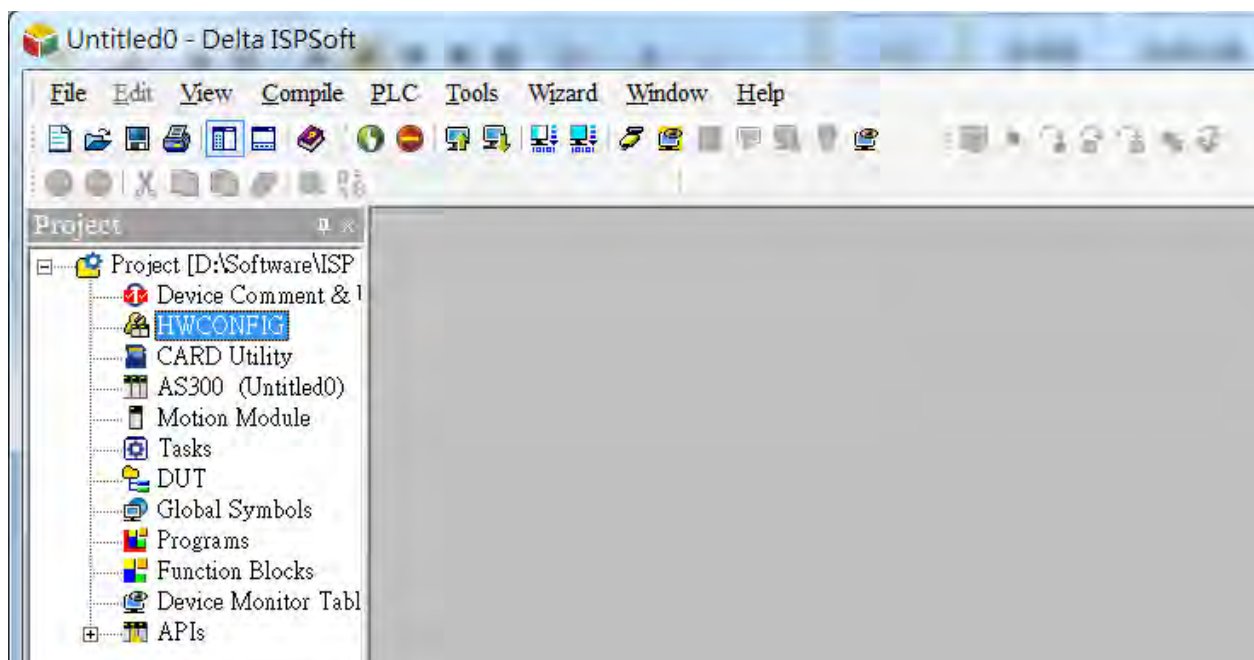

(2) Selecting a function card on the module.

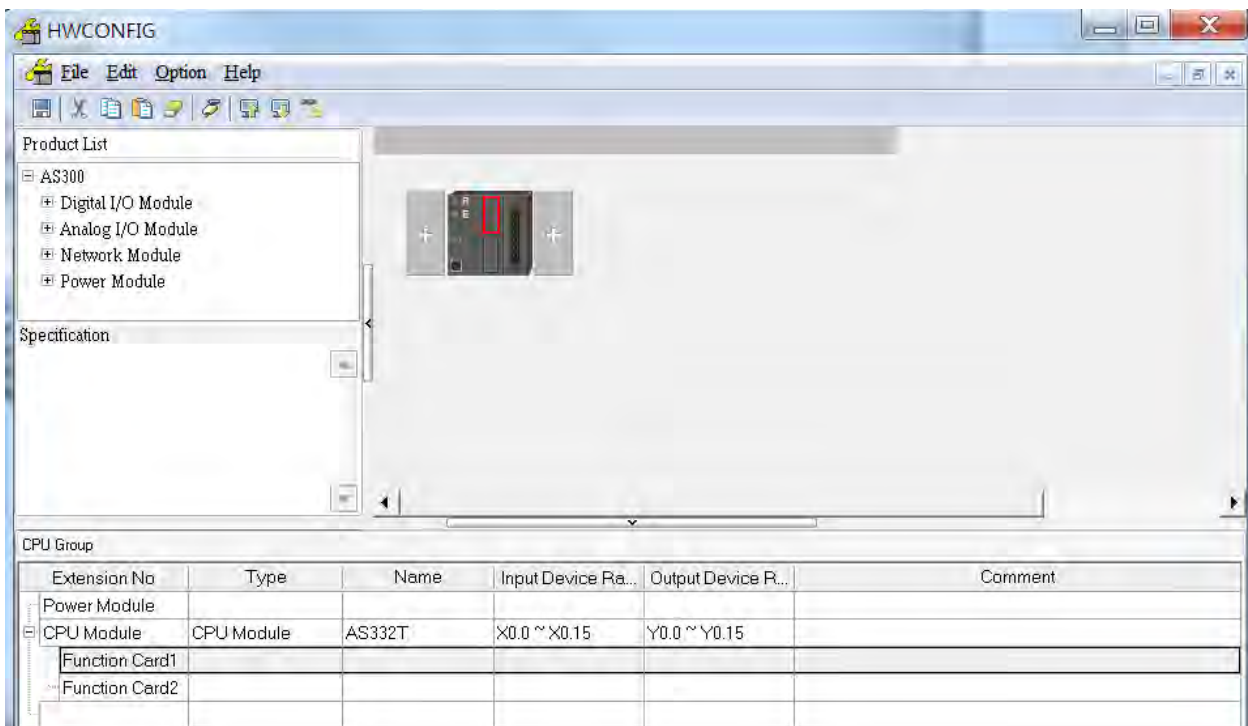

(3) Double-click the function card to open the device setting page.

Card1 Detect mode: auto detect or select the function card model.

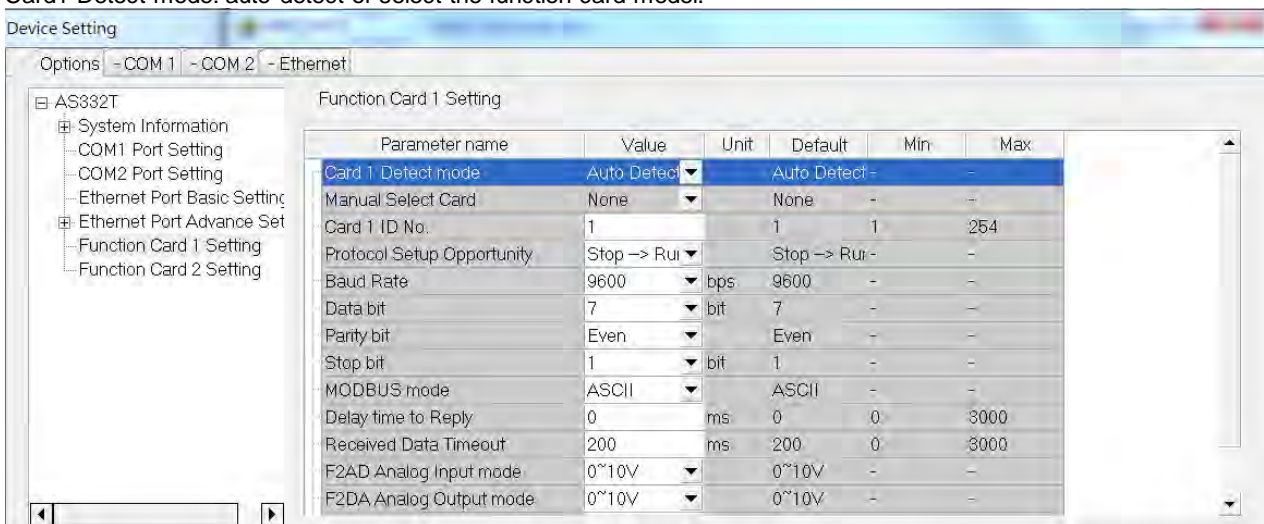

- (a) When the function card is AS-F232, AS-F422 or AS-F485. Users can set up the communication related settings in the area within the red box.

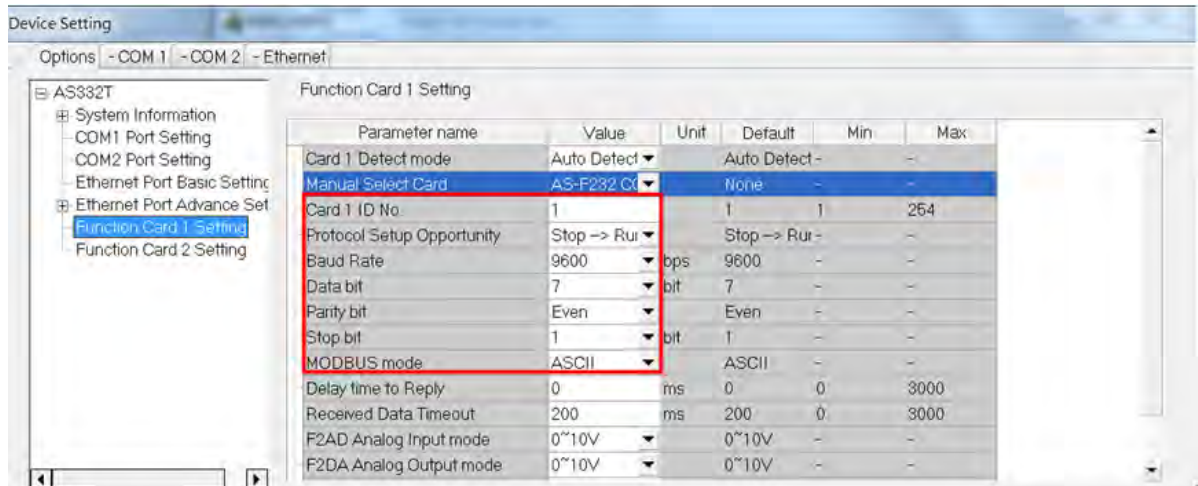

- (b) Function card AS-FCOM can only be installed in function card slot 2.

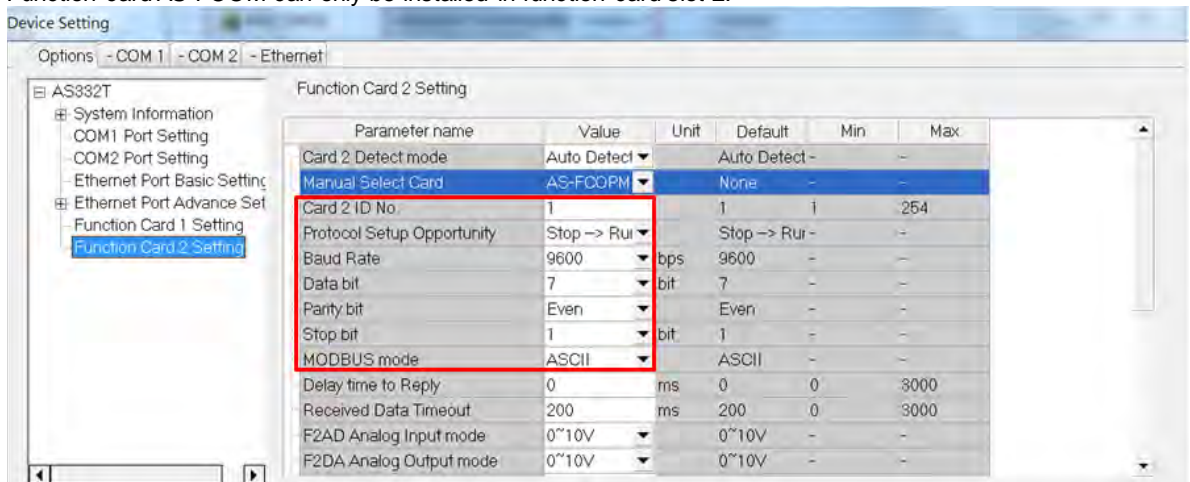

Set up the communication related settings in the area within the red box.

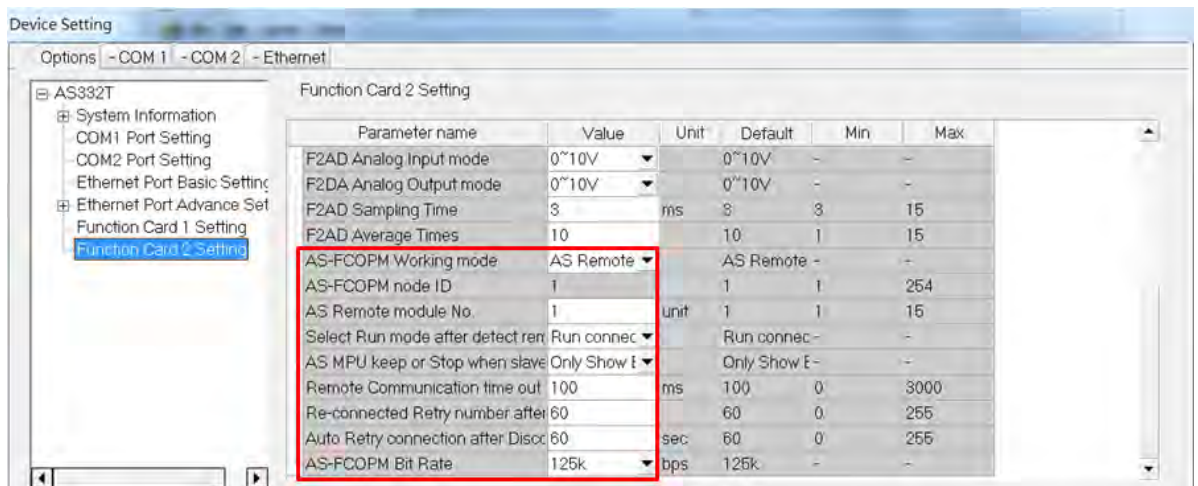

- (c) When the function card is AS-F2AD or AS-F2DA. Users can set up the communication related settings in the area within the red box.

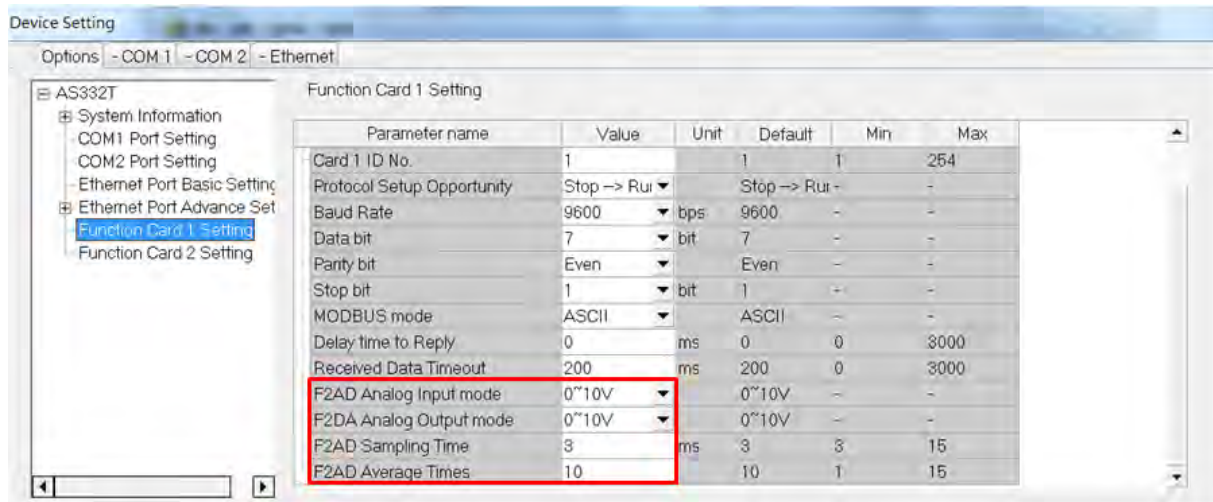

- (d) Click OK to confirm the settings.

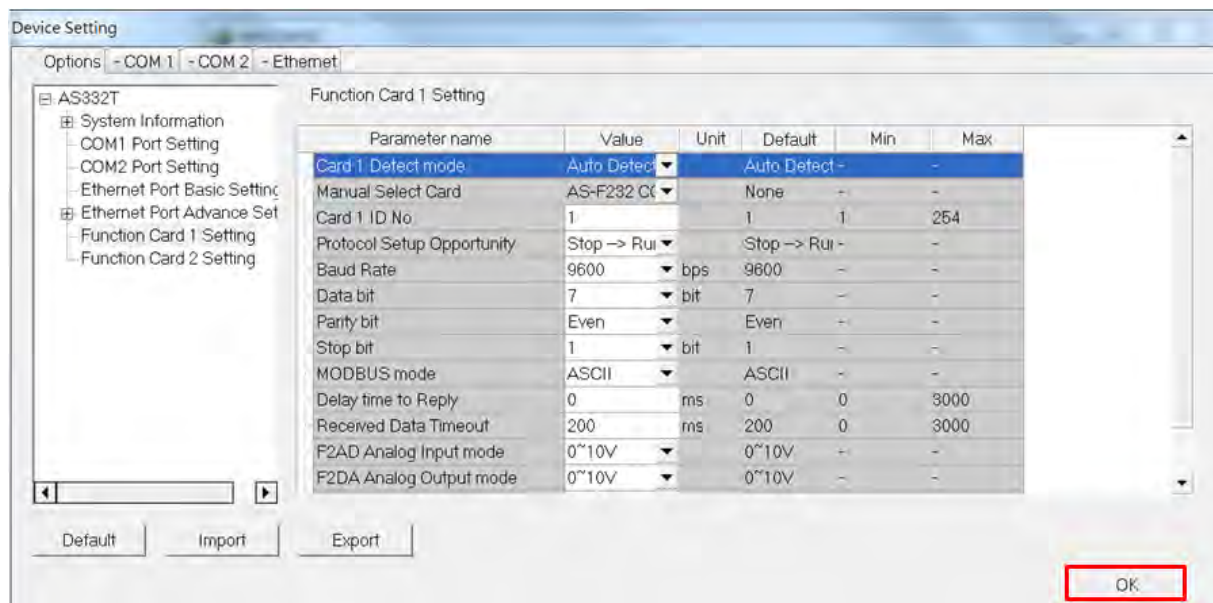

- (4) Click **Download** on the toolbar to download the parameters. (The parameters cannot be downloaded when the CPU module runs.)

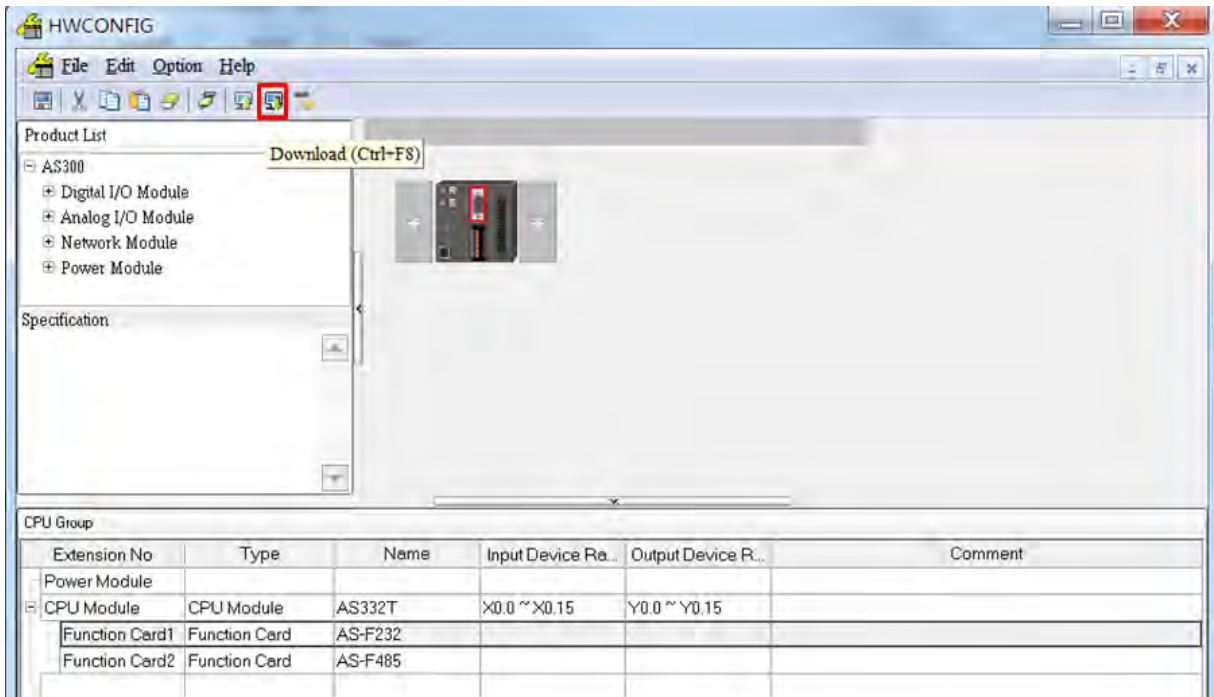

MEMO