

DVS Series Unmanaged Industrial Ethernet Switches User's Manual



DVS Series Unmanaged Industrial Ethernet Switches

User's Manual

Table of Contents

Chapter 1 Overview	
1.1 Features	1-2
1.2 Package Checklist	1-2
Chapter 2 Hardware Description	
2.1 Panel Layout	2-2
2.2 Dimension	2-24
2.3 LED Indicators	2-25
2.4 Wiring the Redundant Power Inputs	2-26
2.5 Wiring the Alarm Contact	2-27
2.6 Ethernet Interface	2-27
2.7 DIP Switch Setting	2-28
Chapter 3 Installation	
3.1 DIN-Rail Mounting	3-2
3.2 Wall Mounting	3-3
Chapter 4 Functional Description	
4.1 Auto MDI/MDI-X Connection	4-2
4.2 Auto-Negotiation and Speed Sensing	4-2
4.3 Stored and Forward	4-2
4.4 Addresses Capability and Learning	4-2
4.5 Quality of Service and VLAN Tagging	4-2
4.6 Broadcast Control	4-2



Chapter 1 Overview

Table of Contents

1.1	Features	1-2
1.2	Package Checklist.....	1-2



FCC Interference Statement

This equipment has been tested and found to comply with the limits for a class B digital device, pursuant to part 15 of the FCC Rules. These limits are designed to provide reasonable protection against harmful interference in a residential installation.

This equipment generates radio frequency signal and, if not installed and used in accordance with the instructions, may cause harmful interference to radio communications. However, there is no guarantee that interference will not occur in a particular installation. If this equipment does cause harmful interference to radio or television reception, which can be determined by turning the equipment off and on, the user is encouraged to try to correct the interference by one or more of the following measures:

- Reorient or relocate the receiving antenna.
- Increase the separation between the equipment and receiver.
- Connect the equipment into an outlet on a circuit different from that to which the receiver is connected.
- Consult the dealer or an experienced radio/TV technician for help.

CE Declaration of Conformity

The DVS series switches are CE certificated products, they could use in any kind of the environments under CE environment specification. For keeping more safe application, we strongly suggest to use the CE-compliant industrial enclosure products.

1.1 Features

Thank you for purchasing the DVS Unmanaged Industrial Ethernet Switches. The DVS series switches including 5, 8, and 16-port smart switches. Except the DVS-005I00, The DVS series switches are equipped with the intelligent alarm function, and allow the wide range of operating temperature (-40 to 75°C). The DVS series switches are designed to support the application in any rugged environment and comply with UL, CE and FCC standards.

High Performance Network Technology

- 10/100Bas-T(X) (RJ45), 100Base-FX (SC/ST-Type Single/Multi mode)
- IEEE 802.3/802.3u/802.3x
- Auto negotiation speed
- Auto MDI/MDI-X

Industrial Grade Reliability

- Relay output port support power failure, port break alarm
- Redundant dual DC power inputs

Robust Design

- DVS-005I00/ 008I00/ 005I00A/ 008I00A operating temperature range is from -10 to 60°C, other DVS switches could extend operating temperature from -40 to 75°C.
- IP40, high-strength aluminum case
- Support DIN-Rail and Wall mounting

1.2 Package Checklist

DVS switches include the following items, if there are any of these items missing or damaged,

please contact your customer service representative for assistance.

- Delta DVS Unmanaged Ethernet Switch
- Instruction Sheet
- Wall mounting Plate
- Protective Caps for unused RJ45 ports



MEMO

1

Chapter 2 Hardware Description



Table of Contents

2.1	Panel Layout	2-2
2.2	Dimension	2-24
2.3	LED Indicators	2-25
2.4	Wiring the Redundant Power Inputs	2-26
2.5	Wiring the Alarm Contact	2-27
2.6	Ethernet Interface	2-27
2.7	DIP Switch Setting	2-28

2.1 Panel Layout

DVS-005I00

Front Panel

2

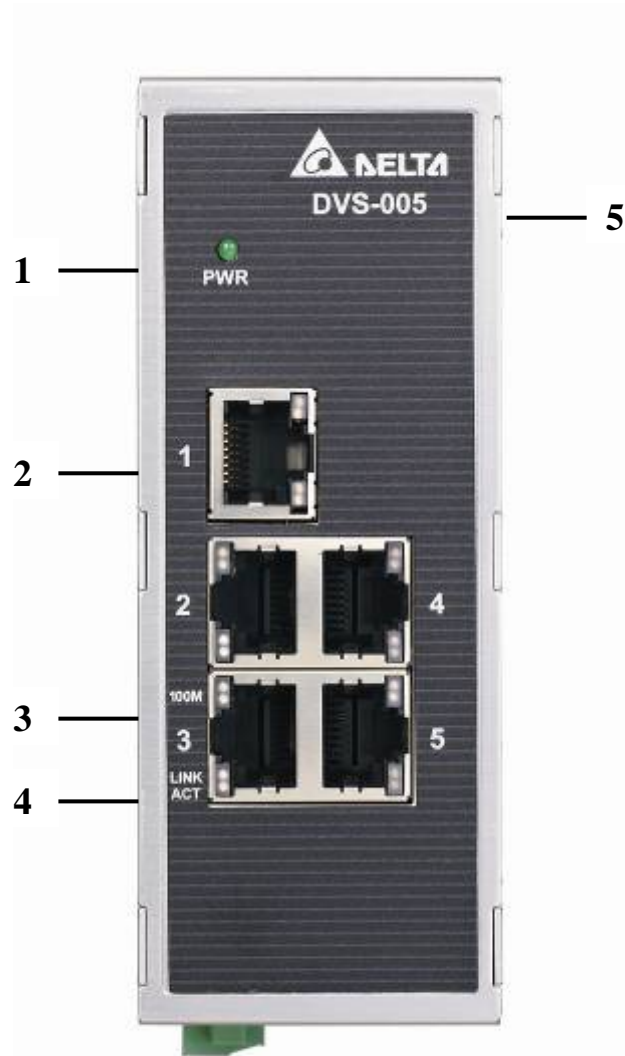

1	Power LED	4	LINK/ACT LED
2	Ethernet port	5	Series model name
3	Speed LED		

Bottom panel

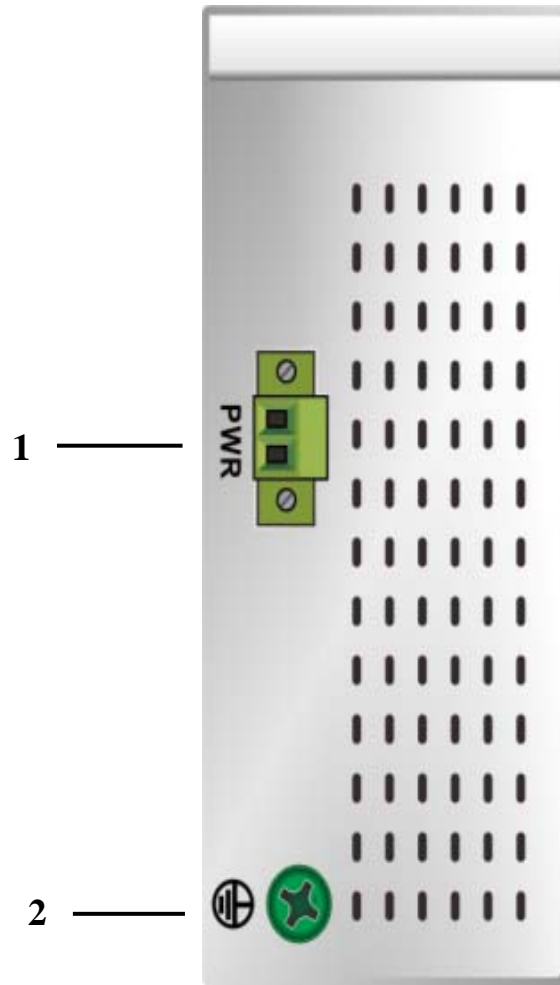

2

1 Terminal Block of PWR

2 Grounding screw

DVS-G005I00A

Front Panel

2

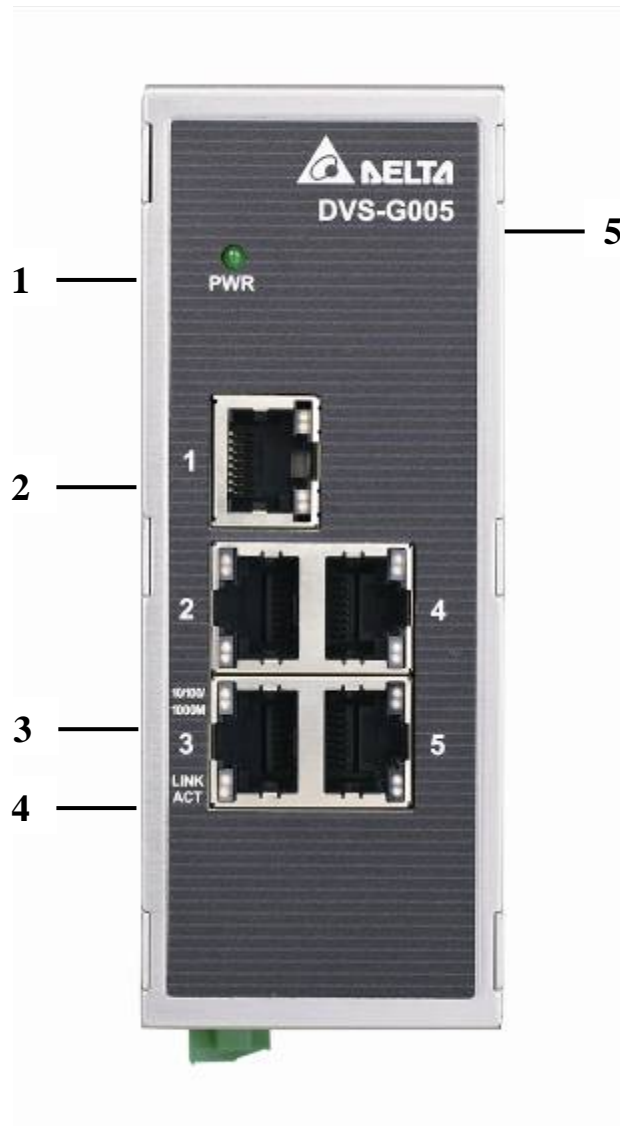

1	Power LED	4	LINK/ACT LED
2	Ethernet port	5	Series model name
3	Speed LED		

Bottom panel

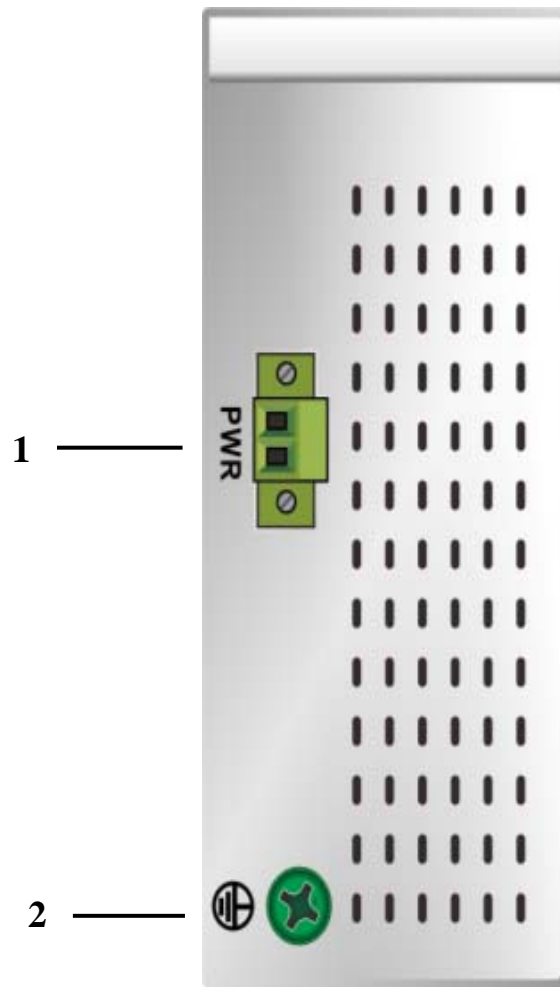

2

1 Terminal Block of PWR

2 Grounding screw

DVS-005W01

Front Panel

2

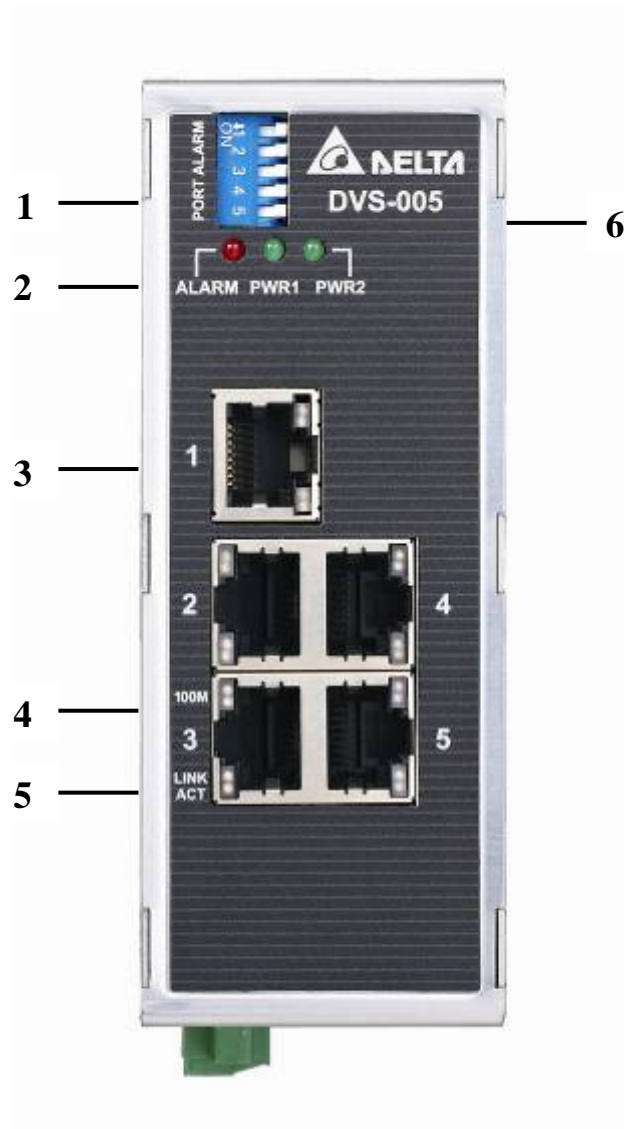

1	Event alarm DIP Switch	4	Speed LED
2	LED (ALARM / PWR1 / PWR2)	5	LINK/ACT LED
3	Ethernet port	6	Series model name

Bottom panel

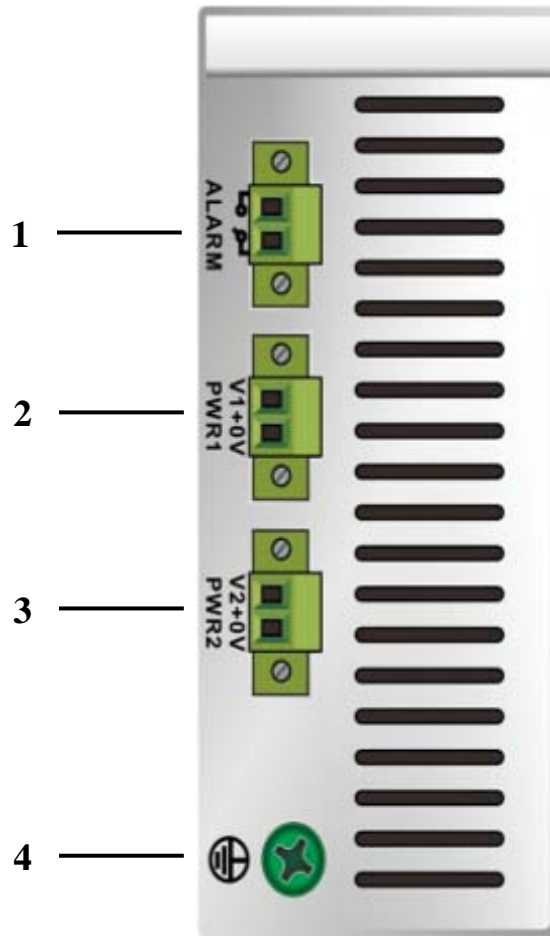

1	Terminal block of alarm output	3	Terminal block of PWR2
2	Terminal Block of PWR1	4	Grounding screw

DVS-005W01-MC01 / DVS-005W01-SC01

Front Panel

2

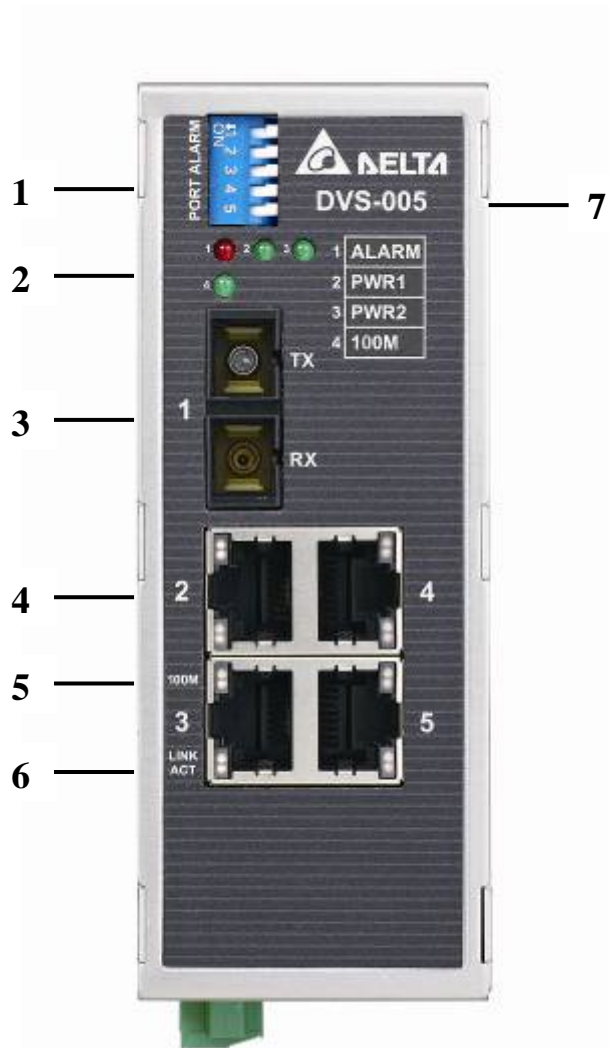

1	Event alarm DIP Switch	5	Speed LED
2	LED (ALARM / PWR1 / PWR2 / Fiber port speed LED)	6	LINK/ACT LED
3	Fiber Ethernet port	7	Series model name
4	Ethernet port		

Bottom panel

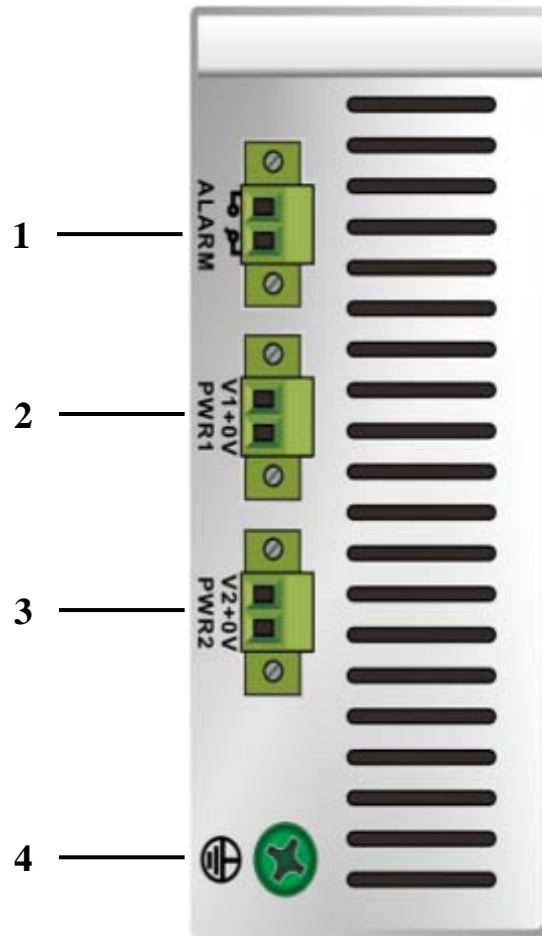

2

1	Terminal block of alarm output	3	Terminal Block of PWR2
2	Terminal Block of PWR1	4	Grounding screw

DVS-008I00

Front Panel

2

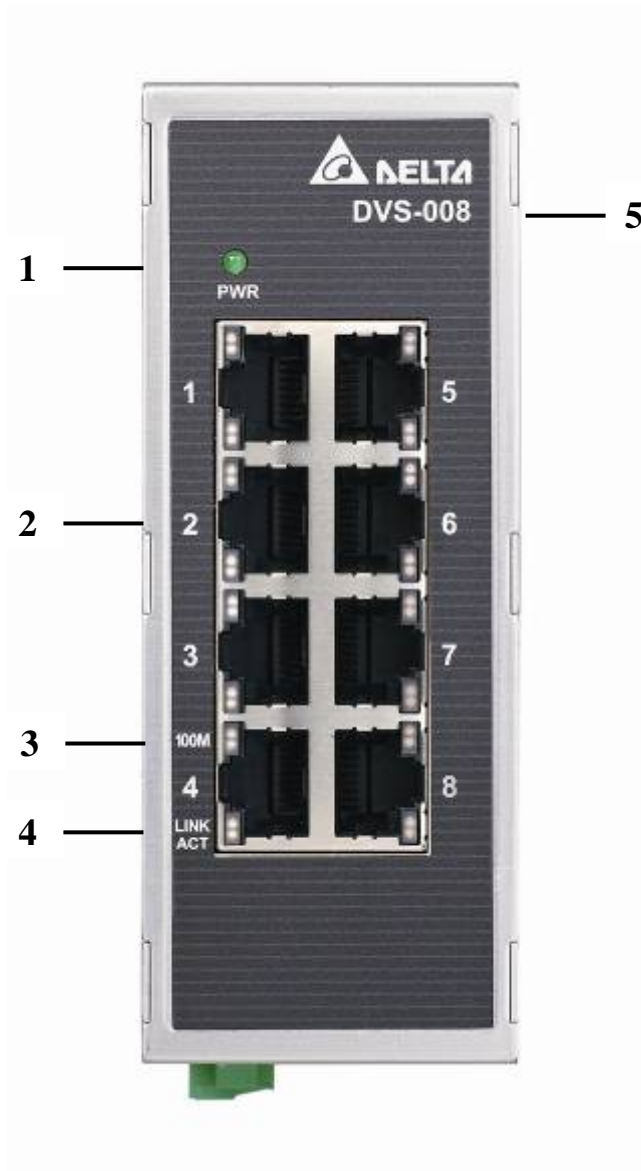

1	Power LED	4	LINK/ACT LED
2	Ethernet port	5	Series model name
3	Speed LED		

Bottom panel

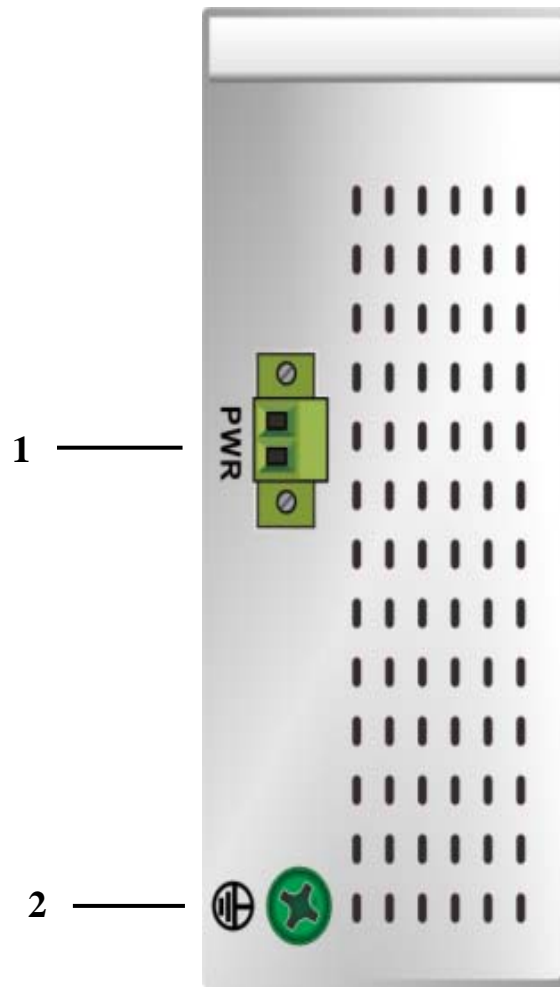

2

1 Terminal Block of PWR

2 Grounding screw

DVS-G008I00A

Front Panel

2

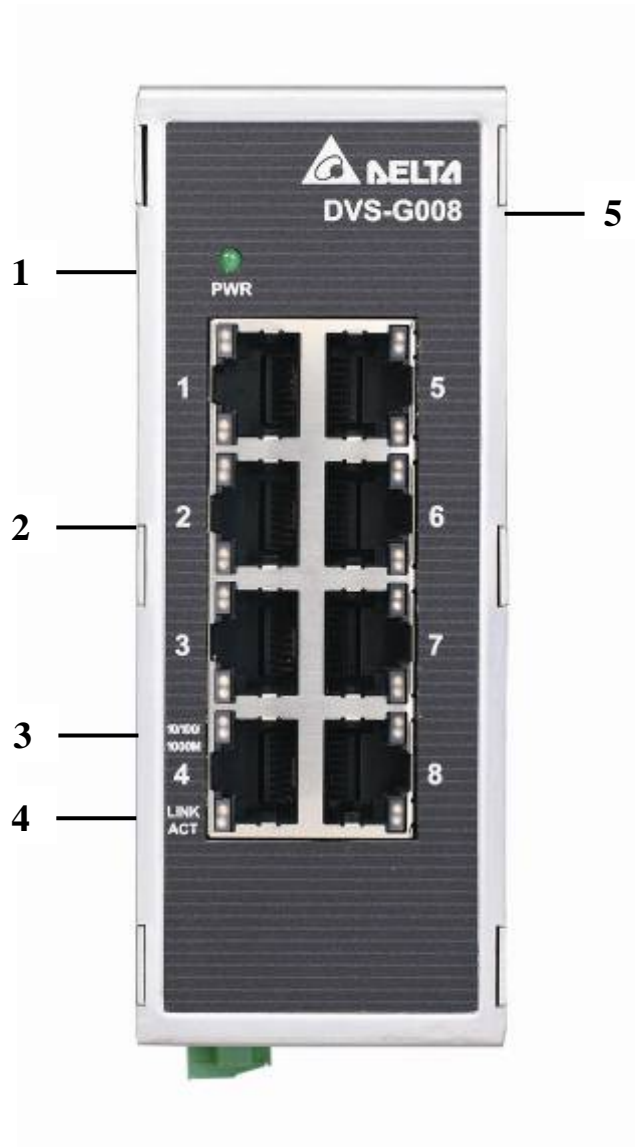

1	Power LED	4	LINK/ACT LED
2	Ethernet port	5	Series model name
3	Speed LED		

Bottom panel

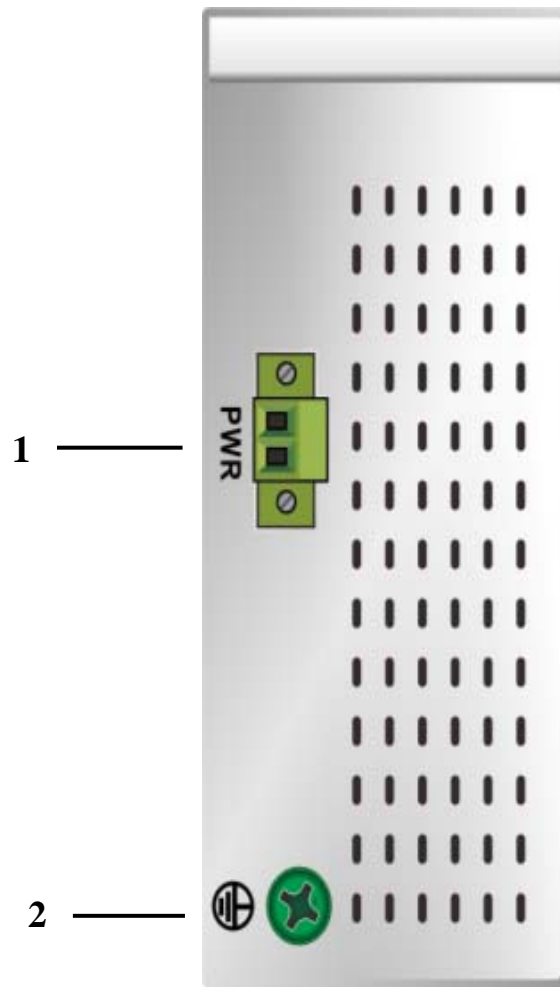

2

1 Terminal Block of PWR

2 Grounding screw

DVS-008W01

Front Panel

2

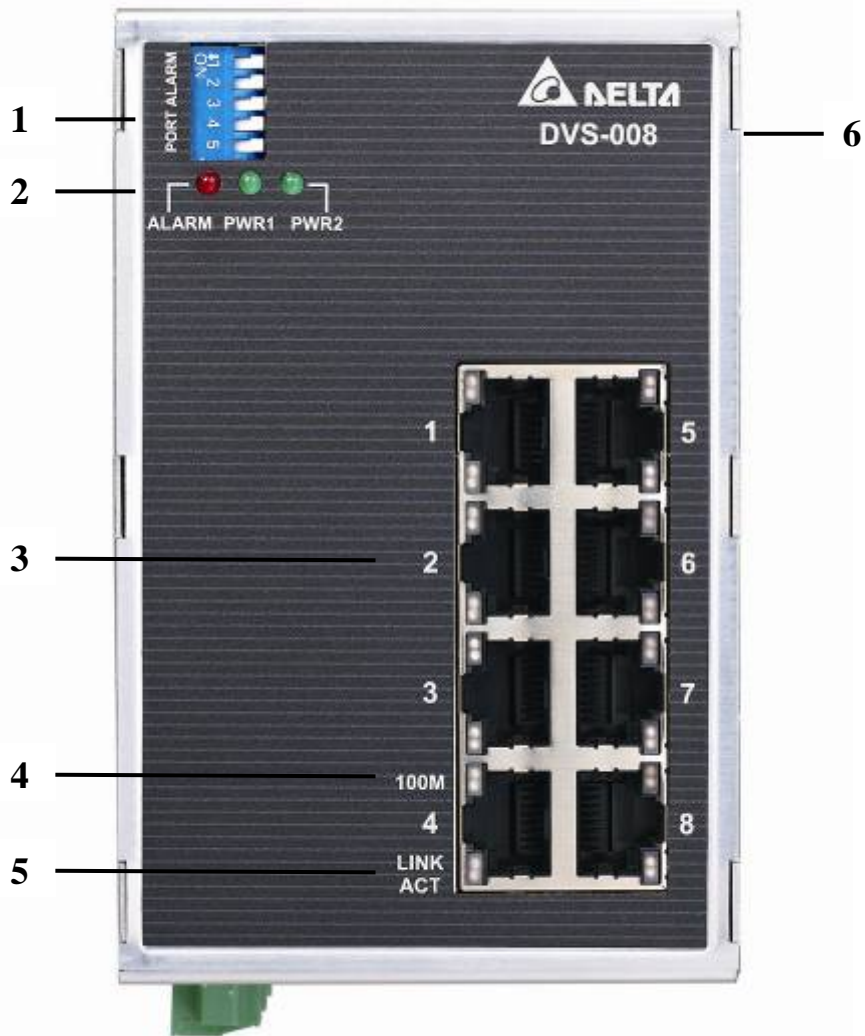

1	Event alarm DIP Switch	4	Speed LED
2	LED (ALARM / PWR1 / PWR2)	5	LINK/ACT LED
3	Ethernet port	6	Series model name

Bottom panel

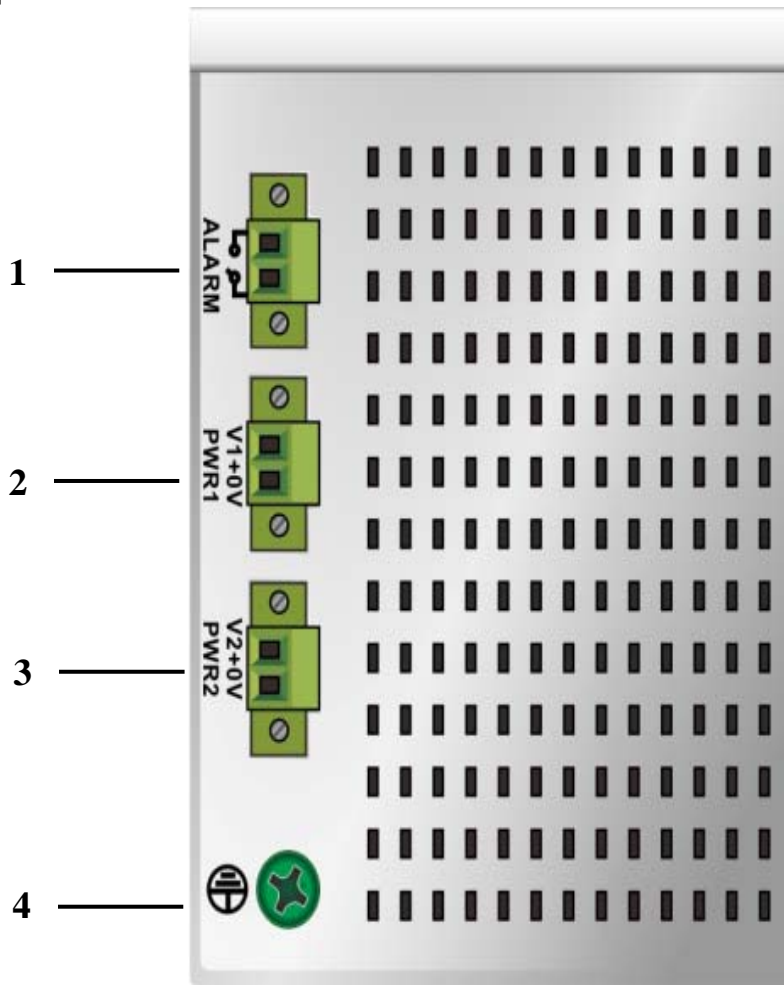

2

1	Terminal block of alarm output	3	Terminal Block of PWR2
2	Terminal Block of PWR1	4	Grounding screw

DVS-008W01-MC01 / DVS-008W01-SC01

Front Panel

2

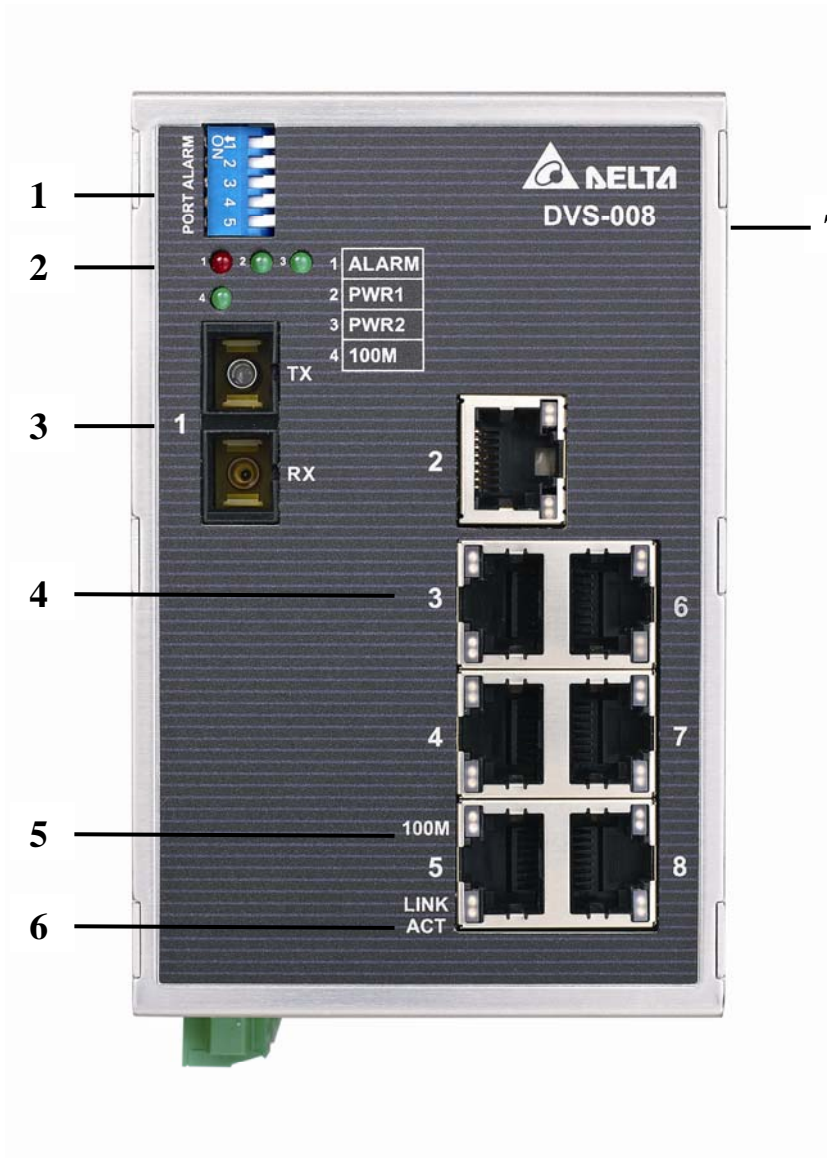

1	Event alarm DIP Switch	5	Speed LED
2	LED (ALARM / PWR1 / PWR2 / Fiber port speed LED)	6	LINK/ACT LED
3	Fiber Ethernet port	7	Series model name
4	Ethernet port		

Bottom panel

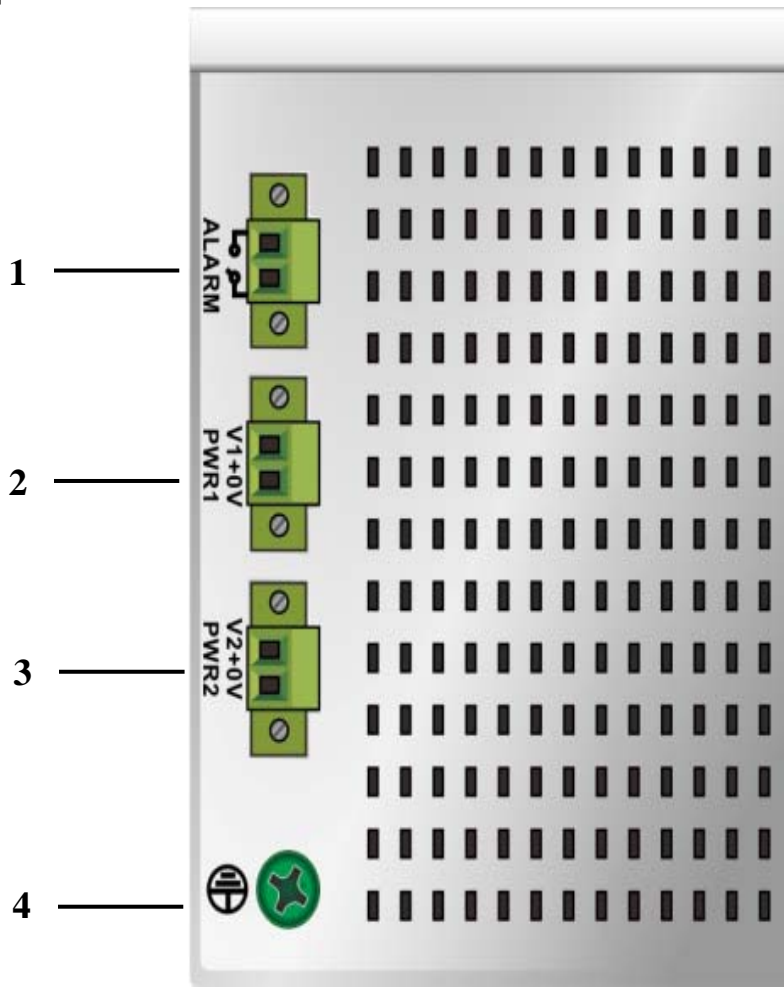

2

1	Terminal block of alarm output	3	Terminal Block of PWR2
2	Terminal Block of PWR1	4	Grounding screw

DVS-008W01-MC02 / DVS-008W01-SC02

Front Panel

2

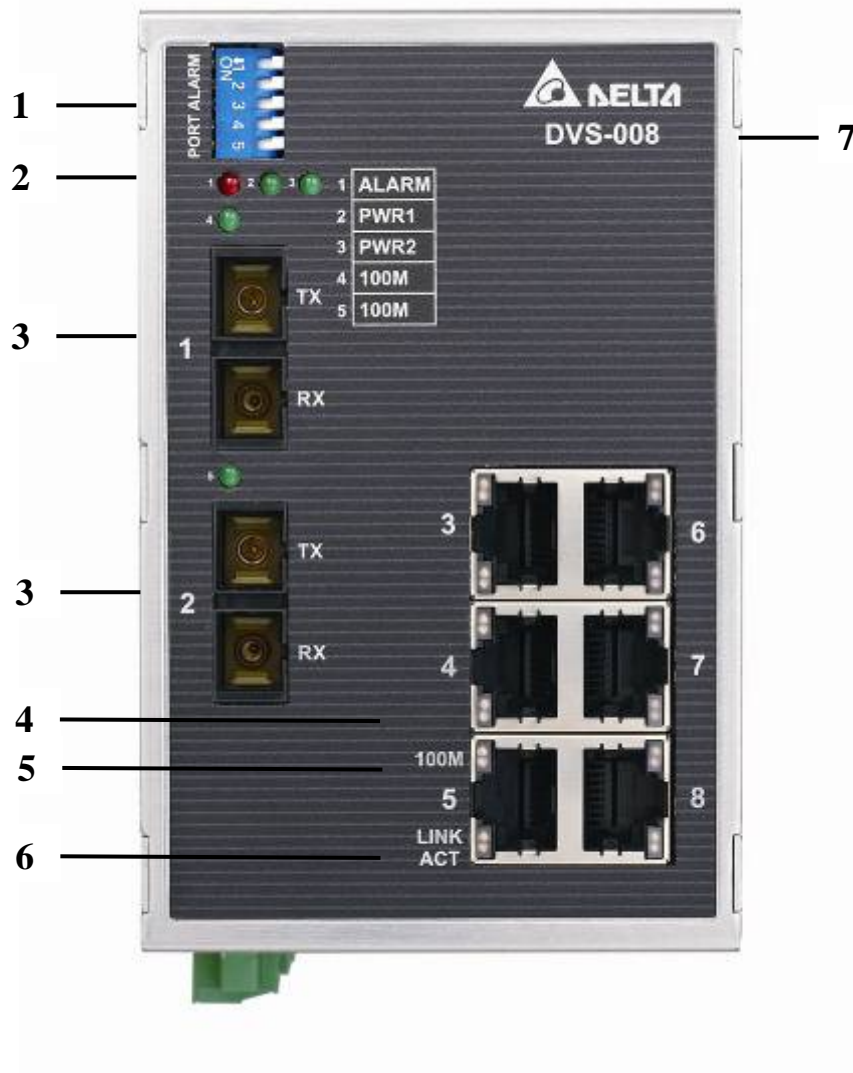

1	Event alarm DIP Switch	5	Speed LED
2	LED (ALARM / PWR1 / PWR2 / Fiber port speed LED)	6	LINK/ACT LED
3	Fiber Ethernet port	7	Series model name
4	Ethernet port		

Bottom panel

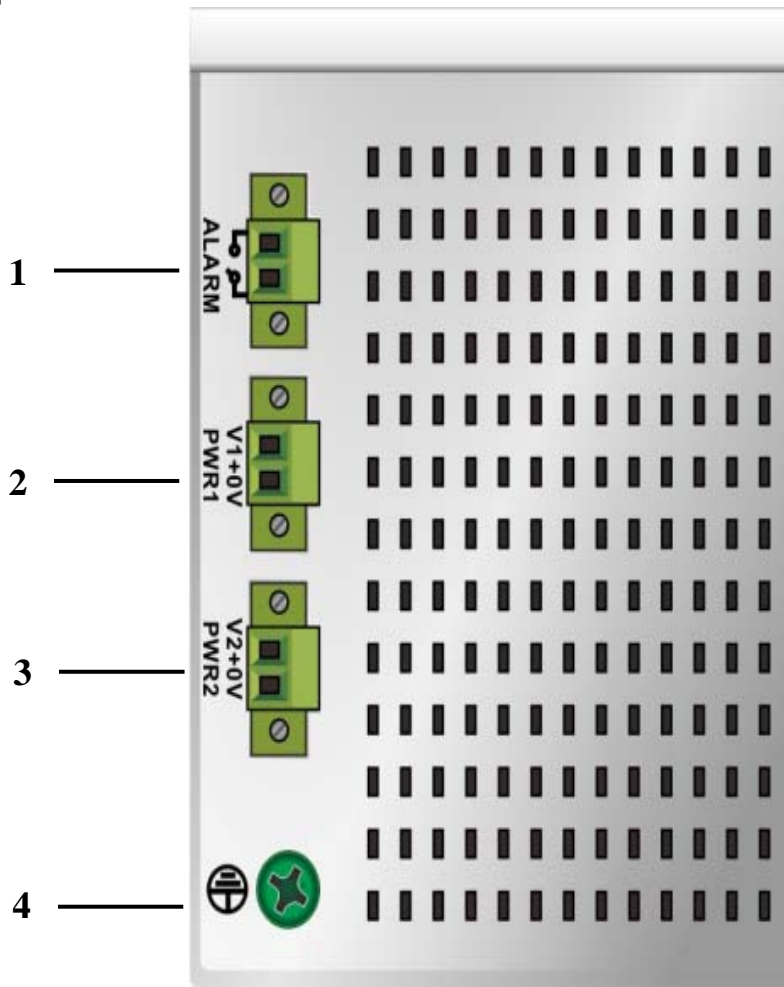

2

1	Terminal block of alarm output	3	Terminal Block of PWR2
2	Terminal Block of PWR1	4	Grounding screw

DVS-016W01

Front Panel

2

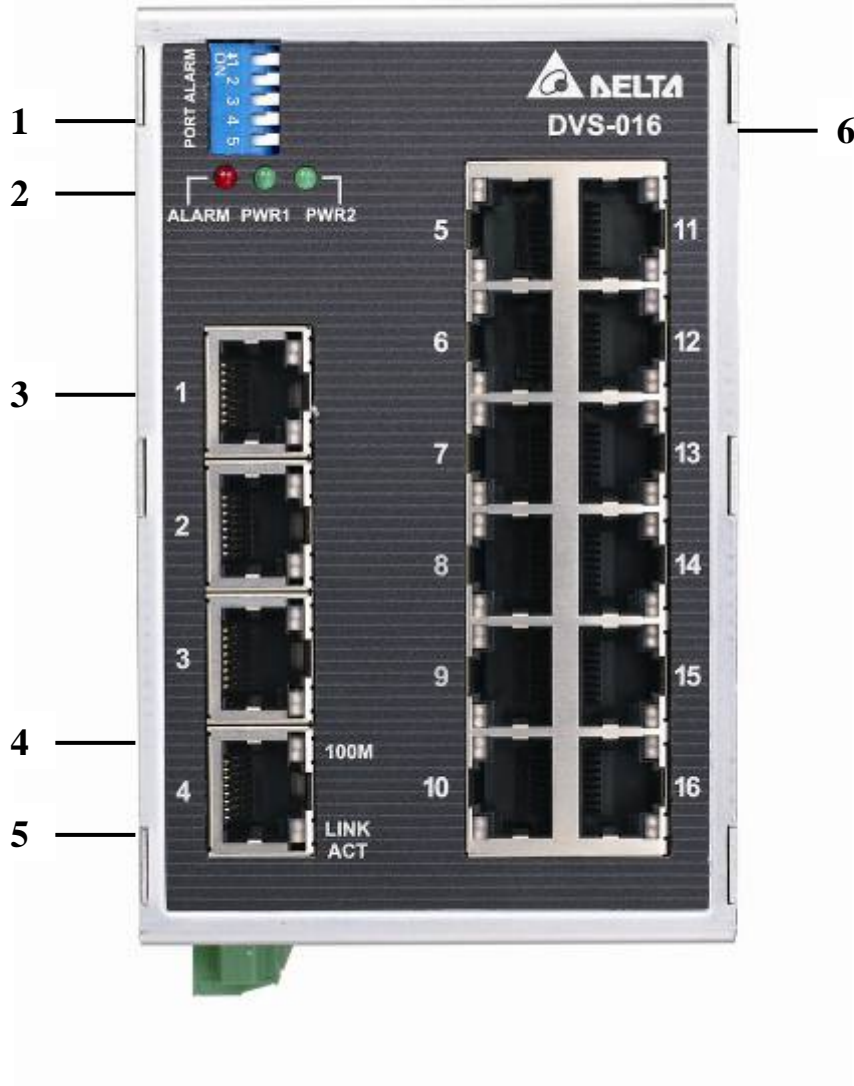

1	Event alarm DIP Switch	4	Speed LED
2	LED (ALARM / PWR1 / PWR2)	5	LINK/ACT LED
3	Ethernet port	6	Series model name

Bottom panel

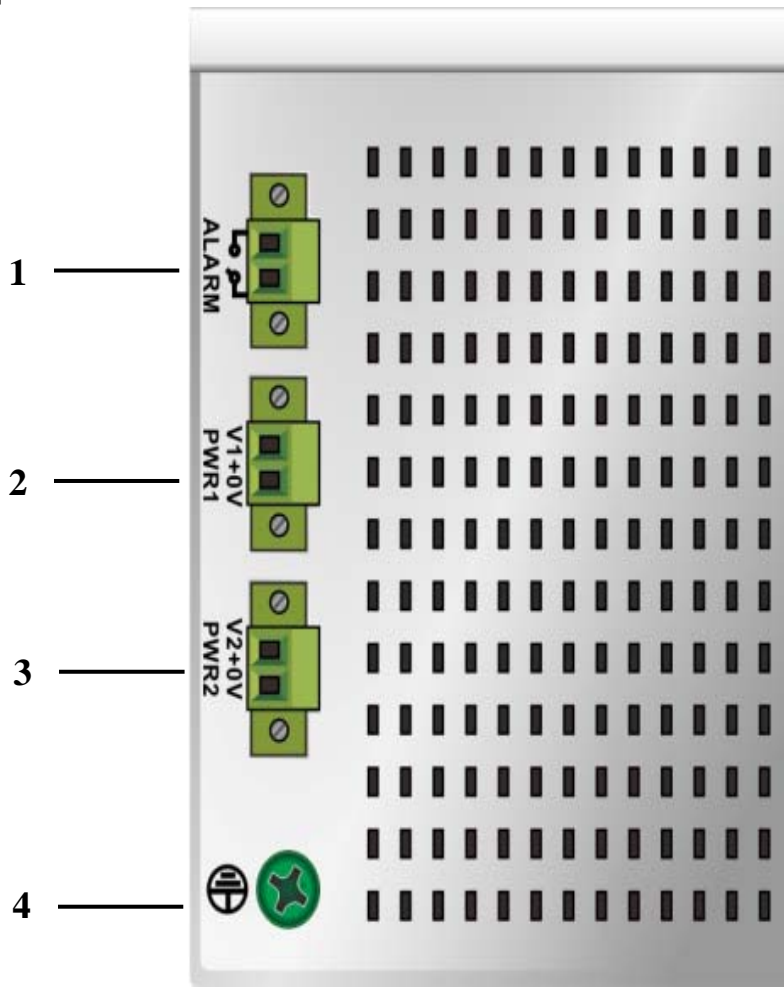

1	Terminal block of alarm output	3	Terminal Block of PWR2
2	Terminal Block of PWR1	4	Grounding screw

DVS-016W01-MC01 / DVS-016W01-SC01

Front Panel

2

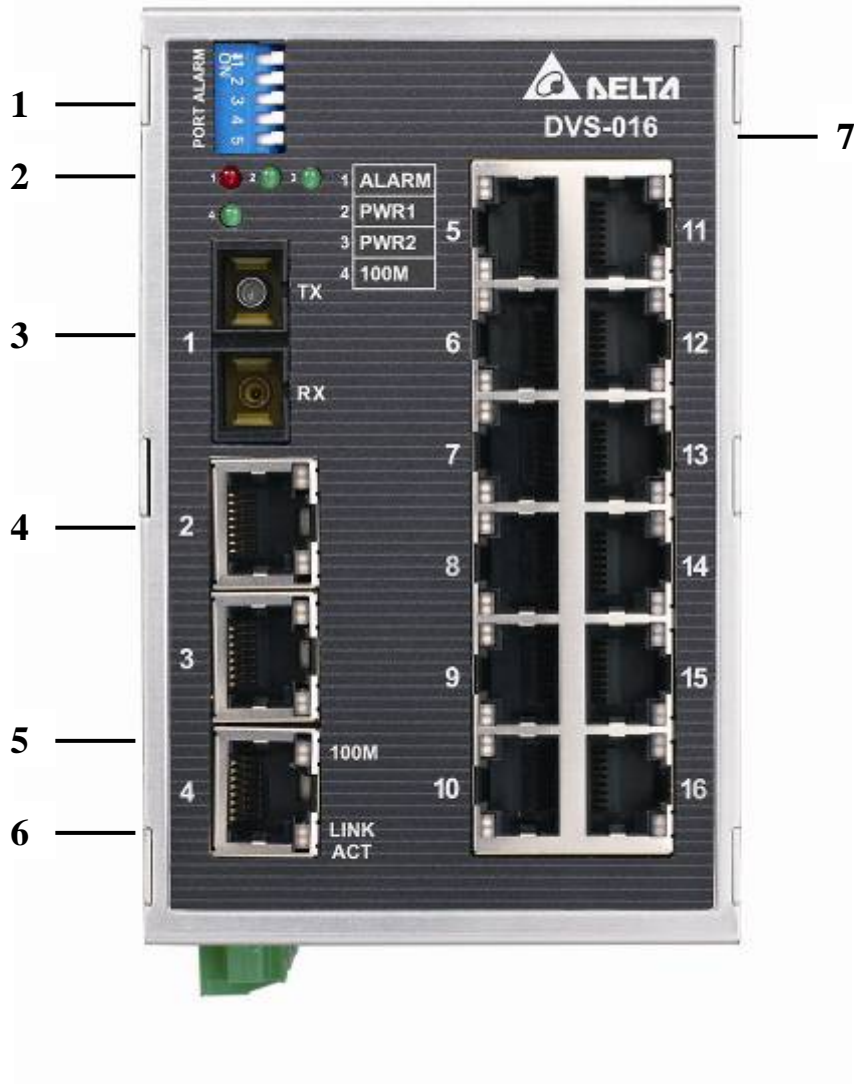

1	Event alarm DIP Switch	5	Speed LED
2	LED (ALARM / PWR1 / PWR2 / Fiber port speed LED)	6	LINK/ACT LED
3	Fiber Ethernet port	7	Series model name
4	Ethernet port		

Bottom panel

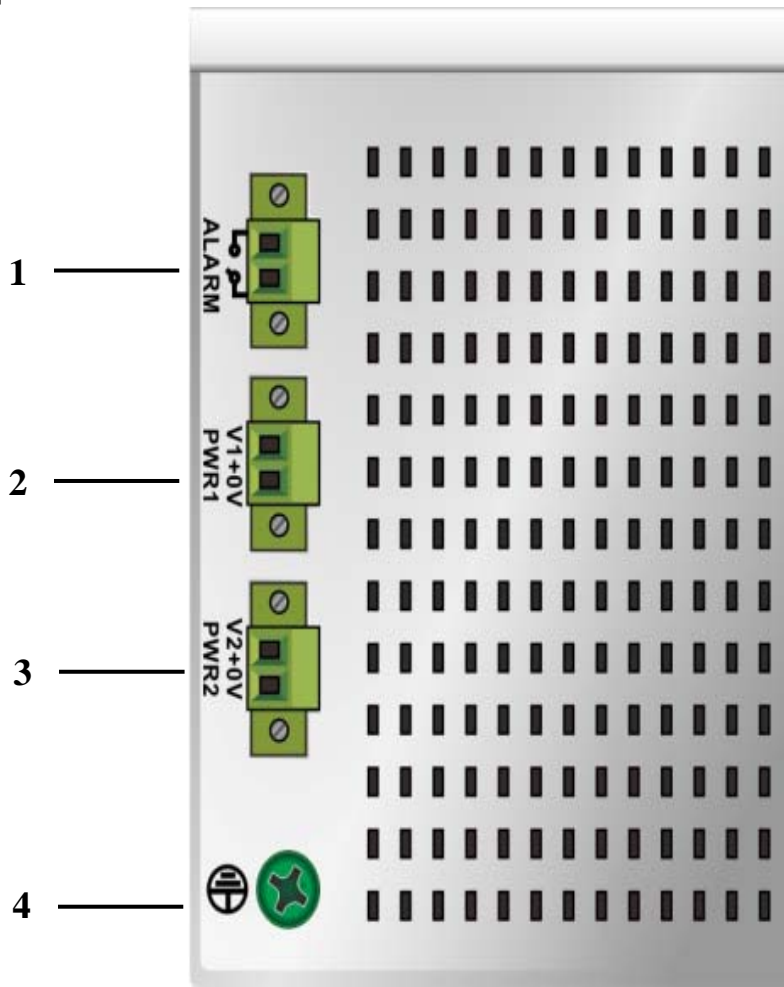

2

1	Terminal block of alarm output	3	Terminal Block of PWR2
2	Terminal Block of PWR1	4	Grounding screw

2.2 Dimension

DVS-005I00/DVS-008I00/G005I00A/G008I00A /005W01/005W01-MC01/005W01-SC01

2

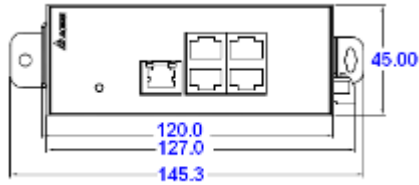
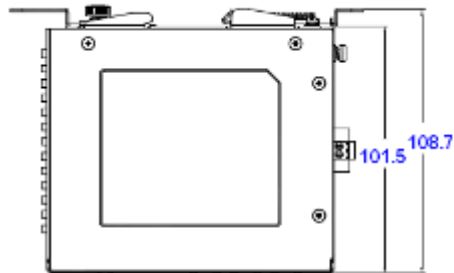

145.3(H) x 45(W) x 108.7(D) mm

DVS-008W01/008W01-MC01/008W01-SC01/008W01-MC02/008W01-SC02

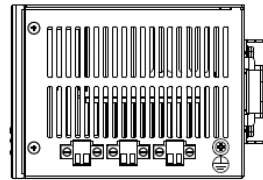
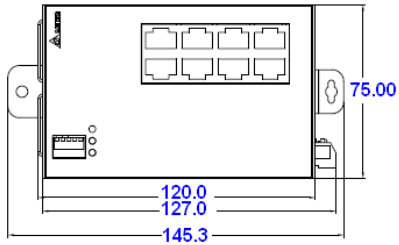
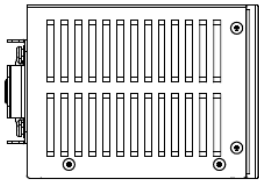
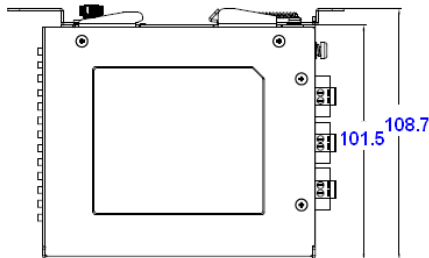

145.3(H) x 75(W) x 108.7(D) mm

DVS-016W01/016W01-MC01/016W01-SC01

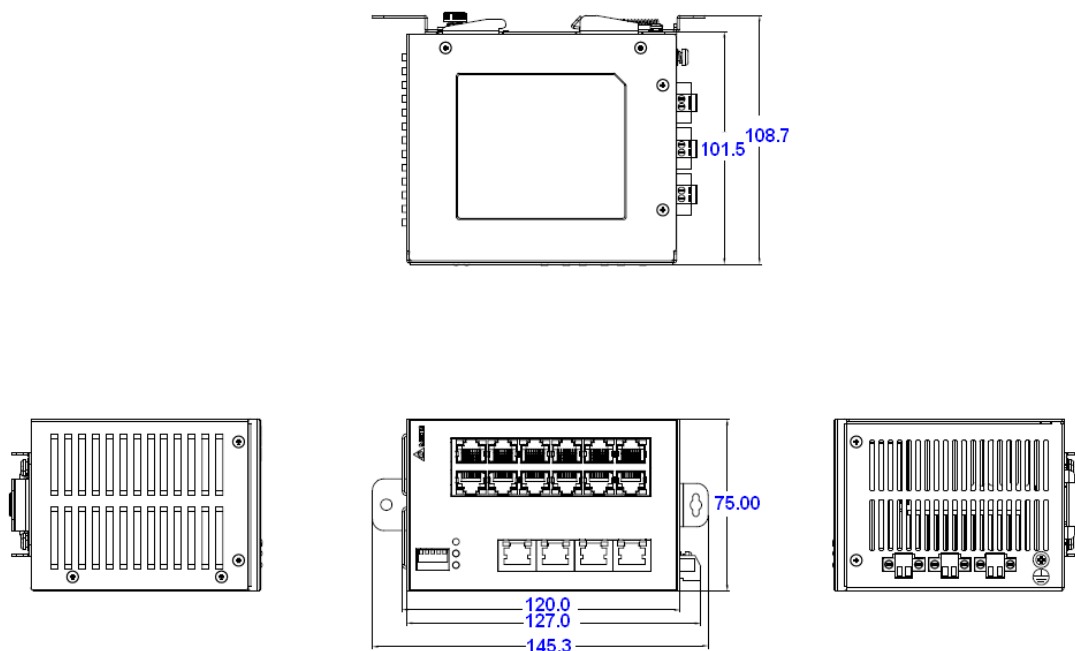

145.3(H) x 75(W) x 108.7(D) mm

2.3 LED Indicators

DVS-005I00 / DVS-008I00 / G005I00A / G008I00A

LED	Color	Status	Description
PWR	Green	ON	The power is supplied normally.
		OFF	The power is not supplied.
100M	Orange	ON	The port is connected at a speed of 100 Mbps.
		OFF	The port is connected at a speed of 10 Mbps or disconnected.
10/100/1000M	Green	ON	The port is connected at a speed of 1000Mbps.
	Orange	ON	The port is connected at a speed of 100Mbps.
	OFF	OFF	The port is connected at a speed of 10 Mbps or disconnected.
LINK/ACT	Green	ON	The Network communication connection has been established.
		Blinking	The data is being transmitted.
		OFF	The Network communication connection has not been established.

DVS-005W01 / DVS-008W01 / DVS-016W01

LED	Color	Status	Description
ALARM	Red	ON	The communication is interrupted, or there is a power failure.
		OFF	The communication is not interrupted, or there is no power failure. The DIP switch is not enabled.
PWR1	Green	ON	The power is supplied normally.
		OFF	The power is not supplied.
PWR2	Green	ON	The power is supplied normally.
		OFF	The power is not supplied.
100M	Orange	ON	The port is connected at a speed of 100 Mbps.
		OFF	The port is connected at a speed of 10 Mbps or disconnected.
LINK/ACT	Green	ON	The Network communication connection has been established.
		Blinking	The data is being transmitted.

2

LED	Color	Status	Description
LINK/ACT	Green	OFF	The Network communication connection has not been established.

DVS-005W01-MC01 / DVS-005W01-SC01 / DVS-008W01-MC01 / DVS-008W01-SC01 /
 DVS-008W01-MC02 / DVS-008W01-SC02 / DVS-016W01-MC01 / DVS-016W01-SC01

LED	Color	Status	Description
ALARM	Red	ON	The communication is interrupted, or there is a power failure.
		OFF	The communication is not interrupted, or there is no power failure. The DIP switch is not enabled.
PWR1	Green	ON	The power is supplied normally.
		OFF	The power is not supplied.
PWR2	Green	ON	The power is supplied normally.
		OFF	The power is not supplied.
100M	Green	ON	The fiber port is connected at a speed of 100 Mbps.
		OFF	The fiber port is not connected.
100M (on the RJ45 port)	Orange	ON	The port is connected at a speed of 100 Mbps.
		OFF	The port is connected at a speed of 10 Mbps or disconnected.
LINK/ACT	Green	ON	The Network communication connection has been established.
		Blinking	The data is being transmitted.
		OFF	The Network communication connection has not been established.

2.4 Wiring the Redundant Power Inputs

Except the DVS-005100, the DVS series switches are equipped with two sets of DC input (PWR1 / PWR2). Both sets of DC input can be connected to a wide range of power sources (12 to 48VDC). If one power source fails, the other live source can work as a backup to ensure that the machine operates normally.

Step 1: Insert the negative and positive DC wires into the terminal block, and make sure that the positive DC wire is connected to V1+ or V2+, and that the negative DC wire is connected to 0V.

Step 2: To prevent the loose DC wires, tighten the wire clamp screws on the terminal block connector with the flat-blade screwdriver.



Step 3: Insert the plastic terminal block connector into the terminal block receptor on the DVS series switch.

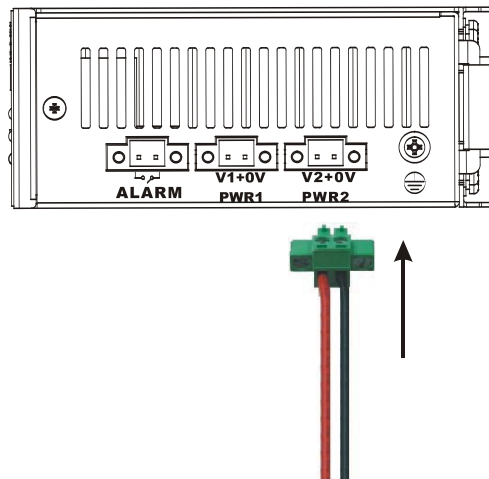

2.5 Wiring the Alarm Contact

The alarm contact is a dry relay. If one of the two power sources fails or the communication is interrupted, the contact will turn from an “OPEN” circuit to a “CLOSED” circuit. The relay can be connected to a 5A/24VDC power source.

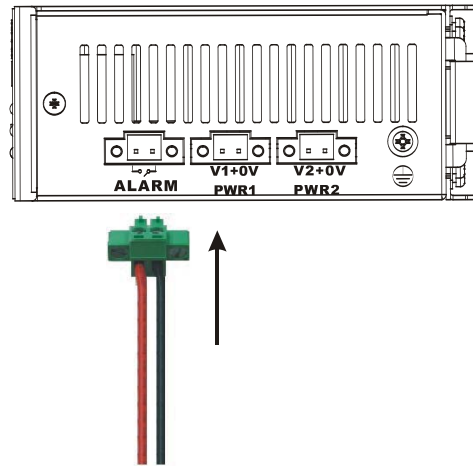

A typical way to use the alarm is to connect the Alarm circuit to a warning light or buzzer in the control room. The light or buzzer could be set up to turn on when any of the above two conditions is detected.

2.6 Ethernet Interface

10/100Base-T(X) Connection

The 10/100Base-T(X) ports of the DVS series switches are used to connect to Ethernet. They can support MDI (NIC-type) and MDI-X (HUB/Switch-type) modes, the pin definition of the Ethernet cable is as follows.

PIN	MDI Mode Definition	MDI-X Mode Definition	8-PIN RJ45 
1	Tx+	Rx+	
2	Tx-	Rx-	
3	Rx+	Tx+	
6	Rx-	Tx-	

10/100/1000Base-T Connection

The 10/100Base-T(X) or 10/100/1000Base-T ports of the DVS series switches are used to connect to Ethernet. RJ45 ports support MDI (NIC-type) and MDI-X (HUB/Switch-type) modes, the pin definition of the Ethernet cable is as follows.

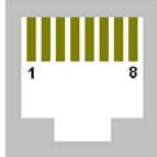
PIN	10/100Base-T(X)		1000Base-T	8-PIN RJ45 
	MDI Mode	MDI-X Mode	PIN	
1	Tx+	Rx+	TP0+	
2	Tx-	Rx-	TP0-	
3	Rx+	Tx+	TP1+	
4	n.c.	n.c.	TP2+	
5	n.c.	n.c.	TP2-	
6	Rx-	Tx-	TP1-	
7	n.c.	n.c.	TP3+	
8	n.c.	n.c.	TP3-	

100Base-FX Connection



**The products are US FDA CDRH AEL Class 1 product.
The output signal of the fiber port will damage the eyes
Do not look directly at the fiber port.**

2

In your fiber connection application, the RX port of DVS switches must connect to the TX port of the other fiber device and the TX port of DVS switches must connect to the RX port of the other fiber device.

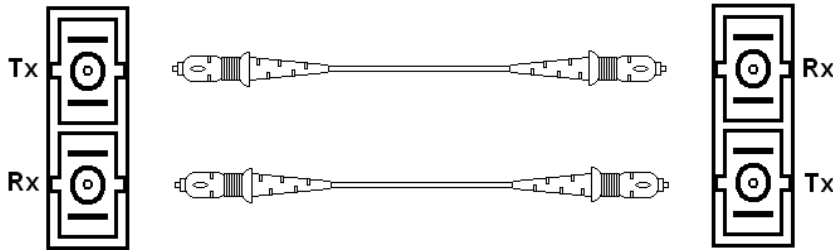

Fiber Optic Cable	Wavelength	Max TX power	Min TX power	RX Sensitivity	Optical Budget	Distance
MultiMode	1310nm	-14dBm	-20dBm(1) -22.5dBm(2)	-31dBm	11dBm(1) 8.5dBm(2)	2~5km
SingleMode	1310nm	-8dBm	-15dBm	-31dBm	16dBm	30km

Remark : (1) 62.5/125um fiber optic cable. (2) 50/125um fiber optic cable

IEEE standard transmission distance is 2km for 50/125um or 62.5um fiber optic cable. Actually, up to 2~5km distance is possible before dissipating the optical power budget of 8.5dBm~11dBm to a value below the Rx sensitivity. And 30km distance is possible before dissipating the optical power budget of 16dBm to a value below the Rx sensitivity.

2.7 DIP Switch Setting

ON:	After the corresponding switch of the port is enabled, when the communication is interrupted, the relay will form a "CLOSED" circuit, and the alarm LED will be on.	
OFF:	After the corresponding switch of the port is disabled, when the communication is interrupted, the relay still forms an "OPEN" circuit, and the alarm LED will not be on.	

3

Chapter 3 Installation

Table of Contents

3.1	DIN-Rail Mounting	3-2
3.2	Wall Mounting.....	3-3

3.1 DIN-Rail Mounting

The attached metal DIN-Rail plate should already be fixed to the rear panel of DVS switch when you get it. If you want to mount DVS switch with DIN-Rail, please make sure that the stiff metal spring is towards the top, as shown in the following figures,

Mounting

Step 1: Hook the upper end of the DIN clip of the DVS series switch on the DIN-Rail.

Step 2: Lightly push the DVS series switch toward the DIN-Rail until they contact each other closely.

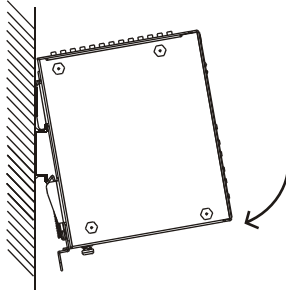

Removal

Step 1: Insert the flat-blade screwdriver into the DIN clip and pull the DIN clip downward.

Step 2: Pull the DVS series switch, and you can remove it from the DIN-Rail.

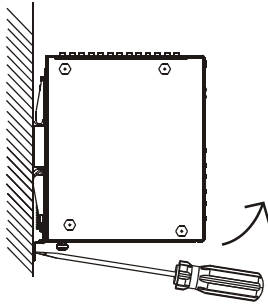

3.2 Wall Mounting

Step 1: Insert the wall mounting bracket into the slot on the rear panel of the DVS series switch, and tighten the screw on it, as shown in the diagram below.

Step 2: Place the wall mounting bracket in an appropriate position, and tighten the two screws on the bracket and the DIN clip.

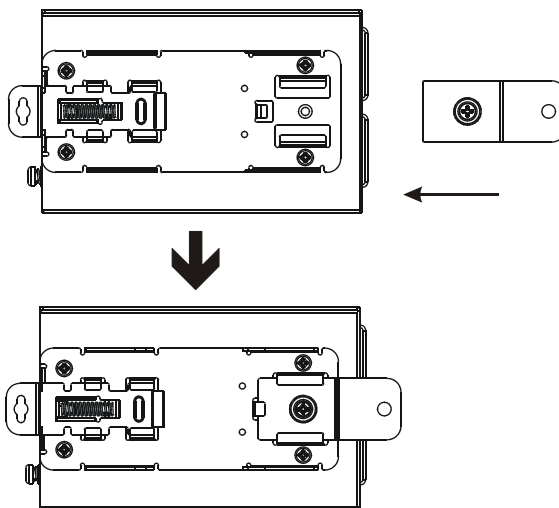

Please install the DVS with necessary airflow applied, and sufficient space around it to allow heat dissipation.

3

Chapter 4 Functional Description



Table of Contents

4.1	Auto MDI/MDI-X Connection	4-2
4.2	Auto-Negotiation and Speed Sensing.....	4-2
4.3	Stored and Forward.....	4-2
4.4	Addresses Capability and Learning.....	4-2
4.5	Quality of Service and VLAN Tagging.....	4-2
4.6	Broadcast Control.....	4-2

4.1 Auto MDI /MDI-X Connection

The Auto MDI/MDI-X function let users connect DVS switches' 10/100Base-T(X) ports to any kind of Ethernet device. You don't need to pay attention to the type of Ethernet cable being used for the connection. This means that you can use either a straight-forward cable or cross-over cable to connect DVS switches to Ethernet device.

4.2 Auto-Negotiation and Speed Sensing

All of DVS switch's RJ45 Ethernet ports could independently support auto-negotiation for speeds in the 10BaseT and 100Base-T(X) modes, with operation according to the IEEE 802.3u standard. It means that it could support some ports operating in 10 Mbps and the others ports operating in 100Mbps in the same time.

Auto-negotiation happens when a RJ45 cable connection is made, and then each time a LINK is enabled, DVS switches advertises its capability for using either 10Mbps or 100Mbps transmission speeds, with the device at the other end of the cable expected to similarly advertise. Depending on what type of device is connected, this will result in agreement to operate in a speed of either 10Mbps or 100Mbps.

4

4.3 Stored and Forward

DVS switches could support the packet size between 64 bytes to 1522 bytes. They could store the traffic packets when the buffer of the receiver device in the other size of the internet line is full. DVS switches could store the packages until the receiver device could process the new package, DVS switches will restart to send the stored package to the receiver.

4.4 Addresses Capability and Learning

DVS switches has address learning engine to learn the source address of ingress frames. Up to 8K MAC addresses and port number mappings can be stored in the address database. When a new MAC address found that is not in the MAC address mapping database. DVS switches could self-learning the message of the MAC address and place it into the MAC database. It means that DVS switches could automatically support more internet devices in the application.

4.5 Quality of Service and VLAN Tagging

DVS switches has another feature that is different from other unmanaged switches, that is DVS switches could support high speed and non-blocking to transfer the packets with VLAN tagging or the 4 traffic classes QoS packet. The priority from high to low is 7 to 0. The 4 sets priorities are "7,6", "5,4", "3,0", "2,1". The highest level priorities are 7 and 6 for the application as RIP and OSPF protocol routing updated. The priority "5,4" is for the delay-sensitive application as video and audio application. The priority "3,0" is for the control-load application as streaming multi-media and business critical traffic application. The priority "2,1" is the lowest priority for the application that don't need any application setting. This feature could let the network application be more flexible and it will not limit the networks setting cause of the packet types.

4.6 Broadcast Control

When some network device work abnormal, it maybe will send out to many broadcast packets and it maybe will paralysis the Ethernet traffic. DVS-008/016W series have Broadcast control function, this feature could limit the broadcast packet traffic under the 10% full speed packet traffic and it could avoid the abnormal broadcast packet to paralysis the Ethernet traffic and the user has more stable Ethernet environment.